

Specifications and Contract Documents

Prepared for the City of



***Novelis Sanitary Sewer Extension Project
Contract No. 1 (Gravity Sewer)***

A. Scott Marshall
Mayor

City Council

Harry Green Terri Tilghman-Douglas
Norma Williams Pam Turner
Jimmy Covington Mary Charles King

Prepared by

MCGHEE ENGINEERING, INC.
202 Ewing Street, P. O. Box 267
Guthrie, Kentucky 42234
(270) 483-9985

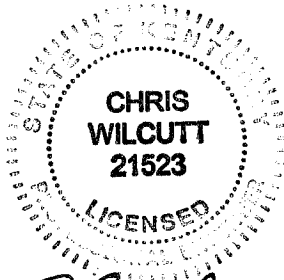

Chris Wilcutt
10/22/18

City of Guthrie, Kentucky
NOVELIS SANITARY SEWER PROJECT: CONTRACT 1 – GRAVITY SEWER
CONTRACT DOCUMENTS

Table of Contents

| <u>Bidding Documents</u> | <u>Pages</u> |
|--|---------------------|
| Advertisement for Bids | 1 |
| Instructions to Bidders | 12 |
| Bid Bond (EJCDC C-430) | 2 |
| Bid Form (EJCDC C-410) | 6 |
| Statement of Experience | 1 |
| Certification for Contracts, Grants and Loans (RD 1940-Q) | 1 |
| Certification Regarding Debarment, etc (AD 1048) | 2 |
| Compliance Statement (RD 400-6) | 2 |
| | |
| <u>Agreement Section</u> | |
| Notice of Award | 1 |
| Agreement (EJCDC C-520) | 6 |
| Performance Bond (EJCDC C-610) | 3 |
| Payment Bond (EJCDC C-615) | 3 |
| Power of Attorney (Provided by Contractor) | - |
| Notice to Proceed | 1 |
| Certificate of Insurance (Provided by Contractor) | - |
| | |
| <u>Conditions Section</u> | |
| General Conditions (EJCDC C-700) | 66 |
| Certificate of Owner's Attorney & Funding Agency Concurrence | 1 |
| Supplementary Conditions | 24 |
| Contract Change Order Form (RD 1924-7) | 1 |
| Project Sign Detail | 1 |
| Project Special Conditions | 3 |
| | |
| <u>Technical Specifications</u> | |
| 01-100 Summary of Work | 4 |
| 01-200 Submittals | 2 |
| 01-210 Materials Purchased Directly by Owner | 2 |
| 01-900 Construction Layout & Record Drawings | 2 |
| | |
| 02-100 Gravity Sewer General Requirements | 5 |
| 02-102 Clearing, Grubbing and Striping | 1 |
| 02-190 Gravity Sewer | 10 |
| 02-950 Measurement and Payment | 6 |
| | |
| <u>Appendix</u> | |
| Appendix 1 - KPDES Form NOI-SW (Notice of Intent for Storm Water Discharges) | |
| Appendix 2 – USDA Kentucky Bulletin info regarding American Iron & Steel (AIS Requirement) | |
| Appendix 3 – Miscellaneous Project Permits (Army Corp, KDOW, KYTC, CSX, USF&W, etc) | |
| | |
| <u>Contract Drawings</u> | |
| Contract Drawings consist of 6 sheets bound separately from this document. See the index on the cover sheet of the Contract Drawings. | |

ADVERTISEMENT FOR BIDS

City of Guthrie
P.O. Box 125
110 Kendall Street
Guthrie, KY 42234

RE: Novelis Sanitary Sewer Project: Contract No. 1 – Gravity Sewer

The **City of Guthrie** will receive separate, sealed Bids for their **Novelis Sanitary Sewer Project: Contract No. 1 – Gravity Sewer** until **1:30 p.m., Friday, February 1, 2019** at the office of Guthrie City Hall, 110 Kendall Street, P.O. Box 125, Guthrie, Kentucky 42234, at which time they will be publicly opened and read aloud.

The work to be performed involves the installation of nearly 3,300 LF of 12-inch gravity sewer extension plus other appurtenances to serve a new industrial user on US Highway 79 in Todd County (KY). Bids will be received for a single prime Contract. Bids shall be on a unit price basis.

The Issuing Office for the Bidding Documents is: McGhee Engineering, Inc., at P.O. Box 267, 202 South Ewing Street, Guthrie, Kentucky 42234 or by calling (270) 483-9985. Prospective Bidders may examine the Bidding Documents at the Issuing Office on Mondays through Fridays between the hours of 8:30-4:30 pm, and may obtain copies of the Bidding Documents from the Issuing Office as described below.

Plans must be ordered by visiting www.mcgheeengineering.com and clicking "**Bid Opportunities**". Plans will be sold with an option of Digital only OR Printed Set w/ Digital copy. Bids will be accepted only from registered contractors holding approved bid forms provided by the Issuing Office. Plan holders may be viewed at www.mcgheeengineering.com.

"Section 746 of Title VII of the Consolidated Appropriations Act of 2017 (Division A - Agriculture, Rural Development, Food and Drug Administration, and Related Agencies Appropriations Act, 2017) and subsequent statutes mandating domestic preference applies an American Iron and Steel requirement to this project. All listed iron and steel products used in this project must be produced in the United States. The term "iron and steel products" means the following products made primarily of iron or steel: lined or unlined pipes and fittings, manhole covers and other municipal castings, hydrants, tanks, flanges, pipe clamps and restraints, valves, structural steel, reinforced precast concrete, and construction materials. The de minimis and minor components waiver apply to this contract."

Bid security shall be furnished in accordance with the Instructions to Bidders.

Published by the authority of the City of Guthrie
 Jimmy Covington, Mayor

Dated: January 2, 2019

INSTRUCTIONS TO BIDDERS

A. These Instructions to Bidders establish requirements for Bidding and Award of Contract.

B. Table of Articles

Article 1 – Defined Terms

Article 2 – Copies of Bidding Documents

Article 3 – Qualifications of Bidders

Article 4 – Site and Other Areas; Existing Site Conditions; Examination of Site; Owner’s Safety Program;
Other Work at the Site

Article 5 – Bidder’s Representations

Article 6 – Pre-Bid Conference

Article 7 – Interpretations and Addenda

Article 8 – Bid Security

Article 9 – Contract Times

Article 10 – Liquidated Damages

Article 11 – Substitute and “Or-Equal” Items

Article 12 – Subcontractors, Suppliers, and Others

Article 13 – Preparation of Bid

Article 14 – Basis of Bid

Article 15 – Submittal of Bid

Article 16 – Modification and Withdrawal of Bid

Article 17 – Opening of Bids

Article 18 – Bids to Remain Subject to Acceptance

Article 19 – Evaluation of Bids and Award of Contract

Article 20 – Bonds and Insurance

Article 21 – Signing of Agreement

Article 22 – Retainage

Article 23 – Licenses, Fees & Taxes

Article 24 – Wage Rate Determination

Article 25 – Other Bid Requirements

Article 26 – Laws, Ordinances & Regulations

Article 27 – Insurance

Article 28 – Safety Standards & Accident Prevention

ARTICLE 1- DEFINED TERMS

Other terms used in the bidding documents and not defined elsewhere have the following meanings

which are applicable to both the singular and plural thereof.

1.01 Terms used in these Instructions to Bidders will have the meanings indicated in the General Conditions and the Supplementary Conditions. Additional terms used in these Instructions to Bidders have the meanings indicated below which are applicable to both the singular and plural thereof.

- A. Bidder - The individual or entity who submits a Bid directly to OWNER.
- B. Issuing Office - The office from which the Bidding Documents are to be issued.
- C. Successful Bidder - The lowest responsible Bidder submitting a responsive Bid to whom OWNER (on the basis of OWNER's evaluation as hereinafter provided) makes an award.

ARTICLE 2 - COPIES OF BIDDING DOCUMENTS

2.01 Complete sets of the Bidding Documents may be obtained from the Issuing Office in the number and format stated in the advertisement or invitation to bid.

2.02 Complete sets of Bidding Documents must be used in preparing Bids; neither OWNER nor ENGINEER assume any responsibility for errors or misinterpretations resulting from the use of incomplete sets of Bidding Documents.

2.03 OWNER and ENGINEER in making copies of Bidding Documents available on the above terms do so only for the purpose of obtaining Bids for the Work and do not confer a license or grant for any other use.

ARTICLE 3 - QUALIFICATIONS OF BIDDERS

3.01 To demonstrate Bidder's qualifications to perform the Work, after submitting its Bid and within **10** days of Owner's request, Bidder shall submit (a) written evidence establishing its qualifications such as financial data, previous experience, and present commitments, and (b) the following additional information:

- A. Evidence of Bidder's authority to do business in the state where the Project is located.
- B. Bidder's state or other contractor license number, if applicable.
- C. Subcontractor and Supplier qualification information; coordinate with provisions of Article 12 of these Instructions, "Subcontractors, Suppliers, and Others."

3.02 A Bidder's failure to submit required qualification information within the times indicated may disqualify Bidder from receiving an award of the Contract.

3.03 No requirement in this Article 3 to submit information will prejudice the right of Owner to seek additional pertinent information regarding Bidder's qualifications.

3.04 Bidder is advised to carefully review those portions of the Bid Form requiring Bidder's representations and certifications.

ARTICLE 4 - SITE AND OTHER AREAS; EXISTING SITE CONDITIONS; EXAMINATION OF SITE; OWNER'S SAFETY PROGRAM; OTHER WORK AT THE SITE

4.01 *Site and Other Areas*

- A. The Site is identified in the Bidding Documents. By definition, the Site includes rights-of-way, easements, and other lands furnished by Owner for the use of the Contractor. Any additional lands required for temporary construction facilities, construction equipment, or storage of materials and equipment, and any access needed for such additional lands, are to be obtained and paid for by Contractor.

4.02 *Existing Site Conditions*

A. Subsurface and Physical Conditions; Hazardous Environmental Conditions

1. The Supplementary Conditions identify:

- a. those reports known to Owner of explorations and tests of subsurface conditions at or adjacent to the Site.
- b. those drawings known to Owner of physical conditions relating to existing surface or subsurface structures at the Site (except Underground Facilities).
- c. reports and drawings known to Owner relating to Hazardous Environmental Conditions that have been identified at or adjacent to the Site.
- d. Technical Data contained in such reports and drawings.

- 2. Owner will make copies of reports and drawings referenced above available to any Bidder on request. These reports and drawings are not part of the Contract Documents, but the Technical Data contained therein upon whose accuracy Bidder is entitled to rely, as provided in the General Conditions, has been identified and established in the Supplementary Conditions. Bidder is responsible for any interpretation or conclusion Bidder draws from any Technical Data or any other data, interpretations, opinions, or information contained in such reports or shown or indicated in such drawings.

- 3. If the Supplementary Conditions do not identify Technical Data, the default definition of Technical Data set forth in Article 1 of the General Conditions will apply.

- B. Underground Facilities: Information and data shown or indicated in the Bidding Documents with respect to existing Underground Facilities at or adjacent to the Site are set forth in the Contract Documents and are based upon information and data furnished to Owner and Engineer by owners of such Underground Facilities, including Owner, or others.

- C. Adequacy of Data: Provisions concerning responsibilities for the adequacy of data furnished to prospective Bidders with respect to subsurface conditions, other physical conditions, and Underground Facilities, and possible changes in the Bidding Documents due to differing or unanticipated subsurface or physical conditions appear in Paragraphs 5.03, 5.04, and 5.05 of the General Conditions. Provisions concerning responsibilities for the adequacy of data furnished to prospective Bidders with respect to a Hazardous Environmental Condition at the Site, if any, and possible changes in the Contract Documents due to any Hazardous Environmental Condition uncovered or revealed at the Site which was not shown or indicated in the Drawings or Specifications or identified in the Contract Documents to be within the scope of the Work, appear in Paragraph 5.06 of the General Conditions.

4.03 *Site Visit and Testing by Bidders*

- A. Bidder shall conduct the required Site visit during normal working hours, and shall not disturb any ongoing operations at the Site.

- B. Bidder is not required to conduct any subsurface testing, or exhaustive investigations of Site conditions.
- C. On request, and to the extent Owner has control over the Site, and schedule permitting, the Owner will provide Bidder access to the Site to conduct such additional examinations, investigations, explorations, tests, and studies as Bidder deems necessary for preparing and submitting a successful Bid. Owner will not have any obligation to grant such access if doing so is not practical because of existing operations, security or safety concerns, or restraints on Owner's authority regarding the Site.
- D. Bidder shall comply with all applicable Laws and Regulations regarding excavation and location of utilities, obtain all permits, and comply with all terms and conditions established by Owner or by property owners or other entities controlling the Site with respect to schedule, access, existing operations, security, liability insurance, and applicable safety programs.
- E. Bidder shall fill all holes and clean up and restore the Site to its former condition upon completion of such explorations, investigations, tests, and studies.

4.04 *Owner's Safety Program*

- A. Site visits and work at the Site may be governed by an Owner safety program. As the General Conditions indicate, if an Owner safety program exists, it will be noted in the Supplementary Conditions.

4.05 *Other Work at the Site*

- A. Reference is made to Article 8 of the Supplementary Conditions for the identification of the general nature of other work of which Owner is aware (if any) that is to be performed at the Site by Owner or others (such as utilities and other prime contractors) and relates to the Work contemplated by these Bidding Documents. If Owner is party to a written contract for such other work, then on request, Owner will provide to each Bidder access to examine such contracts (other than portions thereof related to price and other confidential matters), if any.

ARTICLE 5 – BIDDER'S REPRESENTATIONS

5.01 It is the responsibility of each Bidder before submitting a Bid to:

- A. examine and carefully study the Bidding Documents, and any data and reference items identified in the Bidding Documents;
- B. visit the Site, conduct a thorough, alert visual examination of the Site and adjacent areas, and become familiar with and satisfy itself as to the general, local, and Site conditions that may affect cost, progress, and performance of the Work;
- C. become familiar with and satisfy itself as to all Laws and Regulations that may affect cost, progress, and performance of the Work, including but not limited to American Iron and Steel requirements as mandated and subsequent statutes mandating domestic preference which apply to the following products made primarily of iron or steel: lined or unlined pipes and fittings, manhole covers and other municipal castings, hydrants, tanks, flanges, pipe clamps and restraints, valves, structural steel, reinforced precast concrete, and construction materials;
- D. carefully study all: (1) reports of explorations and tests of subsurface conditions at or adjacent to the Site and all drawings of physical conditions relating to existing surface or subsurface structures at the Site that have been identified in the Supplementary Conditions, especially with respect to Technical Data in such reports and drawings, and (2) reports and drawings relating to Hazardous Environmental Conditions, if any, at or adjacent to the Site that have

been identified in the Supplementary Conditions, especially with respect to Technical Data in such reports and drawings;

- E. consider the information known to Bidder itself; information commonly known to contractors doing business in the locality of the Site; information and observations obtained from visits to the Site; the Bidding Documents; and the Site-related reports and drawings identified in the Bidding Documents, with respect to the effect of such information, observations, and documents on (1) the cost, progress, and performance of the Work; (2) the means, methods, techniques, sequences, and procedures of construction to be employed by Bidder; and (3) Bidder's safety precautions and programs;
- F. agree, based on the information and observations referred to in the preceding paragraph, that at the time of submitting its Bid no further examinations, investigations, explorations, tests, studies, or data are necessary for the determination of its Bid for performance of the Work at the price bid and within the times required, and in accordance with the other terms and conditions of the Bidding Documents;
- G. become aware of the general nature of the work to be performed by Owner and others at the Site that relates to the Work as indicated in the Bidding Documents;
- H. promptly give Engineer written notice of all conflicts, errors, ambiguities, or discrepancies that Bidder discovers in the Bidding Documents and confirm that the written resolution thereof by Engineer is acceptable to Bidder;
- I. determine that the Bidding Documents are generally sufficient to indicate and convey understanding of all terms and conditions for the performance and furnishing of the Work; and
- J. agree that the submission of a Bid will constitute an incontrovertible representation by Bidder that Bidder has complied with every requirement of this Article, that without exception the Bid and all prices in the Bid are premised upon performing and furnishing the Work required by the Bidding Documents.

ARTICLE 6 – PRE-BID CONFERENCE

6.01 If warranted, a pre-Bid conference will be held at the time and location stated in the invitation or advertisement for bids. Representatives of Owner and Engineer will be present to discuss the Project. Bidders are encouraged to attend and participate in the conference. Engineer will transmit to all prospective Bidders of record such Addenda as Engineer considers necessary in response to questions arising at the conference. Oral statements may not be relied upon and will not be binding or legally effective.

ARTICLE 7 - INTERPRETATIONS AND ADDENDA

7.01 All questions about the meaning or intent of the Bidding Documents are to be submitted to Engineer in writing. Interpretations or clarifications considered necessary by Engineer in response to such questions will be issued by Addenda delivered to all parties recorded as having received the Bidding Documents. Questions received less than seven days prior to the date for opening of Bids may not be answered. Only questions answered by Addenda will be binding. Oral and other interpretations or clarifications will be without legal effect.

7.02 Addenda may be issued to clarify, correct, supplement, or change the Bidding Documents. Addenda will be mailed no later than **three days** prior to the day set for receiving Bids. Failure of any Bidder to receive any such Addendum or interpretation shall not relieve such Bidder from any obligations under the Bid as submitted. All Addenda so issued shall become part of the Contract Documents.

7.03 Addenda may also be issued to clarify, correct, or change the Bidding Documents as deemed advisable by OWNER or ENGINEER.

7.04 Receipt of all addenda must be acknowledged in space provided in the Bid.

ARTICLE 8 - BID SECURITY

8.01 A Bid must be accompanied by Bid security made payable to OWNER in an amount of **five percent (5%)** of the Bidder's maximum Bid price and in the form of a certified check or a Bid Bond (EJCDC No. C-430, 2013 Edition) issued by a surety meeting the requirements of paragraphs 6.01 and 6.02 of the General Conditions.

8.02 The Bid security of the apparent Successful Bidder will be retained until Owner awards the contract to such Bidder, and such Bidder has executed the Contract Documents, furnished the required contract security, and met the other conditions of the Notice of Award, whereupon the Bid security will be released. If the Successful Bidder fails to execute and deliver the Contract Documents and furnish the required contract security within 10 days after the Notice of Award, Owner may consider Bidder to be in default, annul the Notice of Award, and the Bid security of that Bidder will be forfeited. Such forfeiture shall be Owner's exclusive remedy if Bidder defaults.

8.03 The Bid security of other Bidders that Owner believes to have a reasonable chance of receiving the award may be retained by Owner until the earlier of seven days after the Effective Date of the Contract or 91 days after the Bid opening, whereupon Bid security furnished by such Bidders will be released.

8.04 Bid security of other Bidders that Owner believes do not have a reasonable chance of receiving the award will be released within seven days after the Bid opening.

ARTICLE 9 - CONTRACT TIMES

9.01 The number of days within which, or the dates by which the Work is to be substantially completed, and completed and ready for final payment, are set forth in the Agreement.

ARTICLE 10 - LIQUIDATED DAMAGES

10.01 Provisions for liquidated damages, if any, for failure to timely attain Substantial Completion or completion of the Work in readiness for final payment, are set forth in the Agreement.

ARTICLE 11 - SUBSTITUTE OR "OR-EQUAL" ITEMS

11.01 The Contract for the Work, if awarded, will be on the basis of materials and equipment specified or described in the Bidding Documents, and those "or-equal" or substitute or materials and equipment subsequently approved by Engineer prior to the submittal of Bids and identified by Addendum. No item of material or equipment will be considered by Engineer as an "or-equal" or substitute unless written request for approval has been submitted by Bidder and has been received by Engineer at least 15 days prior to the date for receipt of Bids in the case of a proposed substitute and 5 days prior in the case of a proposed "or equal". Each such request shall comply with the requirements of Paragraphs 7.04 and 7.05 of the General Conditions. Each such request shall include Manufacturer's Certification letter for compliance with AIS requirements and subsequent statutes mandating domestic preference, if applicable. Refer to Manufacturer's Certification Letter provided in these Contract Documents.

11.02 All prices that Bidder sets forth in its Bid shall be based on the presumption that the Contractor will furnish the materials and equipment specified or described in the Bidding Documents, as

supplemented by Addenda. Any assumptions regarding the possibility of post-Bid approvals of “or-equal” or substitution requests are made at Bidder’s sole risk.

11.03 If award is made, Contractor shall be allowed to submit proposed substitutes and “or equals” in accordance with the General Conditions.

ARTICLE 12 - SUBCONTRACTORS, SUPPLIERS, AND OTHERS

12.01 A list of subcontractors, suppliers, individuals, or entities shall be submitted along with the Bid at the Bid Opening to the OWNER.

If requested by Owner, such list shall be accompanied by an experience statement with pertinent information regarding similar projects and other evidence of qualification for each such Subcontractor, Supplier, or other individual or entity. If Owner or Engineer, after due investigation, has reasonable objection to any proposed Subcontractor, Supplier, individual, or entity, Owner may, before the Notice of Award is given, request apparent Successful Bidder to submit an acceptable substitute, in which case apparent Successful Bidder shall submit a substitute, Bidder’s Bid price will be increased (or decreased) by the difference in cost occasioned by such substitution, and Owner may consider such price adjustment in evaluating Bids and making the Contract award.

12.02 If apparent Successful Bidder declines to make any such substitution, Owner may award the Contract to the next lowest Bidder that proposes to use acceptable Subcontractors, Suppliers, or other individuals or entities. Declining to make requested substitutions will constitute grounds for forfeiture of the Bid security of any Bidder. Any Subcontractor, Supplier, individual, or entity so listed and against which Owner or Engineer makes no written objection prior to the giving of the Notice of Award will be deemed acceptable to Owner and Engineer subject to subsequent revocation of such acceptance as provided in Paragraph 7.06 of the General Conditions.

12.03 CONTRACTOR shall not be required to employ any subcontractor, supplier, individual, or entity against whom CONTRACTOR has reasonable objection.

12.04 The CONTRACTOR shall not award work to Subcontractor(s) in excess of the limits stated in SC 7.06.

ARTICLE 13 – PREPARATION OF BID

13.01 The Bid Form is included with the Bidding Documents.

- A. All blanks on the Bid form must be typed or completed in ink and the Bid Form signed in ink. Erasures or alterations shall be initialed in ink by the person signing the Bid Form. A Bid price shall be indicated for each section, Bid item, alternative, adjustment unit price item, and unit price item listed therein.
- B. If the Bid Form expressly indicates that submitting pricing on a specific alternate item is optional, and Bidder elects to not furnish pricing for such optional alternate item, then Bidder may enter the words “No Bid” or “Not Applicable.”

13.02 A Bid by a corporation shall be executed in the corporate name by a corporate officer (whose title must appear under the signature), accompanied by evidence of authority to sign. The corporate address and state of incorporation shall be shown. The corporate seal shall be affixed and attested by the secretary or an assistant secretary.

13.03 A Bid by a partnership shall be executed in the partnership name and signed by a partner (whose title must appear under the signature), accompanied by evidence of authority to sign. The official address of the partnership shall be shown below the signature.

13.04 A Bid by a limited liability company shall be executed in the name of the firm by a member and accompanied by evidence of authority to sign. The state of formation of the firm and the official address of the firm shall be shown below the signature.

13.05 A Bid by an individual shall show the Bidder's name and address for receiving notices.

13.06 A Bid by a joint venture shall be executed by each joint venturer in the manner indicated on the Bid form. The joint venture's address for receiving notices shall be shown.

13.07 All names shall be typed or printed in ink below the signatures.

13.08 The Bid shall contain an acknowledgment of receipt of all Addenda, the number and dates of which must be filled in on the Bid form.

13.09 Postal and e-mail addresses and telephone number for communications regarding the Bid shall be shown.

13.10 The Bid shall contain evidence of Bidder's authority and qualification to do business in the state where the Project is located, or Bidder shall covenant in writing to obtain such authority and qualification prior to award of the Contract and attach such covenant to the Bid. Bidder's state contractor license number, if any, shall also be shown on the Bid Form.

ARTICLE 14 - BASIS OF BID; COMPARISON OF BIDS

14.01 Bidders shall submit a Bid on a unit price basis for each item of Work listed in the unit price section of the Bid Form.

14.02 The "Bid Price" (sometimes referred to as the extended price) for each unit price Bid item will be the product of the "Estimated Quantity" (which Owner or its representative has set forth in the Bid Form) for the item and the corresponding "Bid Unit Price" offered by the Bidder. The total of all unit price Bid items will be the sum of these "Bid Prices"; such total will be used by Owner for Bid comparison purposes. The final quantities and Contract Price will be determined in accordance with Paragraph 13.03 of the General Conditions.

14.03 Discrepancies between the multiplication of units of Work and unit prices will be resolved in favor of the unit prices. Discrepancies between the indicated sum of any column of figures and the correct sum thereof will be resolved in favor of the correct sum.

ARTICLE 15 - SUBMITTAL OF BID

15.01 Bid Form is to be completed and submitted with all the attachments as required.

15.02 A Bid shall be received no later than the date and time prescribed and at the place indicated in the advertisement or invitation to bid and shall be enclosed in a plainly marked package with the Project title (and, if applicable, the designated portion of the Project for which the Bid is submitted), the name and address of Bidder, and shall be accompanied by the Bid security and other required documents. If a Bid is sent by mail or other delivery system, the sealed envelope containing the Bid shall be enclosed in a separate package plainly marked on the outside with the notation "BID ENCLOSED." A mailed Bid shall be addressed to the location of the bid opening, as listed in the Advertisement.

15.03 Bids received after the date and time prescribed for the opening of bids, or not submitted at the correct location or in the designated manner, will not be accepted and will be returned to the Bidder unopened.

ARTICLE 16 - MODIFICATION AND WITHDRAWAL OF BIDS

16.01 A Bid may be modified or withdrawn by an appropriate document duly executed in the manner that a Bid must be executed and delivered to the place where Bids are to be submitted prior to the date and time for the opening of Bids. Upon receipt of such notice, the unopened Bid will be returned to the Bidder.

16.02 If a Bidder wishes to modify its Bid prior to Bid opening, Bidder must withdraw its initial Bid in the manner specified in Paragraph 16.01 and submit a new Bid prior to the date and time for the opening of Bids.

16.03 If within 24 hours after Bids are opened any Bidder files a duly signed written notice with Owner and promptly thereafter demonstrates to the reasonable satisfaction of Owner that there was a material and substantial mistake in the preparation of its Bid, that Bidder may withdraw its Bid, and the Bid security will be returned. Thereafter, if the Work is rebid, that Bidder will be disqualified from further bidding on the Work.

ARTICLE 17 - OPENING OF BIDS

17.01 Bids will be opened at the time and place indicated in the advertisement or invitation to bid and, unless obviously non-responsive, read aloud publicly. An abstract of the amounts of the base Bids and major alternates, if any, will be made available to Bidders after the opening of Bids.

ARTICLE 18 - BIDS TO REMAIN SUBJECT TO ACCEPTANCE

18.01 All Bids will remain subject to acceptance for a period of **90 days**, but OWNER may, in its sole discretion, release any Bid and return the Bid security prior to the end of this period.

ARTICLE 19 – EVALUATION OF BIDS & AWARD OF CONTRACT

19.01 Owner reserves the right to reject any or all Bids, including without limitation, nonconforming, nonresponsive, unbalanced, or conditional Bids. Owner will reject the Bid of any Bidder that Owner finds, after reasonable inquiry and evaluation, to not be responsible. If Bidder purports to add terms or conditions to its Bid, takes exception to any provision of the Bidding Documents, or attempts to alter the contents of the Contract Documents for purposes of the Bid, then the Owner will reject the Bid as nonresponsive; provided that Owner also reserves the right to waive all minor informalities not involving price, time, or changes in the Work.

19.02 If Owner awards the contract for the Work, such award shall be to the responsible Bidder submitting the responsive Bid perceived by the Owner as offering the greatest advantage to the Owner.

19.03 Evaluation of Bids

- A. In evaluating Bids, OWNER will consider whether or not the Bids comply with the prescribed requirements, and such alternatives, unit prices, and other data as may be requested in the Bid form or prior to the Notice of Award.
- B. For the determination of the apparent low Bidder(s) when unit price bids are submitted, Bids will be compared on the basis of the total of the products of the estimated quantity of each item and unit price Bid for that item, together with any lump sum items.
- C. In deciding to award a construction contract, the Owner will consider a life-cycle cost analysis performed by the Engineer evaluating the bid prices for the two bidding options, and the total

estimated operational, maintenance and replacement costs over the anticipated service life of the materials.

19.04 In evaluating whether a Bidder is responsible, Owner will consider the qualifications of the Bidder and may consider the qualifications and experience of Subcontractors and Suppliers proposed for those portions of the Work for which the identity of Subcontractors and Suppliers must be submitted as provided in the Bidding Documents.

19.05 Owner may conduct such investigations as Owner deems necessary to establish the responsibility, qualifications, and financial ability of Bidders and any proposed Subcontractors or Suppliers.

19.06 The Bid is subject to Kentucky Revised Statutes Section 45A.490 through 45A.494, which in general provides that a "resident bidder" of Kentucky is to be given a bidding preference over a "nonresident bidder" who is registered in a state that gives preference to its in-state resident bidders over a Kentucky resident bidder. The bidding preference is to be the same as that stipulated of the state of the "nonresident bidder." If the state of "nonresident bidder" provides no specific preference, then "resident" and "nonresident bidders" are to be treated the same when evaluating Bids.

ARTICLE 20 - BONDS AND INSURANCE

20.01 Article 6 of the General Conditions, as may be modified by the Supplementary Conditions, sets forth OWNER's requirements as to performance and payment bonds and insurances. When the Successful Bidder delivers the executed Agreement to OWNER, it must be accompanied by the required performance and payment bonds and insurances.

20.02 All bonds required by the project shall be payable to the OWNER in an amount of one hundred percent of the Contractor's maximum Base Bid price less the value of materials purchased directly by OWNER/COMMISSION.

ARTICLE 21 - SIGNING OF AGREEMENT

21.01 When the OWNER gives a Notice of Award to the Successful Bidder, it will be accompanied by a list of items and information required of the Successful Bidder for evaluation by the OWNER and funding agency, if applicable. Within **10** days thereafter, the successful Bidder shall deliver the full number of original copies of the items listed and the Notice must be acknowledged by the Successful Bidder within **10** days thereafter. After receipt of an acknowledged Notice of Award, a pre-construction meeting will be scheduled at which time the OWNER and Successful Bidder will execute the required number of Agreements and Notice to Proceed. After certification by the Local Counsel and any other required parties, the OWNER shall deliver one fully signed counterpart to the Successful Bidder along with a complete set of Drawings with appropriate identification. OWNER will furnish the Contractor up to three (3) sets of conforming Contract Documents, Technical Specifications and Plans free of charge. Additional sets may be obtained from the Engineer at commercial reproduction rates. The successful bidder shall commence work within ten (10) calendar days after receipt of written notice to proceed and shall progress therewith so that the work shall be completed in accordance with the terms of the Contract Documents within the time allowed after the date of the commencement of contract time.

21.02 This Contract is expected to be funded in part with funds provided by the Delta Regional Authority and the United States Department of Agriculture, Rural Utilities Service (RUS). RUS requirements will apply to the Project.

21.03 Concurrence by RUS in the award of the Contract is required before the Contract is effective.

ARTICLE 22 - RETAINAGE

22.01 Prior to Substantial Completion, OWNER will retain an amount equal to 5% of each progress payment application. Amounts previously retained shall not be paid to the CONTRACTOR until substantial completion of the Work. In no event shall the total Retainage be more than 5% of the value of the work satisfactorily completed.

22.02 Retainage shall be applicable to the Total Value of Work and Stored Materials less the Value of In-place OWNER Purchased Materials.

ARTICLE 23 – LICENSES, FEES, AND TAXES

23.01 The Bid shall include all taxes in effect at the time the Bid is submitted, unless specifically exempted in the Bidding Documents. No change will be allowed for taxes from which OWNER is exempt. Bidders who are uncertain as to what items are subject to tax, or who require further explanation or clarification, are requested to contact the State of Kentucky Revenue Cabinet.

23.02 Successful Bidder must comply with any City ordinances relating to Occupational License Fees, Business Licenses, payroll, and net profits taxes and any other ordinances which may apply to the project. Refer to the Supplementary Conditions SC-6.10 for additional information.

23.03 Successful Bidder must provide proof of having all such licenses or fees at or before the signing of the Contract.

ARTICLE 24 - WAGE RATE DETERMINATION

24.01 If the contract price is in excess of \$100,000, provisions of the Contract Work Hours and Safety Standards Act at 29 CFR 5.5(b) apply.

24.02 Pursuant to 2017 Kentucky House Bill 3, State prevailing wages do not apply to this Contract.

24.03 Federal Davis Bacon wage rates do not apply to this Contract.

ARTICLE 25 – OTHER BID REQUIREMENTS

25.01 Bidder shall complete the following documents attached to the Bid:

- Statement of Experience
- Certification Regarding Debarment, etc.
- Compliance Statement
- Certification for Contract Grants and Loans

ARTICLE 26 – LAWS, ORDINANCES, AND REGULATIONS

26.01 Bidder must familiarize itself with all laws, ordinances, and regulations by federal, state, city, or other governmental agency, which by reason of being neglected or violated may affect the Work contemplated and must secure and pay the fee required for any permits which may be necessary unless such fees are otherwise indicated to be paid in the Bidding Documents.

26.02 Section 746 of Title VII of the Consolidated Appropriations Act of 2017 (Division A - Agriculture, Rural Development, Food and Drug Administration, and Related Agencies Appropriations Act, 2017) and subsequent statutes mandating domestic preference applies an American Iron and Steel requirement to this project. All iron and steel products used in this project must be produced in the United States. "Iron and steel products" means the following products made primarily of iron or steel: lined or unlined pipes

and fittings, manhole covers and other municipal castings, hydrants, tanks, flanges, pipe clamps and restraints, valves, structural steel, reinforced precast concrete, and construction materials. The deminimis and minor components waiver apply to this contract.

ARTICLE 27 – INSURANCE

27.01 Before execution of Contract by OWNER, the successful Bidder shall furnish OWNER a certificate or certificates issued by or on behalf of insurers or a self-insurance program or group self insurance program, qualified to do business in the Commonwealth of Kentucky under KRS Chapter 304 or KRS Chapter 342, certifying that the successful Bidder complies with the Worker's Compensation laws of Kentucky and is insured or indemnified against public liability claims which may arise out of the performance of the Work under the proposed Contract.

ARTICLE 28 – SAFETY STANDARDS AND ACCIDENT PREVENTION:

28.01 With respect to all work performed under this contract, the contractor shall:

Comply with the safety standards provision of applicable laws, building and construction codes and the "Manual of Accident Prevention in Construction" published by the Associated General Contractors of America, the requirements of the Occupational Safety and Health Act of 1970 (Public Law 91-596), and the requirements of Title 29 of the Code of Federal Regulations, Section 1518 as published in the "federal Register", Volume 36, No. 75, Saturday, April 17, 1971. Exercise every precaution at all times for the prevention of accidents and the protection of persons (including employees) and property. Maintain at his/her office or other well know place at the job site, all articles necessary for giving first aid to the injured, and shall make standing arrangements for the immediate removal to a hospital or a doctor's care of persons (including employees), who may be injured on the job site before the employer has made a standing arrangement for removal of injured persons to a hospital or a doctor's care.

BID BOND

Any singular reference to Bidder, Surety, Owner or other party shall be considered plural where applicable.

BIDDER *(Name and Address)*:

SURETY *(Name, and Address of Principal Place of Business)*:

OWNER *(Name and Address)*:

City of Guthrie
PO Box 125
Guthrie, KY 42234

BID

Bid Due Date:

Description *(Project Name— Include Location)*:

BOND

Bond Number:

Date:

Penal sum

\$

(Words)

(Figures)

Surety and Bidder, intending to be legally bound hereby, subject to the terms set forth below, do each cause this Bid Bond to be duly executed by an authorized officer, agent, or representative.

BIDDER

SURETY

(Seal)

(Seal)

Bidder's Name and Corporate Seal

Surety's Name and Corporate Seal

By:

By:

Signature

Signature (Attach Power of Attorney)

Print Name

Print Name

Title

Title

Attest:

Attest:

Signature

Signature

Title

Title

Note: Addresses are to be used for giving any required notice.

Provide execution by any additional parties, such as joint venturers, if necessary.

1. Bidder and Surety, jointly and severally, bind themselves, their heirs, executors, administrators, successors, and assigns to pay to Owner upon default of Bidder the penal sum set forth on the face of this Bond. Payment of the penal sum is the extent of Bidder's and Surety's liability. Recovery of such penal sum under the terms of this Bond shall be Owner's sole and exclusive remedy upon default of Bidder.
2. Default of Bidder shall occur upon the failure of Bidder to deliver within the time required by the Bidding Documents (or any extension thereof agreed to in writing by Owner) the executed Agreement required by the Bidding Documents and any performance and payment bonds required by the Bidding Documents.
3. This obligation shall be null and void if:
 - 3.1 Owner accepts Bidder's Bid and Bidder delivers within the time required by the Bidding Documents (or any extension thereof agreed to in writing by Owner) the executed Agreement required by the Bidding Documents and any performance and payment bonds required by the Bidding Documents, or
 - 3.2 All Bids are rejected by Owner, or
 - 3.3 Owner fails to issue a Notice of Award to Bidder within the time specified in the Bidding Documents (or any extension thereof agreed to in writing by Bidder and, if applicable, consented to by Surety when required by Paragraph 5 hereof).
4. Payment under this Bond will be due and payable upon default of Bidder and within 30 calendar days after receipt by Bidder and Surety of written notice of default from Owner, which notice will be given with reasonable promptness, identifying this Bond and the Project and including a statement of the amount due.
5. Surety waives notice of any and all defenses based on or arising out of any time extension to issue Notice of Award agreed to in writing by Owner and Bidder, provided that the total time for issuing Notice of Award including extensions shall not in the aggregate exceed 120 days from the Bid due date without Surety's written consent.
6. No suit or action shall be commenced under this Bond prior to 30 calendar days after the notice of default required in Paragraph 4 above is received by Bidder and Surety and in no case later than one year after the Bid due date.
7. Any suit or action under this Bond shall be commenced only in a court of competent jurisdiction located in the state in which the Project is located.
8. Notices required hereunder shall be in writing and sent to Bidder and Surety at their respective addresses shown on the face of this Bond. Such notices may be sent by personal delivery, commercial courier, or by United States Registered or Certified Mail, return receipt requested, postage pre-paid, and shall be deemed to be effective upon receipt by the party concerned.
9. Surety shall cause to be attached to this Bond a current and effective Power of Attorney evidencing the authority of the officer, agent, or representative who executed this Bond on behalf of Surety to execute, seal, and deliver such Bond and bind the Surety thereby.
10. This Bond is intended to conform to all applicable statutory requirements. Any applicable requirement of any applicable statute that has been omitted from this Bond shall be deemed to be included herein as if set forth at length. If any provision of this Bond conflicts with any applicable statute, then the provision of said statute shall govern and the remainder of this Bond that is not in conflict therewith shall continue in full force and effect.
11. The term "Bid" as used herein includes a Bid, offer, or proposal as applicable.

BID FORM

Project Identification: City of Guthrie
Novelis Sanitary Sewer Project: Contract No. 1 – Gravity Sewer

Contract Identification: Contract No. 1 – Gravity Sewer

ARTICLE 1 – BID RECIPIENT

1.01 This Bid is Submitted to: City of Guthrie
PO Box 125
Guthrie, Kentucky 42234

1.02 The undersigned Bidder proposes and agrees, if this Bid is accepted, to enter into an Agreement with Owner in the form included in the Bidding Documents to perform all Work as specified or indicated in the Bidding Documents for the prices and within the times indicated in the Bid and in accordance with the other terms and conditions of the Bidding Documents.

ARTICLE 2 – BIDDER'S ACKNOWLEDGMENTS

2.01 Bidder accepts all of the terms and conditions of the Instructions to Bidders, including without limitation those dealing with the disposition of Bid security. This Bid will remain subject to acceptance for 90 days after the Bid opening, or for such longer period of time that Bidder may agree to in writing upon request of Owner.

ARTICLE 3 – BIDDER'S REPRESENTATIONS

3.01 In submitting this Bid, Bidder represents that:

A. Bidder has examined and carefully studied the Bidding Documents, and any data and reference items identified in the Bidding Documents, and hereby acknowledges receipt of the following Addenda:

| | |
|--------------------|-------------|
| Addendum No. _____ | Dated _____ |
| Addendum No. _____ | Dated _____ |
| Addendum No. _____ | Dated _____ |
| Addendum No. _____ | Dated _____ |

B. Bidder has visited the Site, conducted a thorough, alert visual examination of the Site and adjacent areas, and become familiar with and satisfied itself as to the general, local, and Site conditions that may affect cost, progress, and performance of the Work.

C. Bidder is familiar with and has satisfied itself as to all Laws and Regulations that may affect cost, progress, performance of the Work and including all American Iron and Steel requirements.

D. Bidder has carefully studied all: (1) reports of explorations and tests of subsurface conditions at or adjacent to the Site and all drawings of physical conditions relating to existing surface or subsurface structures at the Site that have been identified in the Supplementary Conditions, especially with respect to Technical Data in such reports and drawings, and (2) reports and drawings relating to Hazardous Environmental Conditions, if any, at or adjacent to the Site that have been identified in the Supplementary Conditions, especially with respect to Technical Data in such reports and drawings.

E. Bidder has considered the information known to Bidder itself; information commonly known to contractors doing business in the locality of the Site; information and observations obtained from visits to the Site; the Bidding Documents; and any Site-related reports and drawings identified in the Bidding Documents, with respect to the effect of such information, observations, and documents on (1) the cost, progress, and performance of the Work; (2) the means, methods, techniques, sequences, and

procedures of construction to be employed by Bidder; and (3) Bidder's safety precautions and programs.

- F. Bidder agrees, based on the information and observations referred to in the preceding paragraph, that no further examinations, investigations, explorations, tests, studies, or data are necessary for the determination of this Bid for performance of the Work at the price bid and within the times required, and in accordance with the other terms and conditions of the Bidding Documents.
- G. Bidder is aware of the general nature of work to be performed by Owner and others at the Site that relates to the Work as indicated in the Bidding Documents.
- H. Bidder has given Engineer written notice of all conflicts, errors, ambiguities, or discrepancies that Bidder has discovered in the Bidding Documents, and confirms that the written resolution thereof by Engineer is acceptable to Bidder.
- I. The Bidding Documents are generally sufficient to indicate and convey understanding of all terms and conditions for the performance and furnishing of the Work.
- J. The submission of this Bid constitutes an incontrovertible representation by Bidder that Bidder has complied with every requirement of this Article, and that without exception the Bid and all prices in the Bid are premised upon performing and furnishing the Work required by the Bidding Documents.

ARTICLE 4 – BIDDER'S CERTIFICATION

4.01 Bidder certifies that:

- A. This Bid is genuine and not made in the interest of or on behalf of any undisclosed individual or entity and is not submitted in conformity with any collusive agreement or rules of any group, association, organization, or corporation;
- B. Bidder has not directly or indirectly induced or solicited any other Bidder to submit a false or sham Bid;
- C. Bidder has not solicited or induced any individual or entity to refrain from bidding; and
- D. Bidder has not engaged in corrupt, fraudulent, collusive, or coercive practices in competing for the Contract. For the purposes of this Paragraph 4.01.D:
 - 1. "corrupt practice" means the offering, giving, receiving, or soliciting of anything of value likely to influence the action of a public official in the bidding process;
 - 2. "fraudulent practice" means an intentional misrepresentation of facts made (a) to influence the bidding process to the detriment of Owner, (b) to establish bid prices at artificial non-competitive levels, or (c) to deprive Owner of the benefits of free and open competition;
 - 3. "collusive practice" means a scheme or arrangement between two or more Bidders, with or without the knowledge of Owner, a purpose of which is to establish bid prices at artificial, non-competitive levels; and
 - 4. "coercive practice" means harming or threatening to harm, directly or indirectly, persons or their property to influence their participation in the bidding process or affect the execution of the Contract.

ARTICLE 5 – BASIS OF BID

5.01 Bidder may bid either of the base bid options, or both. See Instructions to Bidders Article 19 for information on evaluation of bids and award of contract.

5.02 Bidder will compete the Work in accordance with the Contract Documents for the following prices:

| Item No. | Item | Quantity | Units | Unit Price | Total Price |
|----------|---|----------|-------|-------------------------------------|-------------|
| A001 | 12-inch Class 350 DIP Sanitary Sewer, up to 6' in depth, complete & ready for use. <i>{Note pay limits per Spec 02-950, Section 2.0}</i> | 60 | LF | \$ _____ | \$ _____ |
| A002 | 12-inch Class 350 DIP Sanitary Sewer, 6' to 8' in depth, complete & ready for use. <i>{Note pay limits per Spec 02-950, Section 2.0}</i> | 696 | LF | \$ _____ | \$ _____ |
| A003 | 12-inch Class 350 DIP Sanitary Sewer, 8' to 10' in depth, complete & ready for use. <i>{Note pay limits per Spec 02-950, Section 2.0}</i> | 842 | LF | \$ _____ | \$ _____ |
| A004 | 12-inch Class 350 DIP Sanitary Sewer, 10' to 12' in depth, complete & ready for use. <i>{Note pay limits per Spec 02-950, Section 2.0}</i> | 1,019 | LF | \$ _____ | \$ _____ |
| A005 | 12-inch Class 350 DIP Sanitary Sewer, 12' to 14' in depth, complete & ready for use. <i>{Note pay limits per Spec 02-950, Section 2.0}</i> | 510 | LF | \$ _____ | \$ _____ |
| A006 | 12-inch Class 350 DIP Sanitary Sewer, 14' to 16' in depth, complete & ready for use. <i>{Note pay limits per Spec 02-950, Section 2.0}</i> | 100 | LF | \$ _____ | \$ _____ |
| A007 | 12-inch Class 350 DIP Sanitary Sewer, 16' & greater in depth, complete & ready for use. <i>{Note pay limits per Spec 02-950, Section 2.0}</i> | 68 | LF | \$ _____ | \$ _____ |
| A008 | Final Cleanup of affected line route (<u>Exclude Bores & paved areas</u>) in accordance with Spec 02-500, Sect. 3.0 <i>{Note minimum unit price stipulation.}</i> | 3,005 | LF | \$ _____ <i>{\$2.00 Minimum}</i> | \$ _____ |
| A009 | Standard 4' diameter sanitary sewer manhole, 6' to 8' in depth, complete and ready for use | 2 | EA | \$ _____ | \$ _____ |
| A010 | Standard 4' diameter sanitary sewer manhole, 8' to 10' in depth, complete and ready for use | 5 | EA | \$ _____ | \$ _____ |
| A011 | Standard 4' diameter sanitary sewer manhole, 10' to 12' in depth, complete and ready for use | 2 | EA | \$ _____ | \$ _____ |
| A012 | Standard 4' diameter sanitary sewer manhole, 12' to 14' in depth, complete and ready for use | 2 | EA | \$ _____ | \$ _____ |
| A013 | Core into & Connect to Existing sanitary sewer manhole, complete and ready for use. | 1 | EA | \$ _____ | \$ _____ |
| A014 | Steel cased Railroad bore, 24" casing (excluding 12" carrier) in place, complete & ready for use. <i>{In accordance w/ CSX Permit}</i> | 130 | LF | \$ _____ | \$ _____ |

| | | | | | |
|------|---|-----|----|----------|----------|
| A015 | Steel cased Highway bore, 24" casing (excluding 12" carrier) in place, complete & ready for use. {In accordance w/ KYTC Permit} | 160 | LF | \$ _____ | \$ _____ |
| A016 | Wide Stream Crossings of affected pipeline route with 20" steel casing in accordance with KDOW/ACOE Permit and Detail 6, Sheet D-1. | 50 | LF | \$ _____ | \$ _____ |
| A017 | Wetland Crossing & Restoration of affected uncased pipeline route in accordance with ACOE permit and Detail 2, Sheet D-2. | 700 | LF | \$ _____ | \$ _____ |
| A018 | Construction Staking, Layout, and Record Survey & Drawings (in accordance with Spec 01-900) | 1 | LS | \$ _____ | \$ _____ |

TOTAL AMOUNT OF BID

| |
|----------|
| \$ _____ |
|----------|

5.03 Bidder acknowledges that (1) each Bid Unit Price includes an amount considered by Bidder to be adequate to cover Contractor's overhead and profit for each separately identified item, and (2) estimated quantities are not guaranteed, and are solely for the purpose of comparison of Bids, and final payment for all unit price Bid items will be based on actual quantities, determined as provided in the Contract Documents.

5.04 SUPPLEMENTAL UNIT PRICES: The following Supplemental Unit Prices will apply in the event that additions to or deductions from the work required in the Bid are ordered. A single price shall be bid for each item. OWNER reserves the right to accept or reject these prices by inclusion in or omission from the Contract Documents to be executed after the award of the Contract.

| Item # | Item Description | Units | Unit Bid Price |
|--------|--|-------|----------------|
| S1 | Unclassified undercut, where ordered by the Engineer. | CY | \$ _____. |
| S2 | No. 57 aggregate refill, where ordered by the Engineer. | Ton | \$ _____. |
| S3 | Class "B" concrete refill, where ordered by the Engineer. the Engineer | CY | \$ _____. |
| S4 | Polyethylene Wrap of Ductile Iron Pipe, excluding pipe, where ordered by Engineer. | LF | \$ _____. |
| S5 | Miscellaneous Sewer Line Marker installed, where ordered by Engineer | EA | \$ _____. |
| S6 | 4" Schedule 40 service line, in place, complete and ready for use. | LF | \$ _____. |
| S7 | 4" Sewer Service Tap, in place, complete, and ready for use | EA | \$ _____. |

| | | | |
|----|---|----|-----------|
| S8 | 4" PVC clean out, in place, complete, and ready for use | EA | \$ _____. |
|----|---|----|-----------|

5.05 MATERIALS PURCHASED DIRECTLY BY OWNER: Provide bid pricing for materials to be purchased directly by the Owner (reference Specification Section 01-210). Contractor has included in the unit bid prices for the work under part 5.02, the following material costs.

| Bid Item # | Material Item | Vendor | Units | Unit Price |
|-------------|-------------------------------------|--------|-------|------------|
| A001-A007 | 12-inch Class 350 Ductile Iron Pipe | | LF | \$ _____ |
| A014 - A016 | 24-inch Steel Casing Pipe | | LF | \$ _____ |

ARTICLE 6 – TIME OF COMPLETION

6.01 Bidder agrees that the Work will be substantially complete and will be completed and ready for final payment in accordance with Paragraph 15.06 of the General Conditions on or before the dates or within the number of calendar days indicated in the Agreement.

6.02 Bidder accepts the provisions of the Agreement as to liquidated damages.

ARTICLE 7 – ATTACHMENTS TO THIS BID

7.01 The following documents are attached to and made a condition of the Bid:

- A. Required Bid security in the form of a Bid Bond (EJCDC No. C-430) or Certified Check (circle type of security provided);
- B. If Bid amount exceeds \$10,000, signed Compliance Statement (RD 400-6). Refer to specific equal opportunity requirements set forth in the Supplemental General Conditions;
- C. If Bid amount exceeds \$25,000, signed Certification Regarding Debarment, Suspension, Ineligibility and Voluntary Exclusion - Lower Tier Covered Transactions (AD-1048);
- D. If Bid amount exceeds \$100,000, signed RD Instruction 1940-Q, Exhibit A-1, Certification for Contracts, Grants, and Loans;
- E. Manufacturers' Certification letter (See Appendix) on any approved "or equal" or substitute request to ensure compliance with AIS requirements and any subsequent statues mandating domestic preference.
- F. Statement of Experience

ARTICLE 8 – DEFINED TERMS

8.01 The terms used in this Bid with the initial capital letters have the meanings indicated in the Instructions to Bidders, the General Conditions, and the Supplementary Conditions.

ARTICLE 9 – BID SUBMITTAL

9.01 This Bid submitted by:

Submitted by:

| | |
|---------------------------------|---|
| _____ Signature | _____ Business |
| _____ Printed or Typed Name | _____ Bidder's Business Address |
| _____ Title | _____ City, State, Zip Code |
| _____ Employer's Tax ID No. | _____ Business Phone No. Business Fax No. |
| _____ Business Email Address | _____ Cell Phone No. Other Contact No. |

9.02 Bid submitted on _____, 2018.

Seal below (if required)

STATEMENT OF EXPERIENCE

The following list represents the most recent clients for whom similar work was performed by the BIDDER. The persons listed may be contacted as references. Provide at least four unique and non-Owner related project references.

| No. | Contact Person, Company & Phone No. | Project Description, Date & Approximate Value of Work |
|-----|-------------------------------------|---|
| 1. | <hr/> <hr/> <hr/> | <hr/> <hr/> <hr/> |
| 2. | <hr/> <hr/> <hr/> | <hr/> <hr/> <hr/> |
| 3. | <hr/> <hr/> <hr/> | <hr/> <hr/> <hr/> |
| 4. | <hr/> <hr/> <hr/> | <hr/> <hr/> <hr/> |
| 5. | <hr/> <hr/> <hr/> | <hr/> <hr/> <hr/> |
| 6. | <hr/> <hr/> <hr/> | <hr/> <hr/> <hr/> |

Bidder

CERTIFICATION FOR CONTRACTS, GRANTS AND LOANS

The undersigned certifies, to the best of his or her knowledge and belief, that:

1. No Federal appropriated funds have been paid or will be paid, by or on behalf of the undersigned, to any person for influencing or attempting to influence an officer or employee of any agency, a Member of Congress, an officer or employee of Congress, or an employee of a Member of Congress in connection with the awarding of any Federal contract, the making of any Federal grant or Federal loan, and the extension, continuation, renewal, amendment, or modification of any Federal contract, grant or loan.

2. If any funds other than Federal appropriated funds have been paid or will be paid to any person for influencing or attempting to influence an officer or employee of any agency, a Member of Congress, an officer or employee of Congress, or an employee of a Member of Congress in connection with this Federal contract, grant or loan, the undersigned shall complete and submit Standard Form - LLL, "Disclosure of Lobbying Activities," in accordance with its instructions.

3. The undersigned shall require that the language of this certification be included in the award documents for all subawards at all tiers (including contracts, subcontracts, and subgrants under grants and loans) and that all subrecipients shall certify and disclose accordingly.

This certification is a material representation of fact upon which reliance was placed when this transaction was made or entered into. Submission of this certification is a prerequisite for making or entering into this transaction imposed by section 1352, title 31, U.S. Code. Any person who fails to file the required certification shall be subject to a civil penalty of not less than \$10,000 and not more than \$100,000 for each such failure.

(name)

(date)

(title)

oOo

U.S. DEPARTMENT OF AGRICULTURE

CERTIFICATION REGARDING DEBARMENT, SUSPENSION, INELIGIBILITY AND VOLUNTARY EXCLUSION - LOWER TIER COVERED TRANSACTIONS

This certification is required by the regulations implementing Executive Order 12549, Debarment and Suspension, 7 CFR Part 3017, Section 3017.510, Participants' responsibilities. The regulations were published as Part IV of the January 30, 1989, Federal Register (pages 4722-4733). Copies of the regulations may be obtained by contacting the Department of Agriculture agency with which this transaction originated.

(BEFORE COMPLETING CERTIFICATION, READ INSTRUCTIONS ON REVERSE)

- (1) The prospective lower tier participant certifies, by submission of this proposal, that neither it nor its principals is presently debarred, suspended, proposed for debarment, declared ineligible, or voluntarily excluded from participation in this transaction by any Federal department or agency.
- (2) Where the prospective lower tier participant is unable to certify to any of the statements in this certification, such prospective participant shall attach an explanation to this proposal.

Organization Name

PR/Award Number or Project Name

Name(s) and Title(s) of Authorized Representative(s)

Signature(s)

Date

Instructions for Certification

1. By signing and submitting this form, the prospective lower tier participant is providing the certification set out on the reverse side in accordance with these instructions.
2. The certification in this clause is a material representation of fact upon which reliance was placed when this transaction was entered into. If it is later than determined that the prospective lower tier participant knowingly rendered an erroneous certification, in addition to other remedies available to the Federal Government, the department or agency with which this transaction originated may pursue available remedies, including suspension and/or debarment.
3. The prospective lower tier participant shall provide immediate written notice to the person to which this proposal is submitted if at any time the prospective lower tier participant learns that its certification was erroneous when submitted or has become erroneous by reason of changed circumstances.
4. The terms "covered transactions," "debarred," "suspended," "ineligible," "lower tier covered transactions," "participant," "person," "primary covered transaction," "principal," "proposal," and "voluntarily excluded," as used in this clause, have the meanings set out in the Definitions and Coverage sections of rules implementing Executive Order 12549. You may contact the person to which this proposal is submitted for assistance in obtaining a copy of those regulations.
5. The prospective lower tier participant agrees by submitting this form that, should the proposed covered transaction be entered into, it shall not knowingly enter into any lower tier covered transaction with a person who is debarred, suspended, declared ineligible, or voluntarily excluded from participation in this covered transaction, unless authorized by the department or agency with which this transaction originated.
6. The prospective lower tier participant further agrees by submitting this form that it will include this clause titled "Certification Regarding Debarment, Suspension, Ineligibility and Voluntary Exclusion - Lower Tier Covered Transactions," without modification, in all lower tier covered transactions and in all solicitations for lower tier covered transactions.
7. A participant in a covered transaction may rely upon a certification of a prospective participant in a lower tier covered transaction that it is not debarred, suspended, ineligible, or voluntarily excluded from the covered transaction, unless it knows that the certification is erroneous. A participant may decide the method and frequency by which it determines the eligibility of its principals. Each participant may, but is not required to, check the Nonprocurement List.
8. Nothing contained in the foregoing shall be construed to require establishment of a system of records in order to render in good faith the certification required by this clause. The knowledge and information of a participant is not required to exceed that which is normally possessed by a prudent person in the ordinary course of business dealings.
9. Except for transactions authorized under paragraph 5 of these instructions, if a participant in a covered transaction knowingly enters into a lower tier covered transaction with a person who is suspended, debarred, ineligible, or voluntarily excluded from participation in this transaction, in addition to other remedies available to the Federal Government, the department or agency with which this transaction originated may pursue available remedies, including suspension and/or debarment.

COMPLIANCE STATEMENT

This statement relates to a proposed contract with _____

(Name of borrower or grantee)

who expects to finance the contract with assistance from either the Rural Housing Service (RHS), Rural Business-Cooperative Service (RBS), or the Rural Utilities Service (RUS) or their successor agencies, United States Department of Agriculture (whether by a loan, grant, loan insurance, guarantee, or other form of financial assistance). I am the undersigned bidder or prospective contractor, I represent that:

1. I have, have not, participated in a previous contract or subcontract subject to Executive 11246 (regarding equal employment opportunity) or a preceding similar Executive Order.
2. If I have participated in such a contract or subcontract, I have, have not, filed all compliance reports that have been required to file in connection with the contract or subcontract.

If the proposed contract is for \$50,000 or more and I have 50 or more employees, I also represent that:

3. I have, have not previously had contracts subject to the written affirmative action programs requirements of the Secretary of Labor.
4. If I have participated in such a contract or subcontract, I have, have not developed and placed on file at each establishment affirmative action programs as required by the rules and regulations of the Secretary of Labor.

I understand that if I have failed to file any compliance reports that have been required of me, I am not eligible and will not be eligible to have my bid considered or to enter into the proposed contract unless and until I make an arrangement regarding such reports that is satisfactory to either the RHS, RBS or RUS, or to the office where the reports are required to be filed.

I also certify that I do not maintain or provide for my employees any segregated facilities at any of my establishments, and that I do not permit my employees to perform their services at any location, under my control, where segregated facilities are maintained. I certify further that I will not maintain or provide for my employees any segregated facilities at any of my establishments, and that I will not permit my employees to perform their services at any location, under my control, where segregated facilities are maintained. I agree that a breach of this certification is a violation of the Equal Opportunity clause in my contract. As used in this certification, the term "segregated facilities" means any waiting rooms, work areas, restrooms and wash rooms, restaurants and other eating areas time clocks, locker rooms and other storage or dressing areas, parking lots, drinking fountains, recreation or entertainment areas, transportation, and housing facilities provided for employees which are segregated by explicit directive or are in fact segregated on the basis of race, creed, color, or national origin, because of habit, local custom, or otherwise. I further agree that (except where I have obtained identical certifications for proposed subcontractors for specific time periods) I will obtain identical certifications from proposed subcontractors prior to the award of subcontracts exceeding \$10,000 which are not exempt from the provisions of the Equal Opportunity clause; that I will retain such certifications in my files; and that I will forward the following notice to such proposed subcontractors (except where the proposed subcontractors have submitted identical certifications for specific time periods): (See Reverse).

According to the Paperwork Reduction Act of 1995, an agency may not conduct or sponsor, and a person is not required to respond to a collection of information unless it displays a valid OMB control number. The valid OMB control number for this information collection is 0575-0018. The time required to complete this information collection is estimated to average 10 minutes per response, including the time for reviewing instructions, searching existing data sources, gathering and maintaining the data needed, and completing and reviewing the collection of information.

**NOTICE TO PROSPECTIVE SUBCONTRACTORS OF REQUIREMENTS FOR
CERTIFICATIONS OF NON-SEGREGATED FACILITIES**

A certification of Nonsegregated Facilities, as required by the May 9, 1967, order (32F.R. 7439, May 19, 1967) on Elimination of Segregated Facilities, by the Secretary of Labor, must be submitted prior to the award of a subcontract exceeding \$10,000 which is not exempt from the provisions of the Equal Opportunity clause. The certification may be submitted either for each subcontract or for all subcontracts during a period (i.e. quarterly, semiannually, or annually).

NOTE: The penalty for making false statements in offers is prescribed in 18 U.S.C. 1001.

DATE _____

(Signature of Bidder or Prospective Contractor)

Address (including Zip Code)

NOTICE OF AWARD

TO:

PROJECT Description: **City of Guthrie
Novelis Sanitary Sewer Project
Contract No. 1 – Gravity Sewer**

The OWNER has considered the BID submitted by you for the above-described WORK in response to its Advertisement for Bids dated _____ and Instructions to Bidders.

You are hereby notified that your BID has been accepted for DIP items in the amount of \$ _____

You are required by the Instructions to Bidders to execute the Agreement and furnish the required CONTRACTOR'S Performance BOND, Payment BOND and certificates of insurance within ten (10) calendar days from the date of this Notice to you.

If you fail to execute said Agreement and to furnish said BONDS within ten (10) days from the date of this Notice, said OWNER will be entitled to consider all your rights arising out of the OWNER's acceptance of your BID as abandoned and as a forfeiture of your BID BOND. The OWNER will be entitled to such other rights as may be granted by law.

Within ten (10) days of your compliance of the above conditions, Owner will return to you one fully executed counterpart of the Agreement, together with an additional copies of the Contract Documents as indicated in Paragraph 2.02 of the General Conditions.

You are required to return an acknowledged copy of this NOTICE OF AWARD to the OWNER.

Dated this ____ day of _____.

CITY OF GUTHRIE

A. Scott Marshall, Mayor

ACCEPTANCE OF NOTICE

Receipt of the above NOTICE OF AWARD is hereby acknowledged and dated this ____ day of _____ 2019.

(contractor)

Name

Title

**SUGGESTED FORM OF AGREEMENT
BETWEEN OWNER AND CONTRACTOR
FOR CONSTRUCTION CONTRACT (STIPULATED PRICE)
FUNDING AGENCY EDITION**

THIS AGREEMENT is by and between _____ **City of Guthrie, Kentucky** _____ (“Owner”) and

_____ (“Contractor”).

Owner and Contractor, in consideration of the mutual covenants hereinafter set forth, agree as follows:

ARTICLE 1 – WORK

1.01 Contractor shall complete all Work as specified or indicated in the Contract Documents. The Work is generally described as follows:

The Work involves the installation of nearly 3,300 LF of 12-inch gravity sewer lines plus other appurtenances to serve a new industrial customer on US Highway 79 in Todd County (KY).

ARTICLE 2 – THE PROJECT

2.01 The Project, of which the Work under the Contract Documents is a part, is generally described as follows:

Novelis Sanitary Sewer Project: Contract No. 1 – Gravity Sewer

ARTICLE 3 – ENGINEER

3.01 The part of the Project that pertains to the Work has been designed by **McGhee Engineering Inc.**

3.02 The Owner has retained **McGhee Engineering Inc.** (Engineer) to act as Owner’s representative, assume all duties and responsibilities, and have the rights and authority assigned to Engineer in the Contract Documents in connection with the completion of the Work in accordance with the Contract Documents.

ARTICLE 4 – CONTRACT TIMES

4.01 *Time of the Essence*

A. All time limits for Milestones, if any, Substantial Completion, and completion and readiness for final payment as stated in the Contract Documents are of the essence of the Contract.

4.02 *Contract Times: Days*

A. The Work will be substantially completed within **90** days after the date when the Contract Time commence to run as provided in Paragraph 4.01 of the General Conditions, and completed and ready for final payment in accordance with Paragraph 15.06 of the General Conditions within **90** days after the date when the Contract Times commence to run.

4.03 *Liquidated Damages*

A. Contractor and Owner recognize that time is of the essence as stated in Paragraph 4.01 above and that Owner will suffer financial and other losses if the Work is not completed and Milestones not achieved within the times specified in Paragraph 4.02 above, plus any extensions thereof allowed in accordance with the Contract. The parties

also recognize the delays, expense, and difficulties involved in proving in a legal or arbitration proceeding the actual loss suffered by Owner if the Work is not completed on time. Accordingly, instead of requiring any such proof, Owner and Contractor agree that as liquidated damages for delay (but not as a penalty):

1. Substantial Completion: Contractor shall pay Owner **\$500** for each day that expires after the time (as duly adjusted pursuant to the Contract) specified in Paragraph 4.02.A above for Substantial Completion until the Work is substantially complete.
2. Completion of Remaining Work: After Substantial Completion, if Contractor shall neglect, refuse, or fail to complete the remaining Work within the Contract Times (as duly adjusted pursuant to the Contract) for completion and readiness for final payment, Contractor shall pay Owner **\$500** for each day that expires after such time until the Work is completed and ready for final payment.
3. Liquidated damages for failing to timely attain Substantial Completion and final completion are not additive and will not be imposed concurrently.

ARTICLE 5 – CONTRACT PRICE

5.01 Owner shall pay Contractor for completion of the Work in accordance with the Contract Documents the amounts that follow, subject to adjustment under the Contract:

- A. For all Work, at the prices (*Ductile Iron Option*) stated in Contractor's Bid, attached hereto as an exhibit.

ARTICLE 6 – PAYMENT PROCEDURES

6.01 *Submittal and Processing of Payments*

- A. Contractor shall submit Applications for Payment in accordance with Article 15 of the General Conditions. Applications for Payment will be processed by Engineer as provided in the General Conditions.

6.02 *Progress Payments; Retainage*

- A. Owner shall make progress payments on account of the Contract Price on the basis of Contractor's Applications for Payment on or about the **first** day of each month during performance of the Work as provided in Paragraph 6.02.A.1 below, provided that such Applications for Payment have been submitted in a timely manner and otherwise meet the requirements of the Contract. All such payments will be measured by the Schedule of Values established as provided in the General Conditions (and in the case of Unit Price Work based on the number of units completed) or, in the event there is no Schedule of Values, as provided elsewhere in the Contract.
 1. Prior to Substantial Completion, progress payments will be made in an amount equal to the percentage indicated below but, in each case, less the aggregate of payments previously made and less such amounts as Owner may withhold, including but not limited to liquidated damages, in accordance with the Contract
 - a. 95 percent of Work completed (with the balance being retainage); and
 - b. 95 percent of cost of materials and equipment not incorporated in the Work (with the balance being retainage).
 2. Upon Substantial Completion of the entire construction to be provided under the Contract Documents..

6.03 *Final Payment*

- A. Upon final completion and acceptance of the Work in accordance with Paragraph 15.06 of the General Conditions, Owner shall pay the remainder of the Contract Price as recommended by Engineer as provided in said Paragraph 15.06.

ARTICLE 7 – INTEREST

- 7.01 All amounts not paid when due shall bear interest at the maximum legal rate.

ARTICLE 8 – CONTRACTOR’S REPRESENTATIONS

- 1.02 In order to induce Owner to enter into this Contract, Contractor makes the following representations:

- A. Contractor has examined and carefully studied the Contract Documents, and any data and reference items identified in the Contract Documents.
- B. Contractor has visited the Site, conducted a thorough, alert visual examination of the Site and adjacent areas, and become familiar with and is satisfied as to the general, local, and Site conditions that may affect cost, progress, and performance of the Work.
- C. Contractor is familiar with and is satisfied as to all Laws and Regulations that may affect cost, progress, and performance of the Work.
- D. Contractor has carefully studied all: (1) reports of explorations and tests of subsurface conditions at or adjacent to the Site and all drawings of physical conditions relating to existing surface or subsurface structures at the Site that have been identified in the Supplementary Conditions, especially with respect to Technical Data in such reports and drawings, and (2) reports and drawings relating to Hazardous Environmental Conditions, if any, at or adjacent to the Site that have been identified in the Supplementary Conditions, especially with respect to Technical Data in such reports and drawings.
- E. Contractor has considered the information known to Contractor itself; information commonly known to contractors doing business in the locality of the Site; information and observations obtained from visits to the Site; the Contract Documents; and the Site-related reports and drawings identified in the Contract Documents, with respect to the effect of such information, observations, and documents on (1) the cost, progress, and performance of the Work; (2) the means, methods, techniques, sequences, and procedures of construction to be employed by Contractor; and (3) Contractor’s safety precautions and programs.
- F. Based on the information and observations referred to in the preceding paragraph, Contractor agrees that no further examinations, investigations, explorations, tests, studies, or data are necessary for the performance of the Work at the Contract Price, within the Contract Times, and in accordance with the other terms and conditions of the Contract.
- G. Contractor is aware of the general nature of work to be performed by Owner and others at the Site that relates to the Work as indicated in the Contract Documents.
- H. Contractor has given Engineer written notice of all conflicts, errors, ambiguities, or discrepancies that Contractor has discovered in the Contract Documents, and the written resolution thereof by Engineer is acceptable to Contractor.
- I. The Contract Documents are generally sufficient to indicate and convey understanding of all terms and conditions for performance and furnishing of the Work.

- J. Contractor's entry into this Contract constitutes an incontrovertible representation by Contractor that without exception all prices in the Agreement are premised upon performing and furnishing the Work required by the Contract Documents.

ARTICLE 9 – CONTRACT DOCUMENTS

9.01 Contents

- A. The Contract Documents consist of the following:
1. This Agreement (pages 1 to 6 inclusive).
 2. Performance bond (pages 1 to 3 inclusive).
 3. Payment bond (pages 1 to 3 inclusive).
 4. Bid bonds (pages 1 to 2 inclusive).
 5. General Conditions (pages 1 to 66 inclusive).
 6. Supplementary Conditions (pages 1 to 3 inclusive).
 7. Specifications as listed in the table of contents of the Project Manual.
 8. Drawings consisting of 6 sheets with each sheet bearing the following general title: Novelis Sanitary Sewer Project: Contract No. 1 – Gravity Sewer.
 9. Addenda (numbers * to *, inclusive).
 10. Exhibits to this Agreement (enumerated as follows):
 - a. Contractor's Bid (pages 1 to 6 inclusive).
 - b. Documents submitted by Contractor prior to Notice of Award – List of Subcontractors.
 - c. Documents submitted by Contractor prior to Notice of Award – Statement of Experience.
 11. The following which may be delivered or issued on or after the Effective Date of the Agreement and are not attached hereto:
 - a. Notice to Proceed (pages 1 to 1, inclusive).
 - b. Work Change Directives.
 - c. Change Order(s).
- B. The documents listed in Paragraph 9.01.A are attached to this Agreement (except as expressly noted otherwise above).
- C. There are no Contract Documents other than those listed above in this Article 9.
- D. The Contract Documents may only be amended, modified, or supplemented as provided in the General Conditions.

ARTICLE 10 – MISCELLANEOUS

10.01 *Terms*

- A. Terms used in this Agreement will have the meanings stated in the General Conditions and the Supplementary Conditions.

10.02 *Assignment of Contract*

- A. Unless expressly agreed to elsewhere in the Contract, no assignment by a party hereto of any rights under or interests in the Contract will be binding on another party hereto without the written consent of the party sought to be bound; and, specifically but without limitation, money that may become due and money that is due may not be assigned without such consent (except to the extent that the effect of this restriction may be limited by law), and unless specifically stated to the contrary in any written consent to an assignment, no assignment will release or discharge the assignor from any duty or responsibility under the Contract Documents.

10.03 *Successors and Assigns*

- A. Owner and Contractor each binds itself, its successors, assigns, and legal representatives to the other party hereto, its successors, assigns, and legal representatives in respect to all covenants, agreements, and obligations contained in the Contract Documents.

10.04 *Severability*

- A. Any provision or part of the Contract Documents held to be void or unenforceable under any Law or Regulation shall be deemed stricken, and all remaining provisions shall continue to be valid and binding upon Owner and Contractor, who agree that the Contract Documents shall be reformed to replace such stricken provision or part thereof with a valid and enforceable provision that comes as close as possible to expressing the intention of the stricken provision.

10.05 *Contractor's Certifications*

- A. Contractor certifies that it has not engaged in corrupt, fraudulent, collusive, or coercive practices in competing for or in executing the Contract. For the purposes of this Paragraph 10.05:
 1. “corrupt practice” means the offering, giving, receiving, or soliciting of any thing of value likely to influence the action of a public official in the bidding process or in the Contract execution;
 2. “fraudulent practice” means an intentional misrepresentation of facts made (a) to influence the bidding process or the execution of the Contract to the detriment of Owner, (b) to establish Bid or Contract prices at artificial non-competitive levels, or (c) to deprive Owner of the benefits of free and open competition;
 3. “collusive practice” means a scheme or arrangement between two or more Bidders, with or without the knowledge of Owner, a purpose of which is to establish Bid prices at artificial, non-competitive levels; and
 4. “coercive practice” means harming or threatening to harm, directly or indirectly, persons or their property to influence their participation in the bidding process or affect the execution of the Contract.

10.06 *Other Provisions*

- A. Owner stipulates that if the General Conditions that are made a part of this Contract are based on EJCDC® C-700, Standard General Conditions for the Construction Contract, published by the Engineers Joint Contract Documents Committee®, and if Owner is the party that has furnished said General Conditions, then Owner has plainly shown all modifications to the standard wording of such published document to the Contractor in the Supplementary Conditions.

IN WITNESS WHEREOF, Owner and Contractor have signed this Agreement.

This Agreement will be effective on _____ (which is the Effective Date of the Contract).

OWNER:

CONTRACTOR

City of Guthrie _____

By: _____

By: _____

Title: **A. Scott Marshall, Mayor** _____

Title: _____

[CORPORATE SEAL]

[CORPORATE SEAL]

Attest: _____

Attest: _____

Title: **Allison Austin, City Clerk** _____

Title: _____

Address for giving notices:

Address for giving notices:

PO Box 125 _____

Guthrie, KY 42234 _____

License No. (where applicable): _____

(If Owner is a corporation, attach evidence of authority to sign. If Owner is a public body, attach evidence of authority to sign and resolution or other documents authorizing execution of this Agreement.)

NOTE TO USER: Use in those states or other jurisdictions where applicable or required.

PERFORMANCE BOND

CONTRACTOR *(name and address)*:

SURETY *(name and address of principal place of business)*:

OWNER *(name and address)*:

City of Guthrie
PO Box 125
Guthrie, KY 42234

CONSTRUCTION CONTRACT

Effective Date of the Agreement:

Amount:

Description *(name and location)*:

BOND

Bond Number:

Date *(not earlier than the Effective Date of the Agreement of the Construction Contract)*:

Amount:

Modifications to this Bond Form: None See Paragraph 16

Surety and Contractor, intending to be legally bound hereby, subject to the terms set forth below, do each cause this Performance Bond to be duly executed by an authorized officer, agent, or representative.

CONTRACTOR AS PRINCIPAL

SURETY

Contractor's Name and Corporate Seal *(seal)*

Surety's Name and Corporate Seal *(seal)*

By: _____
Signature

By: _____
Signature *(attach power of attorney)*

Print Name

Print Name

Title

Title

Attest: _____
Signature

Attest: _____
Signature

Title

Title

Notes: (1) Provide supplemental execution by any additional parties, such as joint venturers. (2) Any singular reference to Contractor, Surety, Owner, or other party shall be considered plural where applicable.

1. The Contractor and Surety, jointly and severally, bind themselves, their heirs, executors, administrators, successors, and assigns to the Owner for the performance of the Construction Contract, which is incorporated herein by reference.

2. If the Contractor performs the Construction Contract, the Surety and the Contractor shall have no obligation under this Bond, except when applicable to participate in a conference as provided in Paragraph 3.

3. If there is no Owner Default under the Construction Contract, the Surety's obligation under this Bond shall arise after:

3.1 The Owner first provides notice to the Contractor and the Surety that the Owner is considering declaring a Contractor Default. Such notice shall indicate whether the Owner is requesting a conference among the Owner, Contractor, and Surety to discuss the Contractor's performance. If the Owner does not request a conference, the Surety may, within five (5) business days after receipt of the Owner's notice, request such a conference. If the Surety timely requests a conference, the Owner shall attend. Unless the Owner agrees otherwise, any conference requested under this Paragraph 3.1 shall be held within ten (10) business days of the Surety's receipt of the Owner's notice. If the Owner, the Contractor, and the Surety agree, the Contractor shall be allowed a reasonable time to perform the Construction Contract, but such an agreement shall not waive the Owner's right, if any, subsequently to declare a Contractor Default;

3.2 The Owner declares a Contractor Default, terminates the Construction Contract and notifies the Surety; and

3.3 The Owner has agreed to pay the Balance of the Contract Price in accordance with the terms of the Construction Contract to the Surety or to a contractor selected to perform the Construction Contract.

4. Failure on the part of the Owner to comply with the notice requirement in Paragraph 3.1 shall not constitute a failure to comply with a condition precedent to the Surety's obligations, or release the Surety from its obligations, except to the extent the Surety demonstrates actual prejudice.

5. When the Owner has satisfied the conditions of Paragraph 3, the Surety shall promptly and at the Surety's expense take one of the following actions:

5.1 Arrange for the Contractor, with the consent of the Owner, to perform and complete the Construction Contract;

5.2 Undertake to perform and complete the Construction Contract itself, through its agents or independent contractors;

5.3 Obtain bids or negotiated proposals from qualified contractors acceptable to the Owner for a contract for performance and completion of the Construction Contract, arrange for a contract to be prepared for execution by the

Owner and a contractor selected with the Owners concurrence, to be secured with performance and payment bonds executed by a qualified surety equivalent to the bonds issued on the Construction Contract, and pay to the Owner the amount of damages as described in Paragraph 7 in excess of the Balance of the Contract Price incurred by the Owner as a result of the Contractor Default; or

5.4 Waive its right to perform and complete, arrange for completion, or obtain a new contractor, and with reasonable promptness under the circumstances:

5.4.1 After investigation, determine the amount for which it may be liable to the Owner and, as soon as practicable after the amount is determined, make payment to the Owner; or

5.4.2 Deny liability in whole or in part and notify the Owner, citing the reasons for denial.

6. If the Surety does not proceed as provided in Paragraph 5 with reasonable promptness, the Surety shall be deemed to be in default on this Bond seven days after receipt of an additional written notice from the Owner to the Surety demanding that the Surety perform its obligations under this Bond, and the Owner shall be entitled to enforce any remedy available to the Owner. If the Surety proceeds as provided in Paragraph 5.4, and the Owner refuses the payment or the Surety has denied liability, in whole or in part, without further notice the Owner shall be entitled to enforce any remedy available to the Owner.

7. If the Surety elects to act under Paragraph 5.1, 5.2, or 5.3, then the responsibilities of the Surety to the Owner shall not be greater than those of the Contractor under the Construction Contract, and the responsibilities of the Owner to the Surety shall not be greater than those of the Owner under the Construction Contract. Subject to the commitment by the Owner to pay the Balance of the Contract Price, the Surety is obligated, without duplication for:

7.1 the responsibilities of the Contractor for correction of defective work and completion of the Construction Contract;

7.2 additional legal, design professional, and delay costs resulting from the Contractor's Default, and resulting from the actions or failure to act of the Surety under Paragraph 5; and

7.3 liquidated damages, or if no liquidated damages are specified in the Construction Contract, actual damages caused by delayed performance or non-performance of the Contractor.

8. If the Surety elects to act under Paragraph 5.1, 5.3, or 5.4, the Surety's liability is limited to the amount of this Bond.

9. The Surety shall not be liable to the Owner or others for obligations of the Contractor that are unrelated to the Construction Contract, and the Balance of the Contract Price shall not be reduced or set off on account of any such unrelated obligations. No right of action shall accrue on this Bond to any person or entity other than

the Owner or its heirs, executors, administrators, successors, and assigns.

10. The Surety hereby waives notice of any change, including changes of time, to the Construction Contract or to related subcontracts, purchase orders, and other obligations.

11. Any proceeding, legal or equitable, under this Bond may be instituted in any court of competent jurisdiction in the location in which the work or part of the work is located and shall be instituted within two years after a declaration of Contractor Default or within two years after the Contractor ceased working or within two years after the Surety refuses or fails to perform its obligations under this Bond, whichever occurs first. If the provisions of this paragraph are void or prohibited by law, the minimum periods of limitations available to sureties as a defense in the jurisdiction of the suit shall be applicable.

12. Notice to the Surety, the Owner, or the Contractor shall be mailed or delivered to the address shown on the page on which their signature appears.

13. When this Bond has been furnished to comply with a statutory or other legal requirement in the location where the construction was to be performed, any provision in this Bond conflicting with said statutory or legal requirement shall be deemed deleted herefrom and provisions conforming to such statutory or other legal requirement shall be deemed incorporated herein. When so furnished, the intent is that this Bond shall be construed as a statutory bond and not as a common law bond.

14. Definitions

14.1 Balance of the Contract Price: The total amount payable by the Owner to the Contractor under the Construction Contract after all proper adjustments have been made including

allowance for the Contractor for any amounts received or to be received by the Owner in settlement of insurance or other claims for damages to which the Contractor is entitled, reduced by all valid and proper payments made to or on behalf of the Contractor under the Construction Contract.

14.2 Construction Contract: The agreement between the Owner and Contractor identified on the cover page, including all Contract Documents and changes made to the agreement and the Contract Documents.

14.3 Contractor Default: Failure of the Contractor, which has not been remedied or waived, to perform or otherwise to comply with a material term of the Construction Contract.

14.4 Owner Default: Failure of the Owner, which has not been remedied or waived, to pay the Contractor as required under the Construction Contract or to perform and complete or comply with the other material terms of the Construction Contract.

14.5 Contract Documents: All the documents that comprise the agreement between the Owner and Contractor.

15. If this Bond is issued for an agreement between a contractor and subcontractor, the term Contractor in this Bond shall be deemed to be Subcontractor and the term Owner shall be deemed to be Contractor.

16. Modifications to this Bond are as follows:

PAYMENT BOND

CONTRACTOR *(name and address):*

SURETY *(name and address of principal place of business):*

OWNER *(name and address):*

City of Guthrie
PO Box 125
Guthrie, KY 42234

CONSTRUCTION CONTRACT

Effective Date of the Agreement:

Amount:

Description *(name and location):*

BOND

Bond Number:

Date *(not earlier than the Effective Date of the Agreement of the Construction Contract):*

Amount:

Modifications to this Bond Form: None See Paragraph 18

Surety and Contractor, intending to be legally bound hereby, subject to the terms set forth below, do each cause this Payment Bond to be duly executed by an authorized officer, agent, or representative.

CONTRACTOR AS PRINCIPAL

SURETY

(seal)
Contractor's Name and Corporate Seal

(seal)
Surety's Name and Corporate Seal

By: _____
Signature

By: _____
Signature *(attach power of attorney)*

Print Name

Print Name

Title

Title

Attest: _____
Signature

Attest: _____
Signature

Title

Title

Notes: (1) Provide supplemental execution by any additional parties, such as joint venturers. (2) Any singular reference to Contractor, Surety, Owner, or other party shall be considered plural where applicable.

1. The Contractor and Surety, jointly and severally, bind themselves, their heirs, executors, administrators, successors, and assigns to the Owner to pay for labor, materials, and equipment furnished for use in the performance of the Construction Contract, which is incorporated herein by reference, subject to the following terms.
2. If the Contractor promptly makes payment of all sums due to Claimants, and defends, indemnifies, and holds harmless the Owner from claims, demands, liens, or suits by any person or entity seeking payment for labor, materials, or equipment furnished for use in the performance of the Construction Contract, then the Surety and the Contractor shall have no obligation under this Bond.
3. If there is no Owner Default under the Construction Contract, the Surety's obligation to the Owner under this Bond shall arise after the Owner has promptly notified the Contractor and the Surety (at the address described in Paragraph 13) of claims, demands, liens, or suits against the Owner or the Owner's property by any person or entity seeking payment for labor, materials, or equipment furnished for use in the performance of the Construction Contract, and tendered defense of such claims, demands, liens, or suits to the Contractor and the Surety.
4. When the Owner has satisfied the conditions in Paragraph 3, the Surety shall promptly and at the Surety's expense defend, indemnify, and hold harmless the Owner against a duly tendered claim, demand, lien, or suit.
5. The Surety's obligations to a Claimant under this Bond shall arise after the following:
 - 5.1 Claimants who do not have a direct contract with the Contractor,
 - 5.1.1 have furnished a written notice of non-payment to the Contractor, stating with substantial accuracy the amount claimed and the name of the party to whom the materials were, or equipment was, furnished or supplied or for whom the labor was done or performed, within ninety (90) days after having last performed labor or last furnished materials or equipment included in the Claim; and
 - 5.1.2 have sent a Claim to the Surety (at the address described in Paragraph 13).
 - 5.2 Claimants who are employed by or have a direct contract with the Contractor have sent a Claim to the Surety (at the address described in Paragraph 13).
6. If a notice of non-payment required by Paragraph 5.1.1 is given by the Owner to the Contractor, that is sufficient to satisfy a Claimant's obligation to furnish a written notice of non-payment under Paragraph 5.1.1.
7. When a Claimant has satisfied the conditions of Paragraph 5.1 or 5.2, whichever is applicable, the Surety shall promptly and at the Surety's expense take the following actions:
 - 7.1 Send an answer to the Claimant, with a copy to the Owner, within sixty (60) days after receipt of the Claim, stating the amounts that are undisputed and the basis for challenging any amounts that are disputed; and
 - 7.2 Pay or arrange for payment of any undisputed amounts.
 - 7.3 The Surety's failure to discharge its obligations under Paragraph 7.1 or 7.2 shall not be deemed to constitute a waiver of defenses the Surety or Contractor may have or acquire as to a Claim, except as to undisputed amounts for which the Surety and Claimant have reached agreement. If, however, the Surety fails to discharge its obligations under Paragraph 7.1 or 7.2, the Surety shall indemnify the Claimant for the reasonable attorney's fees the Claimant incurs thereafter to recover any sums found to be due and owing to the Claimant.
8. The Surety's total obligation shall not exceed the amount of this Bond, plus the amount of reasonable attorney's fees provided under Paragraph 7.3, and the amount of this Bond shall be credited for any payments made in good faith by the Surety.
9. Amounts owed by the Owner to the Contractor under the Construction Contract shall be used for the performance of the Construction Contract and to satisfy claims, if any, under any construction performance bond. By the Contractor furnishing and the Owner accepting this Bond, they agree that all funds earned by the Contractor in the performance of the Construction Contract are dedicated to satisfy obligations of the Contractor and Surety under this Bond, subject to the Owner's priority to use the funds for the completion of the work.
10. The Surety shall not be liable to the Owner, Claimants, or others for obligations of the Contractor that are unrelated to the Construction Contract. The Owner shall not be liable for the payment of any costs or expenses of any Claimant under this Bond, and shall have under this Bond no obligation to make payments to or give notice on behalf of Claimants, or otherwise have any obligations to Claimants under this Bond.

11. The Surety hereby waives notice of any change, including changes of time, to the Construction Contract or to related subcontracts, purchase orders, and other obligations.
 12. No suit or action shall be commenced by a Claimant under this Bond other than in a court of competent jurisdiction in the state in which the project that is the subject of the Construction Contract is located or after the expiration of one year from the date (1) on which the Claimant sent a Claim to the Surety pursuant to Paragraph 5.1.2 or 5.2, or (2) on which the last labor or service was performed by anyone or the last materials or equipment were furnished by anyone under the Construction Contract, whichever of (1) or (2) first occurs. If the provisions of this paragraph are void or prohibited by law, the minimum period of limitation available to sureties as a defense in the jurisdiction of the suit shall be applicable.
 13. Notice and Claims to the Surety, the Owner, or the Contractor shall be mailed or delivered to the address shown on the page on which their signature appears. Actual receipt of notice or Claims, however accomplished, shall be sufficient compliance as of the date received.
 14. When this Bond has been furnished to comply with a statutory or other legal requirement in the location where the construction was to be performed, any provision in this Bond conflicting with said statutory or legal requirement shall be deemed deleted herefrom and provisions conforming to such statutory or other legal requirement shall be deemed incorporated herein. When so furnished, the intent is that this Bond shall be construed as a statutory bond and not as a common law bond.
 15. Upon requests by any person or entity appearing to be a potential beneficiary of this Bond, the Contractor and Owner shall promptly furnish a copy of this Bond or shall permit a copy to be made.
16. **Definitions**
- 16.1 **Claim:** A written statement by the Claimant including at a minimum:
 1. The name of the Claimant;
 2. The name of the person for whom the labor was done, or materials or equipment furnished;
 3. A copy of the agreement or purchase order pursuant to which labor, materials, or equipment was furnished for use in the performance of the Construction Contract;
 4. A brief description of the labor, materials, or equipment furnished;
 5. The date on which the Claimant last performed labor or last furnished materials or equipment for use in the performance of the Construction Contract;
 - 16.2 **Claimant:** An individual or entity having a direct contract with the Contractor or with a subcontractor of the Contractor to furnish labor, materials, or equipment for use in the performance of the Construction Contract. The term Claimant also includes any individual or entity that has rightfully asserted a claim under an applicable mechanic's lien or similar statute against the real property upon which the Project is located. The intent of this Bond shall be to include without limitation in the terms of "labor, materials, or equipment" that part of the water, gas, power, light, heat, oil, gasoline, telephone service, or rental equipment used in the Construction Contract, architectural and engineering services required for performance of the work of the Contractor and the Contractor's subcontractors, and all other items for which a mechanic's lien may be asserted in the jurisdiction where the labor, materials, or equipment were furnished.
 - 16.3 **Construction Contract:** The agreement between the Owner and Contractor identified on the cover page, including all Contract Documents and all changes made to the agreement and the Contract Documents.
 - 16.4 **Owner Default:** Failure of the Owner, which has not been remedied or waived, to pay the Contractor as required under the Construction Contract or to perform and complete or comply with the other material terms of the Construction Contract.
 - 16.5 **Contract Documents:** All the documents that comprise the agreement between the Owner and Contractor.
17. If this Bond is issued for an agreement between a contractor and subcontractor, the term Contractor in this Bond shall be deemed to be Subcontractor and the term Owner shall be deemed to be Contractor.
 18. Modifications to this Bond are as follows:
6. The total amount earned by the Claimant for labor, materials, or equipment furnished as of the date of the Claim;
 7. The total amount of previous payments received by the Claimant; and
 8. The total amount due and unpaid to the Claimant for labor, materials, or equipment furnished as of the date of the Claim.

NOTICE TO PROCEED

TO: _____

DATE: _____

PROJECT: **City of Guthrie
Novelis Sanitary Sewer Project
Contract No. 1 – Gravity Sewer**

You are hereby notified to commence WORK in accordance with the Agreement dated _____ on or before _____. In accordance with the Agreement, the date of substantial completion is _____, and the number of days needed to achieve readiness for final payment is **90**.

Before starting work at the site, Contractor must comply with the following:
Not applicable.

CITY OF GUTHRIE

A. Scott Marshall, Mayor

ACCEPTANCE OF NOTICE

Receipt of the above NOTICE TO PROCEED is hereby acknowledged and dated this ____ day of _____ 2019.

(contractor)

Name, Title

Employer Identification Number

This document has important legal consequences; consultation with an attorney is encouraged with respect to its use or modification. This document should be adapted to the particular circumstances of the contemplated Project and the controlling Laws and Regulations.

STANDARD GENERAL CONDITIONS OF THE CONSTRUCTION CONTRACT

Prepared by

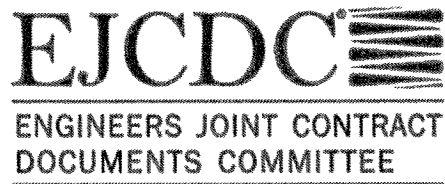

Issued and Published Jointly by



Endorsed by



These General Conditions have been prepared for use with the Agreement Between Owner and Contractor for Construction Contract (EJCDC® C-520, Stipulated Sum, or C-525, Cost-Plus, 2013 Editions). Their provisions are interrelated and a change in one may necessitate a change in the other.

To prepare supplementary conditions that are coordinated with the General Conditions, use EJCDC's Guide to the Preparation of Supplementary Conditions (EJCDC® C-800, 2013 Edition). The full EJCDC Construction series of documents is discussed in the Commentary on the 2013 EJCDC Construction Documents (EJCDC® C-001, 2013 Edition).

Copyright © 2013:

National Society of Professional Engineers
1420 King Street, Alexandria, VA 22314-2794
(703) 684-2882
www.nspe.org

American Council of Engineering Companies
1015 15th Street N.W., Washington, DC 20005
(202) 347-7474
www.acec.org

American Society of Civil Engineers
1801 Alexander Bell Drive, Reston, VA 20191-4400
(800) 548-2723
www.asce.org

The copyright for this document is owned jointly by the three sponsoring organizations listed above. The National Society of Professional Engineers is the Copyright Administrator for the EJCDC documents; please direct all inquiries regarding EJCDC copyrights to NSPE.

NOTE: EJCDC publications may be purchased at www.ejcdc.org, or from any of the sponsoring organizations above

**STANDARD GENERAL CONDITIONS OF THE
CONSTRUCTION CONTRACT**

TABLE OF CONTENTS

| | Page |
|--|-------------|
| ARTICLE 1 – Definitions and Terminology..... | 7 |
| 1.01 Defined Terms..... | 7 |
| 1.02 Terminology | 10 |
| ARTICLE 2 – Preliminary Matters | 11 |
| 2.01 Delivery of Bonds and Evidence of Insurance..... | 11 |
| 2.02 Copies of Documents | 12 |
| 2.03 Before Starting Construction | 12 |
| 2.04 Preconstruction Conference; Designation of Authorized Representatives..... | 12 |
| 2.05 Initial Acceptance of Schedules | 12 |
| 2.06 Electronic Transmittals | 13 |
| ARTICLE 3 – Documents: Intent, Requirements, Reuse..... | 13 |
| 3.01 Intent..... | 13 |
| 3.02 Reference Standards..... | 13 |
| 3.03 Reporting and Resolving Discrepancies | 14 |
| 3.04 Requirements of the Contract Documents..... | 15 |
| 3.05 Reuse of Documents | 15 |
| ARTICLE 4 – Commencement and Progress of the Work | 15 |
| 4.01 Commencement of Contract Times; Notice to Proceed..... | 15 |
| 4.02 Starting the Work..... | 15 |
| 4.03 Reference Points | 16 |
| 4.04 Progress Schedule | 16 |
| 4.05 Delays in Contractor’s Progress | 16 |
| ARTICLE 5 – Availability of Lands; Subsurface and Physical Conditions; Hazardous Environmental Conditions | 17 |
| 5.01 Availability of Lands | 17 |
| 5.02 Use of Site and Other Areas..... | 17 |
| 5.03 Subsurface and Physical Conditions..... | 18 |
| 5.04 Differing Subsurface or Physical Conditions..... | 19 |
| 5.05 Underground Facilities..... | 20 |
| 5.06 Hazardous Environmental Conditions at Site | 21 |

| | |
|---|----|
| ARTICLE 6 – Bonds and Insurance..... | 23 |
| 6.01 Performance, Payment, and Other Bonds..... | 23 |
| 6.02 Insurance—General Provisions..... | 24 |
| 6.03 Contractor’s Insurance..... | 25 |
| 6.04 Owner’s Liability Insurance..... | 27 |
| 6.05 Property Insurance..... | 27 |
| 6.06 Waiver of Rights..... | 29 |
| 6.07 Receipt and Application of Property Insurance Proceeds | 30 |
| ARTICLE 7 – Contractor’s Responsibilities | 30 |
| 7.01 Supervision and Superintendence | 30 |
| 7.02 Labor; Working Hours | 30 |
| 7.03 Services, Materials, and Equipment | 30 |
| 7.04 “Or Equals” | 31 |
| 7.05 Substitutes | 32 |
| 7.06 Concerning Subcontractors, Suppliers, and Others..... | 33 |
| 7.07 Patent Fees and Royalties..... | 34 |
| 7.08 Permits..... | 35 |
| 7.09 Taxes | 35 |
| 7.10 Laws and Regulations..... | 35 |
| 7.11 Record Documents..... | 36 |
| 7.12 Safety and Protection | 36 |
| 7.13 Safety Representative | 37 |
| 7.14 Hazard Communication Programs..... | 37 |
| 7.15 Emergencies..... | 37 |
| 7.16 Shop Drawings, Samples, and Other Submittals..... | 37 |
| 7.17 Contractor’s General Warranty and Guarantee | 39 |
| 7.18 Indemnification..... | 40 |
| 7.19 Delegation of Professional Design Services | 40 |
| ARTICLE 8 – Other Work at the Site..... | 41 |
| 8.01 Other Work | 41 |
| 8.02 Coordination | 41 |
| 8.03 Legal Relationships..... | 42 |
| ARTICLE 9 – Owner’s Responsibilities | 42 |
| 9.01 Communications to Contractor | 42 |
| 9.02 Replacement of Engineer..... | 43 |

| | | |
|--|---|----|
| 9.03 | Furnish Data | 43 |
| 9.04 | Pay When Due..... | 43 |
| 9.05 | Lands and Easements; Reports, Tests, and Drawings..... | 43 |
| 9.06 | Insurance..... | 43 |
| 9.07 | Change Orders | 43 |
| 9.08 | Inspections, Tests, and Approvals..... | 43 |
| 9.09 | Limitations on Owner’s Responsibilities | 43 |
| 9.10 | Undisclosed Hazardous Environmental Condition..... | 43 |
| 9.11 | Evidence of Financial Arrangements..... | 43 |
| 9.12 | Safety Programs | 43 |
| ARTICLE 10 – Engineer’s Status During Construction | | 44 |
| 10.01 | Owner’s Representative..... | 44 |
| 10.02 | Visits to Site..... | 44 |
| 10.03 | Project Representative..... | 44 |
| 10.04 | Rejecting Defective Work | 44 |
| 10.05 | Shop Drawings, Change Orders and Payments..... | 44 |
| 10.06 | Determinations for Unit Price Work | 45 |
| 10.07 | Decisions on Requirements of Contract Documents and Acceptability of Work | 45 |
| 10.08 | Limitations on Engineer’s Authority and Responsibilities | 45 |
| 10.09 | Compliance with Safety Program..... | 45 |
| ARTICLE 11 – Amending the Contract Documents; Changes in the Work..... | | 45 |
| 11.01 | Amending and Supplementing Contract Documents | 45 |
| 11.02 | Owner-Authorized Changes in the Work | 46 |
| 11.03 | Unauthorized Changes in the Work..... | 46 |
| 11.04 | Change of Contract Price | 47 |
| 11.05 | Change of Contract Times..... | 48 |
| 11.06 | Change Proposals..... | 48 |
| 11.07 | Execution of Change Orders | 48 |
| 11.08 | Notification to Surety..... | 49 |
| ARTICLE 12 – Claims | | 49 |
| 12.01 | Claims..... | 49 |
| ARTICLE 13 – Cost of the Work; Allowances; Unit Price Work | | 50 |
| 13.01 | Cost of the Work | 50 |
| 13.02 | Allowances | 52 |
| 13.03 | Unit Price Work..... | 53 |

| | |
|--|----|
| ARTICLE 14 – Tests and Inspections; Correction, Removal or Acceptance of Defective Work | 53 |
| 14.01 Access to Work..... | 53 |
| 14.02 Tests, Inspections, and Approvals..... | 54 |
| 14.03 Defective Work | 54 |
| 14.04 Acceptance of Defective Work | 55 |
| 14.05 Uncovering Work | 55 |
| 14.06 Owner May Stop the Work | 56 |
| 14.07 Owner May Correct Defective Work..... | 56 |
| ARTICLE 15 – Payments to Contractor; Set-Offs; Completion; Correction Period | 56 |
| 15.01 Progress Payments..... | 56 |
| 15.02 Contractor’s Warranty of Title | 59 |
| 15.03 Substantial Completion..... | 59 |
| 15.04 Partial Use or Occupancy | 60 |
| 15.05 Final Inspection | 61 |
| 15.06 Final Payment..... | 61 |
| 15.07 Waiver of Claims | 62 |
| 15.08 Correction Period | 62 |
| ARTICLE 16 – Suspension of Work and Termination | 63 |
| 16.01 Owner May Suspend Work | 63 |
| 16.02 Owner May Terminate for Cause..... | 63 |
| 16.03 Owner May Terminate For Convenience..... | 64 |
| 16.04 Contractor May Stop Work or Terminate | 64 |
| ARTICLE 17 – Final Resolution of Disputes | 65 |
| 17.01 Methods and Procedures..... | 65 |
| ARTICLE 18 – Miscellaneous | 65 |
| 18.01 Giving Notice..... | 65 |
| 18.02 Computation of Times | 65 |
| 18.03 Cumulative Remedies | 65 |
| 18.04 Limitation of Damages | 65 |
| 18.05 No Waiver | 66 |
| 18.06 Survival of Obligations | 66 |
| 18.07 Controlling Law | 66 |
| 18.08 Headings..... | 66 |

ARTICLE 1 – DEFINITIONS AND TERMINOLOGY

1.01 *Defined Terms*

- A. Wherever used in the Bidding Requirements or Contract Documents, a term printed with initial capital letters, including the term's singular and plural forms, will have the meaning indicated in the definitions below. In addition to terms specifically defined, terms with initial capital letters in the Contract Documents include references to identified articles and paragraphs, and the titles of other documents or forms.
1. *Addenda*—Written or graphic instruments issued prior to the opening of Bids which clarify, correct, or change the Bidding Requirements or the proposed Contract Documents.
 2. *Agreement*—The written instrument, executed by Owner and Contractor, that sets forth the Contract Price and Contract Times, identifies the parties and the Engineer, and designates the specific items that are Contract Documents.
 3. *Application for Payment*—The form acceptable to Engineer which is to be used by Contractor during the course of the Work in requesting progress or final payments and which is to be accompanied by such supporting documentation as is required by the Contract Documents.
 4. *Bid*—The offer of a Bidder submitted on the prescribed form setting forth the prices for the Work to be performed.
 5. *Bidder*—An individual or entity that submits a Bid to Owner.
 6. *Bidding Documents*—The Bidding Requirements, the proposed Contract Documents, and all Addenda.
 7. *Bidding Requirements*—The advertisement or invitation to bid, Instructions to Bidders, Bid Bond or other Bid security, if any, the Bid Form, and the Bid with any attachments.
 8. *Change Order*—A document which is signed by Contractor and Owner and authorizes an addition, deletion, or revision in the Work or an adjustment in the Contract Price or the Contract Times, or other revision to the Contract, issued on or after the Effective Date of the Contract.
 9. *Change Proposal*—A written request by Contractor, duly submitted in compliance with the procedural requirements set forth herein, seeking an adjustment in Contract Price or Contract Times, or both; contesting an initial decision by Engineer concerning the requirements of the Contract Documents or the acceptability of Work under the Contract Documents; challenging a set-off against payments due; or seeking other relief with respect to the terms of the Contract.
 10. *Claim*—(a) A demand or assertion by Owner directly to Contractor, duly submitted in compliance with the procedural requirements set forth herein: seeking an adjustment of Contract Price or Contract Times, or both; contesting an initial decision by Engineer concerning the requirements of the Contract Documents or the acceptability of Work under the Contract Documents; contesting Engineer's decision regarding a Change Proposal; seeking resolution of a contractual issue that Engineer has declined to address; or seeking other relief with respect to the terms of the Contract; or (b) a demand or assertion by Contractor directly to Owner, duly submitted in compliance with the procedural requirements set forth herein, contesting Engineer's decision regarding a Change Proposal; or seeking resolution of a contractual issue that Engineer has declined to address. A demand for money or services by a third party is not a Claim.
 11. *Constituent of Concern*—Asbestos, petroleum, radioactive materials, polychlorinated biphenyls (PCBs), hazardous waste, and any substance, product, waste, or other material of any nature

whatsoever that is or becomes listed, regulated, or addressed pursuant to (a) the Comprehensive Environmental Response, Compensation and Liability Act, 42 U.S.C. §§9601 et seq. ("CERCLA"); (b) the Hazardous Materials Transportation Act, 49 U.S.C. §§5101 et seq.; (c) the Resource Conservation and Recovery Act, 42 U.S.C. §§6901 et seq. ("RCRA"); (d) the Toxic Substances Control Act, 15 U.S.C. §§2601 et seq.; (e) the Clean Water Act, 33 U.S.C. §§1251 et seq.; (f) the Clean Air Act, 42 U.S.C. §§7401 et seq.; or (g) any other federal, state, or local statute, law, rule, regulation, ordinance, resolution, code, order, or decree regulating, relating to, or imposing liability or standards of conduct concerning, any hazardous, toxic, or dangerous waste, substance, or material.

12. *Contract*—The entire and integrated written contract between the Owner and Contractor concerning the Work.
13. *Contract Documents*—Those items so designated in the Agreement, and which together comprise the Contract.
14. *Contract Price*—The money that Owner has agreed to pay Contractor for completion of the Work in accordance with the Contract Documents. .
15. *Contract Times*—The number of days or the dates by which Contractor shall: (a) achieve Milestones, if any; (b) achieve Substantial Completion; and (c) complete the Work.
16. *Contractor*—The individual or entity with which Owner has contracted for performance of the Work.
17. *Cost of the Work*—See Paragraph 13.01 for definition.
18. *Drawings*—The part of the Contract that graphically shows the scope, extent, and character of the Work to be performed by Contractor.
19. *Effective Date of the Contract*—The date, indicated in the Agreement, on which the Contract becomes effective.
20. *Engineer*—The individual or entity named as such in the Agreement.
21. *Field Order*—A written order issued by Engineer which requires minor changes in the Work but does not change the Contract Price or the Contract Times.
22. *Hazardous Environmental Condition*—The presence at the Site of Constituents of Concern in such quantities or circumstances that may present a danger to persons or property exposed thereto. The presence at the Site of materials that are necessary for the execution of the Work, or that are to be incorporated in the Work, and that are controlled and contained pursuant to industry practices, Laws and Regulations, and the requirements of the Contract, does not establish a Hazardous Environmental Condition.
23. *Laws and Regulations; Laws or Regulations*—Any and all applicable laws, statutes, rules, regulations, ordinances, codes, and orders of any and all governmental bodies, agencies, authorities, and courts having jurisdiction.
24. *Liens*—Charges, security interests, or encumbrances upon Contract-related funds, real property, or personal property.
25. *Milestone*—A principal event in the performance of the Work that the Contract requires Contractor to achieve by an intermediate completion date or by a time prior to Substantial Completion of all the Work.
26. *Notice of Award*—The written notice by Owner to a Bidder of Owner's acceptance of the Bid.

27. *Notice to Proceed*—A written notice by Owner to Contractor fixing the date on which the Contract Times will commence to run and on which Contractor shall start to perform the Work.
28. *Owner*—The individual or entity with which Contractor has contracted regarding the Work, and which has agreed to pay Contractor for the performance of the Work, pursuant to the terms of the Contract.
29. *Progress Schedule*—A schedule, prepared and maintained by Contractor, describing the sequence and duration of the activities comprising the Contractor’s plan to accomplish the Work within the Contract Times.
30. *Project*—The total undertaking to be accomplished for Owner by engineers, contractors, and others, including planning, study, design, construction, testing, commissioning, and start-up, and of which the Work to be performed under the Contract Documents is a part.
31. *Project Manual*—The written documents prepared for, or made available for, procuring and constructing the Work, including but not limited to the Bidding Documents or other construction procurement documents, geotechnical and existing conditions information, the Agreement, bond forms, General Conditions, Supplementary Conditions, and Specifications. The contents of the Project Manual may be bound in one or more volumes.
32. *Resident Project Representative*—The authorized representative of Engineer assigned to assist Engineer at the Site. As used herein, the term Resident Project Representative or “RPR” includes any assistants or field staff of Resident Project Representative.
33. *Samples*—Physical examples of materials, equipment, or workmanship that are representative of some portion of the Work and that establish the standards by which such portion of the Work will be judged.
34. *Schedule of Submittals*—A schedule, prepared and maintained by Contractor, of required submittals and the time requirements for Engineer’s review of the submittals and the performance of related construction activities.
35. *Schedule of Values*—A schedule, prepared and maintained by Contractor, allocating portions of the Contract Price to various portions of the Work and used as the basis for reviewing Contractor’s Applications for Payment.
36. *Shop Drawings*—All drawings, diagrams, illustrations, schedules, and other data or information that are specifically prepared or assembled by or for Contractor and submitted by Contractor to illustrate some portion of the Work. Shop Drawings, whether approved or not, are not Drawings and are not Contract Documents.
37. *Site*—Lands or areas indicated in the Contract Documents as being furnished by Owner upon which the Work is to be performed, including rights-of-way and easements, and such other lands furnished by Owner which are designated for the use of Contractor.
38. *Specifications*—The part of the Contract that consists of written requirements for materials, equipment, systems, standards, and workmanship as applied to the Work, and certain administrative requirements and procedural matters applicable to the Work.
39. *Subcontractor*—An individual or entity having a direct contract with Contractor or with any other Subcontractor for the performance of a part of the Work.
40. *Substantial Completion*—The time at which the Work (or a specified part thereof) has progressed to the point where, in the opinion of Engineer, the Work (or a specified part thereof) is sufficiently complete, in accordance with the Contract Documents, so that the Work (or a specified part thereof) can be utilized for the purposes for which it is intended. The terms

“substantially complete” and “substantially completed” as applied to all or part of the Work refer to Substantial Completion thereof.

41. *Successful Bidder*—The Bidder whose Bid the Owner accepts, and to which the Owner makes an award of contract, subject to stated conditions.
42. *Supplementary Conditions*—The part of the Contract that amends or supplements these General Conditions.
43. *Supplier*—A manufacturer, fabricator, supplier, distributor, materialman, or vendor having a direct contract with Contractor or with any Subcontractor to furnish materials or equipment to be incorporated in the Work by Contractor or a Subcontractor.
44. *Technical Data*—Those items expressly identified as Technical Data in the Supplementary Conditions, with respect to either (a) subsurface conditions at the Site, or physical conditions relating to existing surface or subsurface structures at the Site (except Underground Facilities) or (b) Hazardous Environmental Conditions at the Site. If no such express identifications of Technical Data have been made with respect to conditions at the Site, then the data contained in boring logs, recorded measurements of subsurface water levels, laboratory test results, and other factual, objective information regarding conditions at the Site that are set forth in any geotechnical or environmental report prepared for the Project and made available to Contractor are hereby defined as Technical Data with respect to conditions at the Site under Paragraphs 5.03, 5.04, and 5.06.
45. *Underground Facilities*—All underground pipelines, conduits, ducts, cables, wires, manholes, vaults, tanks, tunnels, or other such facilities or attachments, and any encasements containing such facilities, including but not limited to those that convey electricity, gases, steam, liquid petroleum products, telephone or other communications, fiber optic transmissions, cable television, water, wastewater, storm water, other liquids or chemicals, or traffic or other control systems.
46. *Unit Price Work*—Work to be paid for on the basis of unit prices.
47. *Work*—The entire construction or the various separately identifiable parts thereof required to be provided under the Contract Documents. Work includes and is the result of performing or providing all labor, services, and documentation necessary to produce such construction; furnishing, installing, and incorporating all materials and equipment into such construction; and may include related services such as testing, start-up, and commissioning, all as required by the Contract Documents.
48. *Work Change Directive*—A written directive to Contractor issued on or after the Effective Date of the Contract, signed by Owner and recommended by Engineer, ordering an addition, deletion, or revision in the Work.

1.02 Terminology

- A. The words and terms discussed in the following paragraphs are not defined but, when used in the Bidding Requirements or Contract Documents, have the indicated meaning.
- B. *Intent of Certain Terms or Adjectives:*
 1. The Contract Documents include the terms “as allowed,” “as approved,” “as ordered,” “as directed” or terms of like effect or import to authorize an exercise of professional judgment by Engineer. In addition, the adjectives “reasonable,” “suitable,” “acceptable,” “proper,” “satisfactory,” or adjectives of like effect or import are used to describe an action or determination of Engineer as to the Work. It is intended that such exercise of professional judgment, action, or determination will be solely to evaluate, in general, the Work for

compliance with the information in the Contract Documents and with the design concept of the Project as a functioning whole as shown or indicated in the Contract Documents (unless there is a specific statement indicating otherwise). The use of any such term or adjective is not intended to and shall not be effective to assign to Engineer any duty or authority to supervise or direct the performance of the Work, or any duty or authority to undertake responsibility contrary to the provisions of Article 10 or any other provision of the Contract Documents.

C. *Day:*

1. The word "day" means a calendar day of 24 hours measured from midnight to the next midnight.

D. *Defective:*

1. The word "defective," when modifying the word "Work," refers to Work that is unsatisfactory, faulty, or deficient in that it:
 - a. does not conform to the Contract Documents; or
 - b. does not meet the requirements of any applicable inspection, reference standard, test, or approval referred to in the Contract Documents; or
 - c. has been damaged prior to Engineer's recommendation of final payment (unless responsibility for the protection thereof has been assumed by Owner at Substantial Completion in accordance with Paragraph 15.03 or 15.04).

E. *Furnish, Install, Perform, Provide:*

1. The word "furnish," when used in connection with services, materials, or equipment, shall mean to supply and deliver said services, materials, or equipment to the Site (or some other specified location) ready for use or installation and in usable or operable condition.
2. The word "install," when used in connection with services, materials, or equipment, shall mean to put into use or place in final position said services, materials, or equipment complete and ready for intended use.
3. The words "perform" or "provide," when used in connection with services, materials, or equipment, shall mean to furnish and install said services, materials, or equipment complete and ready for intended use.
4. If the Contract Documents establish an obligation of Contractor with respect to specific services, materials, or equipment, but do not expressly use any of the four words "furnish," "install," "perform," or "provide," then Contractor shall furnish and install said services, materials, or equipment complete and ready for intended use.

- F. Unless stated otherwise in the Contract Documents, words or phrases that have a well-known technical or construction industry or trade meaning are used in the Contract Documents in accordance with such recognized meaning.

ARTICLE 2 – PRELIMINARY MATTERS

2.01 *Delivery of Bonds and Evidence of Insurance*

- A. *Bonds:* When Contractor delivers the executed counterparts of the Agreement to Owner, Contractor shall also deliver to Owner such bonds as Contractor may be required to furnish.
- B. *Evidence of Contractor's Insurance:* When Contractor delivers the executed counterparts of the Agreement to Owner, Contractor shall also deliver to Owner, with copies to each named insured and additional insured (as identified in the Supplementary Conditions or elsewhere in the Contract),

the certificates and other evidence of insurance required to be provided by Contractor in accordance with Article 6.

- C. *Evidence of Owner's Insurance:* After receipt of the executed counterparts of the Agreement and all required bonds and insurance documentation, Owner shall promptly deliver to Contractor, with copies to each named insured and additional insured (as identified in the Supplementary Conditions or otherwise), the certificates and other evidence of insurance required to be provided by Owner under Article 6.

2.02 *Copies of Documents*

- A. Owner shall furnish to Contractor four printed copies of the Contract (including one fully executed counterpart of the Agreement), and one copy in electronic portable document format (PDF). Additional printed copies will be furnished upon request at the cost of reproduction.
- B. Owner shall maintain and safeguard at least one original printed record version of the Contract, including Drawings and Specifications signed and sealed by Engineer and other design professionals. Owner shall make such original printed record version of the Contract available to Contractor for review. Owner may delegate the responsibilities under this provision to Engineer.

2.03 *Before Starting Construction*

- A. *Preliminary Schedules:* Within 10 days after the Effective Date of the Contract (or as otherwise specifically required by the Contract Documents), Contractor shall submit to Engineer for timely review:
 - 1. a preliminary Progress Schedule indicating the times (numbers of days or dates) for starting and completing the various stages of the Work, including any Milestones specified in the Contract;
 - 2. a preliminary Schedule of Submittals; and
 - 3. a preliminary Schedule of Values for all of the Work which includes quantities and prices of items which when added together equal the Contract Price and subdivides the Work into component parts in sufficient detail to serve as the basis for progress payments during performance of the Work. Such prices will include an appropriate amount of overhead and profit applicable to each item of Work.

2.04 *Preconstruction Conference; Designation of Authorized Representatives*

- A. Before any Work at the Site is started, a conference attended by Owner, Contractor, Engineer, and others as appropriate will be held to establish a working understanding among the parties as to the Work and to discuss the schedules referred to in Paragraph 2.03.A, procedures for handling Shop Drawings, Samples, and other submittals, processing Applications for Payment, electronic or digital transmittals, and maintaining required records.
- B. At this conference Owner and Contractor each shall designate, in writing, a specific individual to act as its authorized representative with respect to the services and responsibilities under the Contract. Such individuals shall have the authority to transmit and receive information, render decisions relative to the Contract, and otherwise act on behalf of each respective party.

2.05 *Initial Acceptance of Schedules*

- A. At least 10 days before submission of the first Application for Payment a conference, attended by Contractor, Engineer, and others as appropriate, will be held to review for acceptability to Engineer as provided below the schedules submitted in accordance with Paragraph 2.03.A. Contractor shall have an additional 10 days to make corrections and adjustments and to complete and resubmit the

schedules. No progress payment shall be made to Contractor until acceptable schedules are submitted to Engineer.

1. The Progress Schedule will be acceptable to Engineer if it provides an orderly progression of the Work to completion within the Contract Times. Such acceptance will not impose on Engineer responsibility for the Progress Schedule, for sequencing, scheduling, or progress of the Work, nor interfere with or relieve Contractor from Contractor's full responsibility therefor.
2. Contractor's Schedule of Submittals will be acceptable to Engineer if it provides a workable arrangement for reviewing and processing the required submittals.
3. Contractor's Schedule of Values will be acceptable to Engineer as to form and substance if it provides a reasonable allocation of the Contract Price to the component parts of the Work.

2.06 *Electronic Transmittals*

- A. Except as otherwise stated elsewhere in the Contract, the Owner, Engineer, and Contractor may transmit, and shall accept, Project-related correspondence, text, data, documents, drawings, information, and graphics, including but not limited to Shop Drawings and other submittals, in electronic media or digital format, either directly, or through access to a secure Project website.
- B. If the Contract does not establish protocols for electronic or digital transmittals, then Owner, Engineer, and Contractor shall jointly develop such protocols.
- C. When transmitting items in electronic media or digital format, the transmitting party makes no representations as to long term compatibility, usability, or readability of the items resulting from the recipient's use of software application packages, operating systems, or computer hardware differing from those used in the drafting or transmittal of the items, or from those established in applicable transmittal protocols.

ARTICLE 3 – DOCUMENTS: INTENT, REQUIREMENTS, REUSE

3.01 *Intent*

- A. The Contract Documents are complementary; what is required by one is as binding as if required by all.
- B. It is the intent of the Contract Documents to describe a functionally complete project (or part thereof) to be constructed in accordance with the Contract Documents.
- C. Unless otherwise stated in the Contract Documents, if there is a discrepancy between the electronic or digital versions of the Contract Documents (including any printed copies derived from such electronic or digital versions) and the printed record version, the printed record version shall govern.
- D. The Contract supersedes prior negotiations, representations, and agreements, whether written or oral.
- E. Engineer will issue clarifications and interpretations of the Contract Documents as provided herein.

3.02 *Reference Standards*

- A. Standards Specifications, Codes, Laws and Regulations
 1. Reference in the Contract Documents to standard specifications, manuals, reference standards, or codes of any technical society, organization, or association, or to Laws or Regulations, whether such reference be specific or by implication, shall mean the standard specification, manual, reference standard, code, or Laws or Regulations in effect at the time of

opening of Bids (or on the Effective Date of the Contract if there were no Bids), except as may be otherwise specifically stated in the Contract Documents.

2. No provision of any such standard specification, manual, reference standard, or code, or any instruction of a Supplier, shall be effective to change the duties or responsibilities of Owner, Contractor, or Engineer, or any of their subcontractors, consultants, agents, or employees, from those set forth in the part of the Contract Documents prepared by or for Engineer. No such provision or instruction shall be effective to assign to Owner, Engineer, or any of their officers, directors, members, partners, employees, agents, consultants, or subcontractors, any duty or authority to supervise or direct the performance of the Work or any duty or authority to undertake responsibility inconsistent with the provisions of the part of the Contract Documents prepared by or for Engineer.

3.03 *Reporting and Resolving Discrepancies*

A. *Reporting Discrepancies:*

1. *Contractor's Verification of Figures and Field Measurements:* Before undertaking each part of the Work, Contractor shall carefully study the Contract Documents, and check and verify pertinent figures and dimensions therein, particularly with respect to applicable field measurements. Contractor shall promptly report in writing to Engineer any conflict, error, ambiguity, or discrepancy that Contractor discovers, or has actual knowledge of, and shall not proceed with any Work affected thereby until the conflict, error, ambiguity, or discrepancy is resolved, by a clarification or interpretation by Engineer, or by an amendment or supplement to the Contract Documents issued pursuant to Paragraph 11.01.
2. *Contractor's Review of Contract Documents:* If, before or during the performance of the Work, Contractor discovers any conflict, error, ambiguity, or discrepancy within the Contract Documents, or between the Contract Documents and (a) any applicable Law or Regulation, (b) actual field conditions, (c) any standard specification, manual, reference standard, or code, or (d) any instruction of any Supplier, then Contractor shall promptly report it to Engineer in writing. Contractor shall not proceed with the Work affected thereby (except in an emergency as required by Paragraph 7.15) until the conflict, error, ambiguity, or discrepancy is resolved, by a clarification or interpretation by Engineer, or by an amendment or supplement to the Contract Documents issued pursuant to Paragraph 11.01.
3. Contractor shall not be liable to Owner or Engineer for failure to report any conflict, error, ambiguity, or discrepancy in the Contract Documents unless Contractor had actual knowledge thereof.

B. *Resolving Discrepancies:*

1. Except as may be otherwise specifically stated in the Contract Documents, the provisions of the part of the Contract Documents prepared by or for Engineer shall take precedence in resolving any conflict, error, ambiguity, or discrepancy between such provisions of the Contract Documents and:
 - a. the provisions of any standard specification, manual, reference standard, or code, or the instruction of any Supplier (whether or not specifically incorporated by reference as a Contract Document); or
 - b. the provisions of any Laws or Regulations applicable to the performance of the Work (unless such an interpretation of the provisions of the Contract Documents would result in violation of such Law or Regulation).

3.04 *Requirements of the Contract Documents*

- A. During the performance of the Work and until final payment, Contractor and Owner shall submit to the Engineer all matters in question concerning the requirements of the Contract Documents (sometimes referred to as requests for information or interpretation—RFIs), or relating to the acceptability of the Work under the Contract Documents, as soon as possible after such matters arise. Engineer will be the initial interpreter of the requirements of the Contract Documents, and judge of the acceptability of the Work thereunder.
- B. Engineer will, with reasonable promptness, render a written clarification, interpretation, or decision on the issue submitted, or initiate an amendment or supplement to the Contract Documents. Engineer's written clarification, interpretation, or decision will be final and binding on Contractor, unless it appeals by submitting a Change Proposal, and on Owner, unless it appeals by filing a Claim.
- C. If a submitted matter in question concerns terms and conditions of the Contract Documents that do not involve (1) the performance or acceptability of the Work under the Contract Documents, (2) the design (as set forth in the Drawings, Specifications, or otherwise), or (3) other engineering or technical matters, then Engineer will promptly give written notice to Owner and Contractor that Engineer is unable to provide a decision or interpretation. If Owner and Contractor are unable to agree on resolution of such a matter in question, either party may pursue resolution as provided in Article 12.

3.05 *Reuse of Documents*

- A. Contractor and its Subcontractors and Suppliers shall not:
 - 1. have or acquire any title to or ownership rights in any of the Drawings, Specifications, or other documents (or copies of any thereof) prepared by or bearing the seal of Engineer or its consultants, including electronic media editions, or reuse any such Drawings, Specifications, other documents, or copies thereof on extensions of the Project or any other project without written consent of Owner and Engineer and specific written verification or adaptation by Engineer; or
 - 2. have or acquire any title or ownership rights in any other Contract Documents, reuse any such Contract Documents for any purpose without Owner's express written consent, or violate any copyrights pertaining to such Contract Documents.
- B. The prohibitions of this Paragraph 3.05 will survive final payment, or termination of the Contract. Nothing herein shall preclude Contractor from retaining copies of the Contract Documents for record purposes.

ARTICLE 4 – COMMENCEMENT AND PROGRESS OF THE WORK

4.01 *Commencement of Contract Times; Notice to Proceed*

- A. The Contract Times will commence to run on the thirtieth day after the Effective Date of the Contract or, if a Notice to Proceed is given, on the day indicated in the Notice to Proceed. A Notice to Proceed may be given at any time within 30 days after the Effective Date of the Contract. In no event will the Contract Times commence to run later than the sixtieth day after the day of Bid opening or the thirtieth day after the Effective Date of the Contract, whichever date is earlier.

4.02 *Starting the Work*

- A. Contractor shall start to perform the Work on the date when the Contract Times commence to run. No Work shall be done at the Site prior to such date.

4.03 *Reference Points*

- A. Owner shall provide engineering surveys to establish reference points for construction which in Engineer's judgment are necessary to enable Contractor to proceed with the Work. Contractor shall be responsible for laying out the Work, shall protect and preserve the established reference points and property monuments, and shall make no changes or relocations without the prior written approval of Owner. Contractor shall report to Engineer whenever any reference point or property monument is lost or destroyed or requires relocation because of necessary changes in grades or locations, and shall be responsible for the accurate replacement or relocation of such reference points or property monuments by professionally qualified personnel.

4.04 *Progress Schedule*

- A. Contractor shall adhere to the Progress Schedule established in accordance with Paragraph 2.05 as it may be adjusted from time to time as provided below.
 - 1. Contractor shall submit to Engineer for acceptance (to the extent indicated in Paragraph 2.05) proposed adjustments in the Progress Schedule that will not result in changing the Contract Times.
 - 2. Proposed adjustments in the Progress Schedule that will change the Contract Times shall be submitted in accordance with the requirements of Article 11.
- B. Contractor shall carry on the Work and adhere to the Progress Schedule during all disputes or disagreements with Owner. No Work shall be delayed or postponed pending resolution of any disputes or disagreements, or during any appeal process, except as permitted by Paragraph 16.04, or as Owner and Contractor may otherwise agree in writing.

4.05 *Delays in Contractor's Progress*

- A. If Owner, Engineer, or anyone for whom Owner is responsible, delays, disrupts, or interferes with the performance or progress of the Work, then Contractor shall be entitled to an equitable adjustment in the Contract Times and Contract Price. Contractor's entitlement to an adjustment of the Contract Times is conditioned on such adjustment being essential to Contractor's ability to complete the Work within the Contract Times.
- B. Contractor shall not be entitled to an adjustment in Contract Price or Contract Times for delay, disruption, or interference caused by or within the control of Contractor. Delay, disruption, and interference attributable to and within the control of a Subcontractor or Supplier shall be deemed to be within the control of Contractor.
- C. If Contractor's performance or progress is delayed, disrupted, or interfered with by unanticipated causes not the fault of and beyond the control of Owner, Contractor, and those for which they are responsible, then Contractor shall be entitled to an equitable adjustment in Contract Times. Contractor's entitlement to an adjustment of the Contract Times is conditioned on such adjustment being essential to Contractor's ability to complete the Work within the Contract Times. Such an adjustment shall be Contractor's sole and exclusive remedy for the delays, disruption, and interference described in this paragraph. Causes of delay, disruption, or interference that may give rise to an adjustment in Contract Times under this paragraph include but are not limited to the following:
 - 1. severe and unavoidable natural catastrophes such as fires, floods, epidemics, and earthquakes;
 - 2. abnormal weather conditions;
 - 3. acts or failures to act of utility owners (other than those performing other work at or adjacent to the Site by arrangement with the Owner, as contemplated in Article 8); and

4. acts of war or terrorism.
- D. Delays, disruption, and interference to the performance or progress of the Work resulting from the existence of a differing subsurface or physical condition, an Underground Facility that was not shown or indicated by the Contract Documents, or not shown or indicated with reasonable accuracy, and those resulting from Hazardous Environmental Conditions, are governed by Article 5.
- E. Paragraph 8.03 governs delays, disruption, and interference to the performance or progress of the Work resulting from the performance of certain other work at or adjacent to the Site.
- F. Contractor shall not be entitled to an adjustment in Contract Price or Contract Times for any delay, disruption, or interference if such delay is concurrent with a delay, disruption, or interference caused by or within the control of Contractor.
- G. Contractor must submit any Change Proposal seeking an adjustment in Contract Price or Contract Times under this paragraph within 30 days of the commencement of the delaying, disrupting, or interfering event.

ARTICLE 5 – AVAILABILITY OF LANDS; SUBSURFACE AND PHYSICAL CONDITIONS; HAZARDOUS ENVIRONMENTAL CONDITIONS

5.01 *Availability of Lands*

- A. Owner shall furnish the Site. Owner shall notify Contractor of any encumbrances or restrictions not of general application but specifically related to use of the Site with which Contractor must comply in performing the Work.
- B. Upon reasonable written request, Owner shall furnish Contractor with a current statement of record legal title and legal description of the lands upon which permanent improvements are to be made and Owner's interest therein as necessary for giving notice of or filing a mechanic's or construction lien against such lands in accordance with applicable Laws and Regulations.
- C. Contractor shall provide for all additional lands and access thereto that may be required for temporary construction facilities or storage of materials and equipment.

5.02 *Use of Site and Other Areas*

- A. *Limitation on Use of Site and Other Areas:*
 1. Contractor shall confine construction equipment, temporary construction facilities, the storage of materials and equipment, and the operations of workers to the Site, adjacent areas that Contractor has arranged to use through construction easements or otherwise, and other adjacent areas permitted by Laws and Regulations, and shall not unreasonably encumber the Site and such other adjacent areas with construction equipment or other materials or equipment. Contractor shall assume full responsibility for (a) damage to the Site; (b) damage to any such other adjacent areas used for Contractor's operations; (c) damage to any other adjacent land or areas; and (d) for injuries and losses sustained by the owners or occupants of any such land or areas; provided that such damage or injuries result from the performance of the Work or from other actions or conduct of the Contractor or those for which Contractor is responsible.
 2. If a damage or injury claim is made by the owner or occupant of any such land or area because of the performance of the Work, or because of other actions or conduct of the Contractor or those for which Contractor is responsible, Contractor shall (a) take immediate corrective or remedial action as required by Paragraph 7.12, or otherwise; (b) promptly attempt to settle the claim as to all parties through negotiations with such owner or occupant, or otherwise resolve the claim by arbitration or other dispute resolution proceeding, or at law; and (c) to

the fullest extent permitted by Laws and Regulations, indemnify and hold harmless Owner and Engineer, and the officers, directors, members, partners, employees, agents, consultants and subcontractors of each and any of them from and against any such claim, and against all costs, losses, and damages (including but not limited to all fees and charges of engineers, architects, attorneys, and other professionals and all court or arbitration or other dispute resolution costs) arising out of or relating to any claim or action, legal or equitable, brought by any such owner or occupant against Owner, Engineer, or any other party indemnified hereunder to the extent caused directly or indirectly, in whole or in part by, or based upon, Contractor's performance of the Work, or because of other actions or conduct of the Contractor or those for which Contractor is responsible.

- B. *Removal of Debris During Performance of the Work:* During the progress of the Work the Contractor shall keep the Site and other adjacent areas free from accumulations of waste materials, rubbish, and other debris. Removal and disposal of such waste materials, rubbish, and other debris shall conform to applicable Laws and Regulations.
- C. *Cleaning:* Prior to Substantial Completion of the Work Contractor shall clean the Site and the Work and make it ready for utilization by Owner. At the completion of the Work Contractor shall remove from the Site and adjacent areas all tools, appliances, construction equipment and machinery, and surplus materials and shall restore to original condition all property not designated for alteration by the Contract Documents.
- D. *Loading of Structures:* Contractor shall not load nor permit any part of any structure to be loaded in any manner that will endanger the structure, nor shall Contractor subject any part of the Work or adjacent structures or land to stresses or pressures that will endanger them.

5.03 *Subsurface and Physical Conditions*

- A. *Reports and Drawings:* The Supplementary Conditions identify:
 - 1. those reports known to Owner of explorations and tests of subsurface conditions at or adjacent to the Site;
 - 2. those drawings known to Owner of physical conditions relating to existing surface or subsurface structures at the Site (except Underground Facilities); and
 - 3. Technical Data contained in such reports and drawings.
- B. *Reliance by Contractor on Technical Data Authorized:* Contractor may rely upon the accuracy of the Technical Data expressly identified in the Supplementary Conditions with respect to such reports and drawings, but such reports and drawings are not Contract Documents. If no such express identification has been made, then Contractor may rely upon the accuracy of the Technical Data (as defined in Article 1) contained in any geotechnical or environmental report prepared for the Project and made available to Contractor. Except for such reliance on Technical Data, Contractor may not rely upon or make any claim against Owner or Engineer, or any of their officers, directors, members, partners, employees, agents, consultants, or subcontractors, with respect to:
 - 1. the completeness of such reports and drawings for Contractor's purposes, including, but not limited to, any aspects of the means, methods, techniques, sequences, and procedures of construction to be employed by Contractor, and safety precautions and programs incident thereto; or
 - 2. other data, interpretations, opinions, and information contained in such reports or shown or indicated in such drawings; or
 - 3. any Contractor interpretation of or conclusion drawn from any Technical Data or any such other data, interpretations, opinions, or information.

5.04 *Differing Subsurface or Physical Conditions*

- A. *Notice by Contractor:* If Contractor believes that any subsurface or physical condition that is uncovered or revealed at the Site either:
1. is of such a nature as to establish that any Technical Data on which Contractor is entitled to rely as provided in Paragraph 5.03 is materially inaccurate; or
 2. is of such a nature as to require a change in the Drawings or Specifications; or
 3. differs materially from that shown or indicated in the Contract Documents; or
 4. is of an unusual nature, and differs materially from conditions ordinarily encountered and generally recognized as inherent in work of the character provided for in the Contract Documents;

then Contractor shall, promptly after becoming aware thereof and before further disturbing the subsurface or physical conditions or performing any Work in connection therewith (except in an emergency as required by Paragraph 7.15), notify Owner and Engineer in writing about such condition. Contractor shall not further disturb such condition or perform any Work in connection therewith (except with respect to an emergency) until receipt of a written statement permitting Contractor to do so.

- B. *Engineer's Review:* After receipt of written notice as required by the preceding paragraph, Engineer will promptly review the subsurface or physical condition in question; determine the necessity of Owner's obtaining additional exploration or tests with respect to the condition; conclude whether the condition falls within any one or more of the differing site condition categories in Paragraph 5.04.A above; obtain any pertinent cost or schedule information from Contractor; prepare recommendations to Owner regarding the Contractor's resumption of Work in connection with the subsurface or physical condition in question and the need for any change in the Drawings or Specifications; and advise Owner in writing of Engineer's findings, conclusions, and recommendations.
- C. *Owner's Statement to Contractor Regarding Site Condition:* After receipt of Engineer's written findings, conclusions, and recommendations, Owner shall issue a written statement to Contractor (with a copy to Engineer) regarding the subsurface or physical condition in question, addressing the resumption of Work in connection with such condition, indicating whether any change in the Drawings or Specifications will be made, and adopting or rejecting Engineer's written findings, conclusions, and recommendations, in whole or in part.
- D. *Possible Price and Times Adjustments:*
1. Contractor shall be entitled to an equitable adjustment in Contract Price or Contract Times, or both, to the extent that the existence of a differing subsurface or physical condition, or any related delay, disruption, or interference, causes an increase or decrease in Contractor's cost of, or time required for, performance of the Work; subject, however, to the following:
 - a. such condition must fall within any one or more of the categories described in Paragraph 5.04.A;
 - b. with respect to Work that is paid for on a unit price basis, any adjustment in Contract Price will be subject to the provisions of Paragraph 13.03; and,
 - c. Contractor's entitlement to an adjustment of the Contract Times is conditioned on such adjustment being essential to Contractor's ability to complete the Work within the Contract Times.

2. Contractor shall not be entitled to any adjustment in the Contract Price or Contract Times with respect to a subsurface or physical condition if:
 - a. Contractor knew of the existence of such condition at the time Contractor made a commitment to Owner with respect to Contract Price and Contract Times by the submission of a Bid or becoming bound under a negotiated contract, or otherwise; or
 - b. the existence of such condition reasonably could have been discovered or revealed as a result of any examination, investigation, exploration, test, or study of the Site and contiguous areas expressly required by the Bidding Requirements or Contract Documents to be conducted by or for Contractor prior to Contractor's making such commitment; or
 - c. Contractor failed to give the written notice as required by Paragraph 5.04.A.
3. If Owner and Contractor agree regarding Contractor's entitlement to and the amount or extent of any adjustment in the Contract Price or Contract Times, or both, then any such adjustment shall be set forth in a Change Order.
4. Contractor may submit a Change Proposal regarding its entitlement to or the amount or extent of any adjustment in the Contract Price or Contract Times, or both, no later than 30 days after Owner's issuance of the Owner's written statement to Contractor regarding the subsurface or physical condition in question.

5.05 *Underground Facilities*

- A. *Contractor's Responsibilities:* The information and data shown or indicated in the Contract Documents with respect to existing Underground Facilities at or adjacent to the Site is based on information and data furnished to Owner or Engineer by the owners of such Underground Facilities, including Owner, or by others. Unless it is otherwise expressly provided in the Supplementary Conditions:
 1. Owner and Engineer do not warrant or guarantee the accuracy or completeness of any such information or data provided by others; and
 2. the cost of all of the following will be included in the Contract Price, and Contractor shall have full responsibility for:
 - a. reviewing and checking all information and data regarding existing Underground Facilities at the Site;
 - b. locating all Underground Facilities shown or indicated in the Contract Documents as being at the Site;
 - c. coordination of the Work with the owners (including Owner) of such Underground Facilities, during construction; and
 - d. the safety and protection of all existing Underground Facilities at the Site, and repairing any damage thereto resulting from the Work.
- B. *Notice by Contractor:* If Contractor believes that an Underground Facility that is uncovered or revealed at the Site was not shown or indicated in the Contract Documents, or was not shown or indicated with reasonable accuracy, then Contractor shall, promptly after becoming aware thereof and before further disturbing conditions affected thereby or performing any Work in connection therewith (except in an emergency as required by Paragraph 7.15), identify the owner of such Underground Facility and give written notice to that owner and to Owner and Engineer.
- C. *Engineer's Review:* Engineer will promptly review the Underground Facility and conclude whether such Underground Facility was not shown or indicated in the Contract Documents, or was not shown or indicated with reasonable accuracy; obtain any pertinent cost or schedule information

from Contractor; prepare recommendations to Owner regarding the Contractor's resumption of Work in connection with the Underground Facility in question; determine the extent, if any, to which a change is required in the Drawings or Specifications to reflect and document the consequences of the existence or location of the Underground Facility; and advise Owner in writing of Engineer's findings, conclusions, and recommendations. During such time, Contractor shall be responsible for the safety and protection of such Underground Facility.

- D. *Owner's Statement to Contractor Regarding Underground Facility:* After receipt of Engineer's written findings, conclusions, and recommendations, Owner shall issue a written statement to Contractor (with a copy to Engineer) regarding the Underground Facility in question, addressing the resumption of Work in connection with such Underground Facility, indicating whether any change in the Drawings or Specifications will be made, and adopting or rejecting Engineer's written findings, conclusions, and recommendations in whole or in part.
- E. *Possible Price and Times Adjustments:*
1. Contractor shall be entitled to an equitable adjustment in the Contract Price or Contract Times, or both, to the extent that any existing Underground Facility at the Site that was not shown or indicated in the Contract Documents, or was not shown or indicated with reasonable accuracy, or any related delay, disruption, or interference, causes an increase or decrease in Contractor's cost of, or time required for, performance of the Work; subject, however, to the following:
 - a. Contractor did not know of and could not reasonably have been expected to be aware of or to have anticipated the existence or actual location of the Underground Facility in question;
 - b. With respect to Work that is paid for on a unit price basis, any adjustment in Contract Price will be subject to the provisions of Paragraph 13.03;
 - c. Contractor's entitlement to an adjustment of the Contract Times is conditioned on such adjustment being essential to Contractor's ability to complete the Work within the Contract Times; and
 - d. Contractor gave the notice required in Paragraph 5.05.B.
 2. If Owner and Contractor agree regarding Contractor's entitlement to and the amount or extent of any adjustment in the Contract Price or Contract Times, or both, then any such adjustment shall be set forth in a Change Order.
 3. Contractor may submit a Change Proposal regarding its entitlement to or the amount or extent of any adjustment in the Contract Price or Contract Times, or both, no later than 30 days after Owner's issuance of the Owner's written statement to Contractor regarding the Underground Facility in question.

5.06 *Hazardous Environmental Conditions at Site*

- A. *Reports and Drawings:* The Supplementary Conditions identify:
1. those reports and drawings known to Owner relating to Hazardous Environmental Conditions that have been identified at or adjacent to the Site; and
 2. Technical Data contained in such reports and drawings.
- B. *Reliance by Contractor on Technical Data Authorized:* Contractor may rely upon the accuracy of the Technical Data expressly identified in the Supplementary Conditions with respect to such reports and drawings, but such reports and drawings are not Contract Documents. If no such express identification has been made, then Contractor may rely on the accuracy of the Technical Data (as

defined in Article 1) contained in any geotechnical or environmental report prepared for the Project and made available to Contractor. Except for such reliance on Technical Data, Contractor may not rely upon or make any claim against Owner or Engineer, or any of their officers, directors, members, partners, employees, agents, consultants, or subcontractors with respect to:

1. the completeness of such reports and drawings for Contractor's purposes, including, but not limited to, any aspects of the means, methods, techniques, sequences and procedures of construction to be employed by Contractor and safety precautions and programs incident thereto; or
 2. other data, interpretations, opinions and information contained in such reports or shown or indicated in such drawings; or
 3. any Contractor interpretation of or conclusion drawn from any Technical Data or any such other data, interpretations, opinions or information.
- C. Contractor shall not be responsible for removing or remediating any Hazardous Environmental Condition encountered, uncovered, or revealed at the Site unless such removal or remediation is expressly identified in the Contract Documents to be within the scope of the Work.
- D. Contractor shall be responsible for controlling, containing, and duly removing all Constituents of Concern brought to the Site by Contractor, Subcontractors, Suppliers, or anyone else for whom Contractor is responsible, and for any associated costs; and for the costs of removing and remediating any Hazardous Environmental Condition created by the presence of any such Constituents of Concern.
- E. If Contractor encounters, uncovers, or reveals a Hazardous Environmental Condition whose removal or remediation is not expressly identified in the Contract Documents as being within the scope of the Work, or if Contractor or anyone for whom Contractor is responsible creates a Hazardous Environmental Condition, then Contractor shall immediately: (1) secure or otherwise isolate such condition; (2) stop all Work in connection with such condition and in any area affected thereby (except in an emergency as required by Paragraph 7.15); and (3) notify Owner and Engineer (and promptly thereafter confirm such notice in writing). Owner shall promptly consult with Engineer concerning the necessity for Owner to retain a qualified expert to evaluate such condition or take corrective action, if any. Promptly after consulting with Engineer, Owner shall take such actions as are necessary to permit Owner to timely obtain required permits and provide Contractor the written notice required by Paragraph 5.06.F. If Contractor or anyone for whom Contractor is responsible created the Hazardous Environmental Condition in question, then Owner may remove and remediate the Hazardous Environmental Condition, and impose a set-off against payments to account for the associated costs.
- F. Contractor shall not resume Work in connection with such Hazardous Environmental Condition or in any affected area until after Owner has obtained any required permits related thereto, and delivered written notice to Contractor either (1) specifying that such condition and any affected area is or has been rendered safe for the resumption of Work, or (2) specifying any special conditions under which such Work may be resumed safely.
- G. If Owner and Contractor cannot agree as to entitlement to or on the amount or extent, if any, of any adjustment in Contract Price or Contract Times, or both, as a result of such Work stoppage or such special conditions under which Work is agreed to be resumed by Contractor, then within 30 days of Owner's written notice regarding the resumption of Work, Contractor may submit a Change Proposal, or Owner may impose a set-off.
- H. If after receipt of such written notice Contractor does not agree to resume such Work based on a reasonable belief it is unsafe, or does not agree to resume such Work under such special conditions, then Owner may order the portion of the Work that is in the area affected by such

condition to be deleted from the Work, following the contractual change procedures in Article 11. Owner may have such deleted portion of the Work performed by Owner's own forces or others in accordance with Article 8.

- I. To the fullest extent permitted by Laws and Regulations, Owner shall indemnify and hold harmless Contractor, Subcontractors, and Engineer, and the officers, directors, members, partners, employees, agents, consultants, and subcontractors of each and any of them from and against all claims, costs, losses, and damages (including but not limited to all fees and charges of engineers, architects, attorneys, and other professionals and all court or arbitration or other dispute resolution costs) arising out of or relating to a Hazardous Environmental Condition, provided that such Hazardous Environmental Condition (1) was not shown or indicated in the Drawings, Specifications, or other Contract Documents, identified as Technical Data entitled to limited reliance pursuant to Paragraph 5.06.B, or identified in the Contract Documents to be included within the scope of the Work, and (2) was not created by Contractor or by anyone for whom Contractor is responsible. Nothing in this Paragraph 5.06.I shall obligate Owner to indemnify any individual or entity from and against the consequences of that individual's or entity's own negligence.
- J. To the fullest extent permitted by Laws and Regulations, Contractor shall indemnify and hold harmless Owner and Engineer, and the officers, directors, members, partners, employees, agents, consultants, and subcontractors of each and any of them from and against all claims, costs, losses, and damages (including but not limited to all fees and charges of engineers, architects, attorneys, and other professionals and all court or arbitration or other dispute resolution costs) arising out of or relating to the failure to control, contain, or remove a Constituent of Concern brought to the Site by Contractor or by anyone for whom Contractor is responsible, or to a Hazardous Environmental Condition created by Contractor or by anyone for whom Contractor is responsible. Nothing in this Paragraph 5.06.J shall obligate Contractor to indemnify any individual or entity from and against the consequences of that individual's or entity's own negligence.
- K. The provisions of Paragraphs 5.03, 5.04, and 5.05 do not apply to the presence of Constituents of Concern or to a Hazardous Environmental Condition uncovered or revealed at the Site.

ARTICLE 6 – BONDS AND INSURANCE

6.01 *Performance, Payment, and Other Bonds*

- A. Contractor shall furnish a performance bond and a payment bond, each in an amount at least equal to the Contract Price, as security for the faithful performance and payment of all of Contractor's obligations under the Contract. These bonds shall remain in effect until one year after the date when final payment becomes due or until completion of the correction period specified in Paragraph 15.08, whichever is later, except as provided otherwise by Laws or Regulations, the Supplementary Conditions, or other specific provisions of the Contract. Contractor shall also furnish such other bonds as are required by the Supplementary Conditions or other specific provisions of the Contract.
- B. All bonds shall be in the form prescribed by the Contract except as provided otherwise by Laws or Regulations, and shall be executed by such sureties as are named in "Companies Holding Certificates of Authority as Acceptable Sureties on Federal Bonds and as Acceptable Reinsuring Companies" as published in Circular 570 (as amended and supplemented) by the Financial Management Service, Surety Bond Branch, U.S. Department of the Treasury. A bond signed by an agent or attorney-in-fact must be accompanied by a certified copy of that individual's authority to bind the surety. The evidence of authority shall show that it is effective on the date the agent or attorney-in-fact signed the accompanying bond.

- C. Contractor shall obtain the required bonds from surety companies that are duly licensed or authorized in the jurisdiction in which the Project is located to issue bonds in the required amounts.
- D. If the surety on a bond furnished by Contractor is declared bankrupt or becomes insolvent, or its right to do business is terminated in any state or jurisdiction where any part of the Project is located, or the surety ceases to meet the requirements above, then Contractor shall promptly notify Owner and Engineer and shall, within 20 days after the event giving rise to such notification, provide another bond and surety, both of which shall comply with the bond and surety requirements above.
- E. If Contractor has failed to obtain a required bond, Owner may exclude the Contractor from the Site and exercise Owner's termination rights under Article 16.
- F. Upon request, Owner shall provide a copy of the payment bond to any Subcontractor, Supplier, or other person or entity claiming to have furnished labor or materials used in the performance of the Work.

6.02 *Insurance—General Provisions*

- A. Owner and Contractor shall obtain and maintain insurance as required in this Article and in the Supplementary Conditions.
- B. All insurance required by the Contract to be purchased and maintained by Owner or Contractor shall be obtained from insurance companies that are duly licensed or authorized, in the state or jurisdiction in which the Project is located, to issue insurance policies for the required limits and coverages. Unless a different standard is indicated in the Supplementary Conditions, all companies that provide insurance policies required under this Contract shall have an A.M. Best rating of A-VII or better.
- C. Contractor shall deliver to Owner, with copies to each named insured and additional insured (as identified in this Article, in the Supplementary Conditions, or elsewhere in the Contract), certificates of insurance establishing that Contractor has obtained and is maintaining the policies, coverages, and endorsements required by the Contract. Upon request by Owner or any other insured, Contractor shall also furnish other evidence of such required insurance, including but not limited to copies of policies and endorsements, and documentation of applicable self-insured retentions and deductibles. Contractor may block out (redact) any confidential premium or pricing information contained in any policy or endorsement furnished under this provision.
- D. Owner shall deliver to Contractor, with copies to each named insured and additional insured (as identified in this Article, the Supplementary Conditions, or elsewhere in the Contract), certificates of insurance establishing that Owner has obtained and is maintaining the policies, coverages, and endorsements required of Owner by the Contract (if any). Upon request by Contractor or any other insured, Owner shall also provide other evidence of such required insurance (if any), including but not limited to copies of policies and endorsements, and documentation of applicable self-insured retentions and deductibles. Owner may block out (redact) any confidential premium or pricing information contained in any policy or endorsement furnished under this provision.
- E. Failure of Owner or Contractor to demand such certificates or other evidence of the other party's full compliance with these insurance requirements, or failure of Owner or Contractor to identify a deficiency in compliance from the evidence provided, shall not be construed as a waiver of the other party's obligation to obtain and maintain such insurance.
- F. If either party does not purchase or maintain all of the insurance required of such party by the Contract, such party shall notify the other party in writing of such failure to purchase prior to the start of the Work, or of such failure to maintain prior to any change in the required coverage.

- G. If Contractor has failed to obtain and maintain required insurance, Owner may exclude the Contractor from the Site, impose an appropriate set-off against payment, and exercise Owner's termination rights under Article 16.
- H. Without prejudice to any other right or remedy, if a party has failed to obtain required insurance, the other party may elect to obtain equivalent insurance to protect such other party's interests at the expense of the party who was required to provide such coverage, and the Contract Price shall be adjusted accordingly.
- I. Owner does not represent that insurance coverage and limits established in this Contract necessarily will be adequate to protect Contractor or Contractor's interests.
- J. The insurance and insurance limits required herein shall not be deemed as a limitation on Contractor's liability under the indemnities granted to Owner and other individuals and entities in the Contract.

6.03 *Contractor's Insurance*

- A. *Workers' Compensation:* Contractor shall purchase and maintain workers' compensation and employer's liability insurance for:
 - 1. claims under workers' compensation, disability benefits, and other similar employee benefit acts.
 - 2. United States Longshoreman and Harbor Workers' Compensation Act and Jones Act coverage (if applicable).
 - 3. claims for damages because of bodily injury, occupational sickness or disease, or death of Contractor's employees (by stop-gap endorsement in monopolist worker's compensation states).
 - 4. Foreign voluntary worker compensation (if applicable).
- B. *Commercial General Liability—Claims Covered:* Contractor shall purchase and maintain commercial general liability insurance, covering all operations by or on behalf of Contractor, on an occurrence basis, against:
 - 1. claims for damages because of bodily injury, sickness or disease, or death of any person other than Contractor's employees.
 - 2. claims for damages insured by reasonably available personal injury liability coverage.
 - 3. claims for damages, other than to the Work itself, because of injury to or destruction of tangible property wherever located, including loss of use resulting therefrom.
- C. *Commercial General Liability—Form and Content:* Contractor's commercial liability policy shall be written on a 1996 (or later) ISO commercial general liability form (occurrence form) and include the following coverages and endorsements:
 - 1. Products and completed operations coverage:
 - a. Such insurance shall be maintained for three years after final payment.
 - b. Contractor shall furnish Owner and each other additional insured (as identified in the Supplementary Conditions or elsewhere in the Contract) evidence of continuation of such insurance at final payment and three years thereafter.
 - 2. Blanket contractual liability coverage, to the extent permitted by law, including but not limited to coverage of Contractor's contractual indemnity obligations in Paragraph 7.18.
 - 3. Broad form property damage coverage.

4. Severability of interest.
 5. Underground, explosion, and collapse coverage.
 6. Personal injury coverage.
 7. Additional insured endorsements that include both ongoing operations and products and completed operations coverage through ISO Endorsements CG 20 10 10 01 and CG 20 37 10 01 (together); or CG 20 10 07 04 and CG 20 37 07 04 (together); or their equivalent.
 8. For design professional additional insureds, ISO Endorsement CG 20 32 07 04, "Additional Insured—Engineers, Architects or Surveyors Not Engaged by the Named Insured" or its equivalent.
- D. *Automobile liability:* Contractor shall purchase and maintain automobile liability insurance against claims for damages because of bodily injury or death of any person or property damage arising out of the ownership, maintenance, or use of any motor vehicle. The automobile liability policy shall be written on an occurrence basis.
- E. *Umbrella or excess liability:* Contractor shall purchase and maintain umbrella or excess liability insurance written over the underlying employer's liability, commercial general liability, and automobile liability insurance described in the paragraphs above. Subject to industry-standard exclusions, the coverage afforded shall follow form as to each and every one of the underlying policies.
- F. *Contractor's pollution liability insurance:* Contractor shall purchase and maintain a policy covering third-party injury and property damage claims, including clean-up costs, as a result of pollution conditions arising from Contractor's operations and completed operations. This insurance shall be maintained for no less than three years after final completion.
- G. *Additional insureds:* The Contractor's commercial general liability, automobile liability, umbrella or excess, and pollution liability policies shall include and list as additional insureds Owner and Engineer, and any individuals or entities identified in the Supplementary Conditions; include coverage for the respective officers, directors, members, partners, employees, agents, consultants, and subcontractors of each and any of all such additional insureds; and the insurance afforded to these additional insureds shall provide primary coverage for all claims covered thereby (including as applicable those arising from both ongoing and completed operations) on a non-contributory basis. Contractor shall obtain all necessary endorsements to support these requirements.
- H. *Contractor's professional liability insurance:* If Contractor will provide or furnish professional services under this Contract, through a delegation of professional design services or otherwise, then Contractor shall be responsible for purchasing and maintaining applicable professional liability insurance. This insurance shall provide protection against claims arising out of performance of professional design or related services, and caused by a negligent error, omission, or act for which the insured party is legally liable. It shall be maintained throughout the duration of the Contract and for a minimum of two years after Substantial Completion. If such professional design services are performed by a Subcontractor, and not by Contractor itself, then the requirements of this paragraph may be satisfied through the purchasing and maintenance of such insurance by such Subcontractor.
- I. *General provisions:* The policies of insurance required by this Paragraph 6.03 shall:
1. include at least the specific coverages provided in this Article.
 2. be written for not less than the limits of liability provided in this Article and in the Supplementary Conditions, or required by Laws or Regulations, whichever is greater.

3. contain a provision or endorsement that the coverage afforded will not be canceled, materially changed, or renewal refused until at least 10 days prior written notice has been given to Contractor. Within three days of receipt of any such written notice, Contractor shall provide a copy of the notice to Owner, Engineer, and each other insured under the policy.
 4. remain in effect at least until final payment (and longer if expressly required in this Article) and at all times thereafter when Contractor may be correcting, removing, or replacing defective Work as a warranty or correction obligation, or otherwise, or returning to the Site to conduct other tasks arising from the Contract Documents.
 5. be appropriate for the Work being performed and provide protection from claims that may arise out of or result from Contractor's performance of the Work and Contractor's other obligations under the Contract Documents, whether it is to be performed by Contractor, any Subcontractor or Supplier, or by anyone directly or indirectly employed by any of them to perform any of the Work, or by anyone for whose acts any of them may be liable.
- J. The coverage requirements for specific policies of insurance must be met by such policies, and not by reference to excess or umbrella insurance provided in other policies.

6.04 *Owner's Liability Insurance*

- A. In addition to the insurance required to be provided by Contractor under Paragraph 6.03, Owner, at Owner's option, may purchase and maintain at Owner's expense Owner's own liability insurance as will protect Owner against claims which may arise from operations under the Contract Documents.
- B. Owner's liability policies, if any, operate separately and independently from policies required to be provided by Contractor, and Contractor cannot rely upon Owner's liability policies for any of Contractor's obligations to the Owner, Engineer, or third parties.

6.05 *Property Insurance*

- A. *Builder's Risk:* Unless otherwise provided in the Supplementary Conditions, Contractor shall purchase and maintain builder's risk insurance upon the Work on a completed value basis, in the amount of the full insurable replacement cost thereof (subject to such deductible amounts as may be provided in the Supplementary Conditions or required by Laws and Regulations). This insurance shall:
 1. include the Owner and Contractor as named insureds, and all Subcontractors, and any individuals or entities required by the Supplementary Conditions to be insured under such builder's risk policy, as insureds or named insureds. For purposes of the remainder of this Paragraph 6.05, Paragraphs 6.06 and 6.07, and any corresponding Supplementary Conditions, the parties required to be insured shall collectively be referred to as "insureds."
 2. be written on a builder's risk "all risk" policy form that shall at least include insurance for physical loss or damage to the Work, temporary buildings, falsework, and materials and equipment in transit, and shall insure against at least the following perils or causes of loss: fire; lightning; windstorm; riot; civil commotion; terrorism; vehicle impact; aircraft; smoke; theft; vandalism and malicious mischief; mechanical breakdown, boiler explosion, and artificially generated electric current; earthquake; volcanic activity, and other earth movement; flood; collapse; explosion; debris removal; demolition occasioned by enforcement of Laws and Regulations; water damage (other than that caused by flood); and such other perils or causes of loss as may be specifically required by the Supplementary Conditions. If insurance against mechanical breakdown, boiler explosion, and artificially generated electric current; earthquake; volcanic activity, and other earth movement; or flood, are not commercially available under builder's risk policies, by endorsement or otherwise, such insurance may be provided through other insurance policies acceptable to Owner and Contractor.

3. cover, as insured property, at least the following: (a) the Work and all materials, supplies, machinery, apparatus, equipment, fixtures, and other property of a similar nature that are to be incorporated into or used in the preparation, fabrication, construction, erection, or completion of the Work, including Owner-furnished or assigned property; (b) spare parts inventory required within the scope of the Contract; and (c) temporary works which are not intended to form part of the permanent constructed Work but which are intended to provide working access to the Site, or to the Work under construction, or which are intended to provide temporary support for the Work under construction, including scaffolding, form work, fences, shoring, falsework, and temporary structures.
 4. cover expenses incurred in the repair or replacement of any insured property (including but not limited to fees and charges of engineers and architects).
 5. extend to cover damage or loss to insured property while in temporary storage at the Site or in a storage location outside the Site (but not including property stored at the premises of a manufacturer or Supplier).
 6. extend to cover damage or loss to insured property while in transit.
 7. allow for partial occupation or use of the Work by Owner, such that those portions of the Work that are not yet occupied or used by Owner shall remain covered by the builder's risk insurance.
 8. allow for the waiver of the insurer's subrogation rights, as set forth below.
 9. provide primary coverage for all losses and damages caused by the perils or causes of loss covered.
 10. not include a co-insurance clause.
 11. include an exception for ensuing losses from physical damage or loss with respect to any defective workmanship, design, or materials exclusions.
 12. include performance/hot testing and start-up.
 13. be maintained in effect, subject to the provisions herein regarding Substantial Completion and partial occupancy or use of the Work by Owner, until the Work is complete.
- B. *Notice of Cancellation or Change:* All the policies of insurance (and the certificates or other evidence thereof) required to be purchased and maintained in accordance with this Paragraph 6.05 will contain a provision or endorsement that the coverage afforded will not be canceled or materially changed or renewal refused until at least 10 days prior written notice has been given to the purchasing policyholder. Within three days of receipt of any such written notice, the purchasing policyholder shall provide a copy of the notice to each other insured.
- C. *Deductibles:* The purchaser of any required builder's risk or property insurance shall pay for costs not covered because of the application of a policy deductible.
- D. *Partial Occupancy or Use by Owner:* If Owner will occupy or use a portion or portions of the Work prior to Substantial Completion of all the Work as provided in Paragraph 15.04, then Owner (directly, if it is the purchaser of the builder's risk policy, or through Contractor) will provide notice of such occupancy or use to the builder's risk insurer. The builder's risk insurance shall not be canceled or permitted to lapse on account of any such partial use or occupancy; rather, those portions of the Work that are occupied or used by Owner may come off the builder's risk policy, while those portions of the Work not yet occupied or used by Owner shall remain covered by the builder's risk insurance.

- E. *Additional Insurance*: If Contractor elects to obtain other special insurance to be included in or supplement the builder's risk or property insurance policies provided under this Paragraph 6.05, it may do so at Contractor's expense.
- F. *Insurance of Other Property*: If the express insurance provisions of the Contract do not require or address the insurance of a property item or interest, such as tools, construction equipment, or other personal property owned by Contractor, a Subcontractor, or an employee of Contractor or a Subcontractor, then the entity or individual owning such property item will be responsible for deciding whether to insure it, and if so in what amount.

6.06 *Waiver of Rights*

- A. All policies purchased in accordance with Paragraph 6.05, expressly including the builder's risk policy, shall contain provisions to the effect that in the event of payment of any loss or damage the insurers will have no rights of recovery against any insureds thereunder, or against Engineer or its consultants, or their officers, directors, members, partners, employees, agents, consultants, or subcontractors. Owner and Contractor waive all rights against each other and the respective officers, directors, members, partners, employees, agents, consultants, and subcontractors of each and any of them, for all losses and damages caused by, arising out of, or resulting from any of the perils or causes of loss covered by such policies and any other property insurance applicable to the Work; and, in addition, waive all such rights against Engineer, its consultants, all Subcontractors, all individuals or entities identified in the Supplementary Conditions as insureds, and the officers, directors, members, partners, employees, agents, consultants, and subcontractors of each and any of them, under such policies for losses and damages so caused. None of the above waivers shall extend to the rights that any party making such waiver may have to the proceeds of insurance held by Owner or Contractor as trustee or fiduciary, or otherwise payable under any policy so issued.
- B. Owner waives all rights against Contractor, Subcontractors, and Engineer, and the officers, directors, members, partners, employees, agents, consultants and subcontractors of each and any of them, for:
 - 1. loss due to business interruption, loss of use, or other consequential loss extending beyond direct physical loss or damage to Owner's property or the Work caused by, arising out of, or resulting from fire or other perils whether or not insured by Owner; and
 - 2. loss or damage to the completed Project or part thereof caused by, arising out of, or resulting from fire or other insured peril or cause of loss covered by any property insurance maintained on the completed Project or part thereof by Owner during partial occupancy or use pursuant to Paragraph 15.04, after Substantial Completion pursuant to Paragraph 15.03, or after final payment pursuant to Paragraph 15.06.
- C. Any insurance policy maintained by Owner covering any loss, damage or consequential loss referred to in Paragraph 6.06.B shall contain provisions to the effect that in the event of payment of any such loss, damage, or consequential loss, the insurers will have no rights of recovery against Contractor, Subcontractors, or Engineer, or the officers, directors, members, partners, employees, agents, consultants, or subcontractors of each and any of them.
- D. Contractor shall be responsible for assuring that the agreement under which a Subcontractor performs a portion of the Work contains provisions whereby the Subcontractor waives all rights against Owner, Contractor, all individuals or entities identified in the Supplementary Conditions as insureds, the Engineer and its consultants, and the officers, directors, members, partners, employees, agents, consultants, and subcontractors of each and any of them, for all losses and damages caused by, arising out of, relating to, or resulting from any of the perils or causes of loss covered by builder's risk insurance and any other property insurance applicable to the Work.

6.07 *Receipt and Application of Property Insurance Proceeds*

- A. Any insured loss under the builder's risk and other policies of insurance required by Paragraph 6.05 will be adjusted and settled with the named insured that purchased the policy. Such named insured shall act as fiduciary for the other insureds, and give notice to such other insureds that adjustment and settlement of a claim is in progress. Any other insured may state its position regarding a claim for insured loss in writing within 15 days after notice of such claim.
- B. Proceeds for such insured losses may be made payable by the insurer either jointly to multiple insureds, or to the named insured that purchased the policy in its own right and as fiduciary for other insureds, subject to the requirements of any applicable mortgage clause. A named insured receiving insurance proceeds under the builder's risk and other policies of insurance required by Paragraph 6.05 shall distribute such proceeds in accordance with such agreement as the parties in interest may reach, or as otherwise required under the dispute resolution provisions of this Contract or applicable Laws and Regulations.
- C. If no other special agreement is reached, the damaged Work shall be repaired or replaced, the money so received applied on account thereof, and the Work and the cost thereof covered by Change Order, if needed.

ARTICLE 7 – CONTRACTOR'S RESPONSIBILITIES

7.01 *Supervision and Superintendence*

- A. Contractor shall supervise, inspect, and direct the Work competently and efficiently, devoting such attention thereto and applying such skills and expertise as may be necessary to perform the Work in accordance with the Contract Documents. Contractor shall be solely responsible for the means, methods, techniques, sequences, and procedures of construction.
- B. At all times during the progress of the Work, Contractor shall assign a competent resident superintendent who shall not be replaced without written notice to Owner and Engineer except under extraordinary circumstances.

7.02 *Labor; Working Hours*

- A. Contractor shall provide competent, suitably qualified personnel to survey and lay out the Work and perform construction as required by the Contract Documents. Contractor shall at all times maintain good discipline and order at the Site.
- B. Except as otherwise required for the safety or protection of persons or the Work or property at the Site or adjacent thereto, and except as otherwise stated in the Contract Documents, all Work at the Site shall be performed during regular working hours, Monday through Friday. Contractor will not perform Work on a Saturday, Sunday, or any legal holiday. Contractor may perform Work outside regular working hours or on Saturdays, Sundays, or legal holidays only with Owner's written consent, which will not be unreasonably withheld.

7.03 *Services, Materials, and Equipment*

- A. Unless otherwise specified in the Contract Documents, Contractor shall provide and assume full responsibility for all services, materials, equipment, labor, transportation, construction equipment and machinery, tools, appliances, fuel, power, light, heat, telephone, water, sanitary facilities, temporary facilities, and all other facilities and incidentals necessary for the performance, testing, start up, and completion of the Work, whether or not such items are specifically called for in the Contract Documents.
- B. All materials and equipment incorporated into the Work shall be of good quality and new, except as otherwise provided in the Contract Documents. All special warranties and guarantees required by

the Specifications shall expressly run to the benefit of Owner. If required by Engineer, Contractor shall furnish satisfactory evidence (including reports of required tests) as to the source, kind, and quality of materials and equipment.

- C. All materials and equipment shall be stored, applied, installed, connected, erected, protected, used, cleaned, and conditioned in accordance with instructions of the applicable Supplier, except as otherwise may be provided in the Contract Documents.

7.04 "Or Equals"

- A. Whenever an item of material or equipment is specified or described in the Contract Documents by using the name of a proprietary item or the name of a particular Supplier, the Contract Price has been based upon Contractor furnishing such item as specified. The specification or description of such an item is intended to establish the type, function, appearance, and quality required. Unless the specification or description contains or is followed by words reading that no like, equivalent, or "or equal" item is permitted, Contractor may request that Engineer authorize the use of other items of material or equipment, or items from other proposed suppliers under the circumstances described below.
 - 1. If Engineer in its sole discretion determines that an item of material or equipment proposed by Contractor is functionally equal to that named and sufficiently similar so that no change in related Work will be required, Engineer shall deem it an "or equal" item. For the purposes of this paragraph, a proposed item of material or equipment will be considered functionally equal to an item so named if:
 - a. in the exercise of reasonable judgment Engineer determines that:
 - 1) it is at least equal in materials of construction, quality, durability, appearance, strength, and design characteristics;
 - 2) it will reliably perform at least equally well the function and achieve the results imposed by the design concept of the completed Project as a functioning whole;
 - 3) it has a proven record of performance and availability of responsive service; and
 - 4) it is not objectionable to Owner.
 - b. Contractor certifies that, if approved and incorporated into the Work:
 - 1) there will be no increase in cost to the Owner or increase in Contract Times; and
 - 2) it will conform substantially to the detailed requirements of the item named in the Contract Documents.
- B. *Contractor's Expense:* Contractor shall provide all data in support of any proposed "or equal" item at Contractor's expense.
- C. *Engineer's Evaluation and Determination:* Engineer will be allowed a reasonable time to evaluate each "or-equal" request. Engineer may require Contractor to furnish additional data about the proposed "or-equal" item. Engineer will be the sole judge of acceptability. No "or-equal" item will be ordered, furnished, installed, or utilized until Engineer's review is complete and Engineer determines that the proposed item is an "or-equal", which will be evidenced by an approved Shop Drawing or other written communication. Engineer will advise Contractor in writing of any negative determination.
- D. *Effect of Engineer's Determination:* Neither approval nor denial of an "or-equal" request shall result in any change in Contract Price. The Engineer's denial of an "or-equal" request shall be final and binding, and may not be reversed through an appeal under any provision of the Contract Documents.

- E. *Treatment as a Substitution Request:* If Engineer determines that an item of material or equipment proposed by Contractor does not qualify as an “or-equal” item, Contractor may request that Engineer considered the proposed item as a substitute pursuant to Paragraph 7.05.

7.05 *Substitutes*

- A. Unless the specification or description of an item of material or equipment required to be furnished under the Contract Documents contains or is followed by words reading that no substitution is permitted, Contractor may request that Engineer authorize the use of other items of material or equipment under the circumstances described below. To the extent possible such requests shall be made before commencement of related construction at the Site.
1. Contractor shall submit sufficient information as provided below to allow Engineer to determine if the item of material or equipment proposed is functionally equivalent to that named and an acceptable substitute therefor. Engineer will not accept requests for review of proposed substitute items of material or equipment from anyone other than Contractor.
 2. The requirements for review by Engineer will be as set forth in Paragraph 7.05.B, as supplemented by the Specifications, and as Engineer may decide is appropriate under the circumstances.
 3. Contractor shall make written application to Engineer for review of a proposed substitute item of material or equipment that Contractor seeks to furnish or use. The application:
 - a. shall certify that the proposed substitute item will:
 - 1) perform adequately the functions and achieve the results called for by the general design,
 - 2) be similar in substance to that specified, and
 - 3) be suited to the same use as that specified.
 - b. will state:
 - 1) the extent, if any, to which the use of the proposed substitute item will necessitate a change in Contract Times,
 - 2) whether use of the proposed substitute item in the Work will require a change in any of the Contract Documents (or in the provisions of any other direct contract with Owner for other work on the Project) to adapt the design to the proposed substitute item, and
 - 3) whether incorporation or use of the proposed substitute item in connection with the Work is subject to payment of any license fee or royalty.
 - c. will identify:
 - 1) all variations of the proposed substitute item from that specified, and
 - 2) available engineering, sales, maintenance, repair, and replacement services.
 - d. shall contain an itemized estimate of all costs or credits that will result directly or indirectly from use of such substitute item, including but not limited to changes in Contract Price, shared savings, costs of redesign, and claims of other contractors affected by any resulting change.
- B. *Engineer’s Evaluation and Determination:* Engineer will be allowed a reasonable time to evaluate each substitute request, and to obtain comments and direction from Owner. Engineer may require Contractor to furnish additional data about the proposed substitute item. Engineer will be the sole judge of acceptability. No substitute will be ordered, furnished, installed, or utilized until Engineer’s

review is complete and Engineer determines that the proposed item is an acceptable substitute. Engineer's determination will be evidenced by a Field Order or a proposed Change Order accounting for the substitution itself and all related impacts, including changes in Contract Price or Contract Times. Engineer will advise Contractor in writing of any negative determination.

- C. *Special Guarantee:* Owner may require Contractor to furnish at Contractor's expense a special performance guarantee or other surety with respect to any substitute.
- D. *Reimbursement of Engineer's Cost:* Engineer will record Engineer's costs in evaluating a substitute proposed or submitted by Contractor. Whether or not Engineer approves a substitute so proposed or submitted by Contractor, Contractor shall reimburse Owner for the reasonable charges of Engineer for evaluating each such proposed substitute. Contractor shall also reimburse Owner for the reasonable charges of Engineer for making changes in the Contract Documents (or in the provisions of any other direct contract with Owner) resulting from the acceptance of each proposed substitute.
- E. *Contractor's Expense:* Contractor shall provide all data in support of any proposed substitute at Contractor's expense.
- F. *Effect of Engineer's Determination:* If Engineer approves the substitution request, Contractor shall execute the proposed Change Order and proceed with the substitution. The Engineer's denial of a substitution request shall be final and binding, and may not be reversed through an appeal under any provision of the Contract Documents. Contractor may challenge the scope of reimbursement costs imposed under Paragraph 7.05.D, by timely submittal of a Change Proposal.

7.06 *Concerning Subcontractors, Suppliers, and Others*

- A. Contractor may retain Subcontractors and Suppliers for the performance of parts of the Work. Such Subcontractors and Suppliers must be acceptable to Owner.
- B. Contractor shall retain specific Subcontractors, Suppliers, or other individuals or entities for the performance of designated parts of the Work if required by the Contract to do so.
- C. Subsequent to the submittal of Contractor's Bid or final negotiation of the terms of the Contract, Owner may not require Contractor to retain any Subcontractor, Supplier, or other individual or entity to furnish or perform any of the Work against which Contractor has reasonable objection.
- D. Prior to entry into any binding subcontract or purchase order, Contractor shall submit to Owner the identity of the proposed Subcontractor or Supplier (unless Owner has already deemed such proposed Subcontractor or Supplier acceptable, during the bidding process or otherwise). Such proposed Subcontractor or Supplier shall be deemed acceptable to Owner unless Owner raises a substantive, reasonable objection within five days.
- E. Owner may require the replacement of any Subcontractor, Supplier, or other individual or entity retained by Contractor to perform any part of the Work. Owner also may require Contractor to retain specific replacements; provided, however, that Owner may not require a replacement to which Contractor has a reasonable objection. If Contractor has submitted the identity of certain Subcontractors, Suppliers, or other individuals or entities for acceptance by Owner, and Owner has accepted it (either in writing or by failing to make written objection thereto), then Owner may subsequently revoke the acceptance of any such Subcontractor, Supplier, or other individual or entity so identified solely on the basis of substantive, reasonable objection after due investigation. Contractor shall submit an acceptable replacement for the rejected Subcontractor, Supplier, or other individual or entity.
- F. If Owner requires the replacement of any Subcontractor, Supplier, or other individual or entity retained by Contractor to perform any part of the Work, then Contractor shall be entitled to an adjustment in Contract Price or Contract Times, or both, with respect to the replacement; and

Contractor shall initiate a Change Proposal for such adjustment within 30 days of Owner's requirement of replacement.

- G. No acceptance by Owner of any such Subcontractor, Supplier, or other individual or entity, whether initially or as a replacement, shall constitute a waiver of the right of Owner to the completion of the Work in accordance with the Contract Documents.
- H. On a monthly basis Contractor shall submit to Engineer a complete list of all Subcontractors and Suppliers having a direct contract with Contractor, and of all other Subcontractors and Suppliers known to Contractor at the time of submittal.
- I. Contractor shall be fully responsible to Owner and Engineer for all acts and omissions of the Subcontractors, Suppliers, and other individuals or entities performing or furnishing any of the Work just as Contractor is responsible for Contractor's own acts and omissions.
- J. Contractor shall be solely responsible for scheduling and coordinating the work of Subcontractors, Suppliers, and all other individuals or entities performing or furnishing any of the Work.
- K. Contractor shall restrict all Subcontractors, Suppliers, and such other individuals or entities performing or furnishing any of the Work from communicating with Engineer or Owner, except through Contractor or in case of an emergency, or as otherwise expressly allowed herein.
- L. The divisions and sections of the Specifications and the identifications of any Drawings shall not control Contractor in dividing the Work among Subcontractors or Suppliers or delineating the Work to be performed by any specific trade.
- M. All Work performed for Contractor by a Subcontractor or Supplier shall be pursuant to an appropriate contractual agreement that specifically binds the Subcontractor or Supplier to the applicable terms and conditions of the Contract Documents for the benefit of Owner and Engineer.
- N. Owner may furnish to any Subcontractor or Supplier, to the extent practicable, information about amounts paid to Contractor on account of Work performed for Contractor by the particular Subcontractor or Supplier.
- O. Nothing in the Contract Documents:
 - 1. shall create for the benefit of any such Subcontractor, Supplier, or other individual or entity any contractual relationship between Owner or Engineer and any such Subcontractor, Supplier, or other individual or entity; nor
 - 2. shall create any obligation on the part of Owner or Engineer to pay or to see to the payment of any money due any such Subcontractor, Supplier, or other individual or entity except as may otherwise be required by Laws and Regulations.

7.07 *Patent Fees and Royalties*

- A. Contractor shall pay all license fees and royalties and assume all costs incident to the use in the performance of the Work or the incorporation in the Work of any invention, design, process, product, or device which is the subject of patent rights or copyrights held by others. If a particular invention, design, process, product, or device is specified in the Contract Documents for use in the performance of the Work and if, to the actual knowledge of Owner or Engineer, its use is subject to patent rights or copyrights calling for the payment of any license fee or royalty to others, the existence of such rights shall be disclosed by Owner in the Contract Documents.
- B. To the fullest extent permitted by Laws and Regulations, Owner shall indemnify and hold harmless Contractor, and its officers, directors, members, partners, employees, agents, consultants, and subcontractors from and against all claims, costs, losses, and damages (including but not limited to all fees and charges of engineers, architects, attorneys, and other professionals, and all court or

arbitration or other dispute resolution costs) arising out of or relating to any infringement of patent rights or copyrights incident to the use in the performance of the Work or resulting from the incorporation in the Work of any invention, design, process, product, or device specified in the Contract Documents, but not identified as being subject to payment of any license fee or royalty to others required by patent rights or copyrights.

- C. To the fullest extent permitted by Laws and Regulations, Contractor shall indemnify and hold harmless Owner and Engineer, and the officers, directors, members, partners, employees, agents, consultants and subcontractors of each and any of them from and against all claims, costs, losses, and damages (including but not limited to all fees and charges of engineers, architects, attorneys, and other professionals and all court or arbitration or other dispute resolution costs) arising out of or relating to any infringement of patent rights or copyrights incident to the use in the performance of the Work or resulting from the incorporation in the Work of any invention, design, process, product, or device not specified in the Contract Documents.

7.08 *Permits*

- A. Unless otherwise provided in the Contract Documents, Contractor shall obtain and pay for all construction permits and licenses. Owner shall assist Contractor, when necessary, in obtaining such permits and licenses. Contractor shall pay all governmental charges and inspection fees necessary for the prosecution of the Work which are applicable at the time of the submission of Contractor's Bid (or when Contractor became bound under a negotiated contract). Owner shall pay all charges of utility owners for connections for providing permanent service to the Work

7.09 *Taxes*

- A. Contractor shall pay all sales, consumer, use, and other similar taxes required to be paid by Contractor in accordance with the Laws and Regulations of the place of the Project which are applicable during the performance of the Work.

7.10 *Laws and Regulations*

- A. Contractor shall give all notices required by and shall comply with all Laws and Regulations applicable to the performance of the Work. Except where otherwise expressly required by applicable Laws and Regulations, neither Owner nor Engineer shall be responsible for monitoring Contractor's compliance with any Laws or Regulations.
- B. If Contractor performs any Work or takes any other action knowing or having reason to know that it is contrary to Laws or Regulations, Contractor shall bear all resulting costs and losses, and shall indemnify and hold harmless Owner and Engineer, and the officers, directors, members, partners, employees, agents, consultants, and subcontractors of each and any of them from and against all claims, costs, losses, and damages (including but not limited to all fees and charges of engineers, architects, attorneys, and other professionals and all court or arbitration or other dispute resolution costs) arising out of or relating to such Work or other action. It shall not be Contractor's responsibility to make certain that the Work described in the Contract Documents is in accordance with Laws and Regulations, but this shall not relieve Contractor of Contractor's obligations under Paragraph 3.03.
- C. Owner or Contractor may give notice to the other party of any changes after the submission of Contractor's Bid (or after the date when Contractor became bound under a negotiated contract) in Laws or Regulations having an effect on the cost or time of performance of the Work, including but not limited to changes in Laws or Regulations having an effect on procuring permits and on sales, use, value-added, consumption, and other similar taxes. If Owner and Contractor are unable to agree on entitlement to or on the amount or extent, if any, of any adjustment in Contract Price or Contract Times resulting from such changes, then within 30 days of such notice Contractor may submit a Change Proposal, or Owner may initiate a Claim.

7.11 *Record Documents*

- A. Contractor shall maintain in a safe place at the Site one printed record copy of all Drawings, Specifications, Addenda, Change Orders, Work Change Directives, Field Orders, written interpretations and clarifications, and approved Shop Drawings. Contractor shall keep such record documents in good order and annotate them to show changes made during construction. These record documents, together with all approved Samples, will be available to Engineer for reference. Upon completion of the Work, Contractor shall deliver these record documents to Engineer.

7.12 *Safety and Protection*

- A. Contractor shall be solely responsible for initiating, maintaining, and supervising all safety precautions and programs in connection with the Work. Such responsibility does not relieve Subcontractors of their responsibility for the safety of persons or property in the performance of their work, nor for compliance with applicable safety Laws and Regulations. Contractor shall take all necessary precautions for the safety of, and shall provide the necessary protection to prevent damage, injury, or loss to:
 - 1. all persons on the Site or who may be affected by the Work;
 - 2. all the Work and materials and equipment to be incorporated therein, whether in storage on or off the Site; and
 - 3. other property at the Site or adjacent thereto, including trees, shrubs, lawns, walks, pavements, roadways, structures, other work in progress, utilities, and Underground Facilities not designated for removal, relocation, or replacement in the course of construction.
- B. Contractor shall comply with all applicable Laws and Regulations relating to the safety of persons or property, or to the protection of persons or property from damage, injury, or loss; and shall erect and maintain all necessary safeguards for such safety and protection. Contractor shall notify Owner; the owners of adjacent property, Underground Facilities, and other utilities; and other contractors and utility owners performing work at or adjacent to the Site, when prosecution of the Work may affect them, and shall cooperate with them in the protection, removal, relocation, and replacement of their property or work in progress.
- C. Contractor shall comply with the applicable requirements of Owner's safety programs, if any. The Supplementary Conditions identify any Owner's safety programs that are applicable to the Work.
- D. Contractor shall inform Owner and Engineer of the specific requirements of Contractor's safety program with which Owner's and Engineer's employees and representatives must comply while at the Site.
- E. All damage, injury, or loss to any property referred to in Paragraph 7.12.A.2 or 7.12.A.3 caused, directly or indirectly, in whole or in part, by Contractor, any Subcontractor, Supplier, or any other individual or entity directly or indirectly employed by any of them to perform any of the Work, or anyone for whose acts any of them may be liable, shall be remedied by Contractor at its expense (except damage or loss attributable to the fault of Drawings or Specifications or to the acts or omissions of Owner or Engineer or anyone employed by any of them, or anyone for whose acts any of them may be liable, and not attributable, directly or indirectly, in whole or in part, to the fault or negligence of Contractor or any Subcontractor, Supplier, or other individual or entity directly or indirectly employed by any of them).
- F. Contractor's duties and responsibilities for safety and protection shall continue until such time as all the Work is completed and Engineer has issued a notice to Owner and Contractor in accordance with Paragraph 15.06.B that the Work is acceptable (except as otherwise expressly provided in connection with Substantial Completion).

- G. Contractor's duties and responsibilities for safety and protection shall resume whenever Contractor or any Subcontractor or Supplier returns to the Site to fulfill warranty or correction obligations, or to conduct other tasks arising from the Contract Documents.

7.13 *Safety Representative*

- A. Contractor shall designate a qualified and experienced safety representative at the Site whose duties and responsibilities shall be the prevention of accidents and the maintaining and supervising of safety precautions and programs.

7.14 *Hazard Communication Programs*

- A. Contractor shall be responsible for coordinating any exchange of material safety data sheets or other hazard communication information required to be made available to or exchanged between or among employers at the Site in accordance with Laws or Regulations.

7.15 *Emergencies*

- A. In emergencies affecting the safety or protection of persons or the Work or property at the Site or adjacent thereto, Contractor is obligated to act to prevent threatened damage, injury, or loss. Contractor shall give Engineer prompt written notice if Contractor believes that any significant changes in the Work or variations from the Contract Documents have been caused thereby or are required as a result thereof. If Engineer determines that a change in the Contract Documents is required because of the action taken by Contractor in response to such an emergency, a Work Change Directive or Change Order will be issued.

7.16 *Shop Drawings, Samples, and Other Submittals*

A. *Shop Drawing and Sample Submittal Requirements:*

1. Before submitting a Shop Drawing or Sample, Contractor shall have:
 - a. reviewed and coordinated the Shop Drawing or Sample with other Shop Drawings and Samples and with the requirements of the Work and the Contract Documents;
 - b. determined and verified all field measurements, quantities, dimensions, specified performance and design criteria, installation requirements, materials, catalog numbers, and similar information with respect thereto;
 - c. determined and verified the suitability of all materials and equipment offered with respect to the indicated application, fabrication, shipping, handling, storage, assembly, and installation pertaining to the performance of the Work; and
 - d. determined and verified all information relative to Contractor's responsibilities for means, methods, techniques, sequences, and procedures of construction, and safety precautions and programs incident thereto.
2. Each submittal shall bear a stamp or specific written certification that Contractor has satisfied Contractor's obligations under the Contract Documents with respect to Contractor's review of that submittal, and that Contractor approves the submittal.
3. With each submittal, Contractor shall give Engineer specific written notice of any variations that the Shop Drawing or Sample may have from the requirements of the Contract Documents. This notice shall be set forth in a written communication separate from the Shop Drawings or Sample submittal; and, in addition, in the case of Shop Drawings by a specific notation made on each Shop Drawing submitted to Engineer for review and approval of each such variation.

- B. *Submittal Procedures for Shop Drawings and Samples:* Contractor shall submit Shop Drawings and Samples to Engineer for review and approval in accordance with the accepted Schedule of Submittals. Each submittal will be identified as Engineer may require.

1. *Shop Drawings:*
 - a. Contractor shall submit the number of copies required in the Specifications.
 - b. Data shown on the Shop Drawings will be complete with respect to quantities, dimensions, specified performance and design criteria, materials, and similar data to show Engineer the services, materials, and equipment Contractor proposes to provide and to enable Engineer to review the information for the limited purposes required by Paragraph 7.16.D.
2. *Samples:*
 - a. Contractor shall submit the number of Samples required in the Specifications.
 - b. Contractor shall clearly identify each Sample as to material, Supplier, pertinent data such as catalog numbers, the use for which intended and other data as Engineer may require to enable Engineer to review the submittal for the limited purposes required by Paragraph 7.16.D.
3. Where a Shop Drawing or Sample is required by the Contract Documents or the Schedule of Submittals, any related Work performed prior to Engineer's review and approval of the pertinent submittal will be at the sole expense and responsibility of Contractor.
- C. *Other Submittals:* Contractor shall submit other submittals to Engineer in accordance with the accepted Schedule of Submittals, and pursuant to the applicable terms of the Specifications.
- D. *Engineer's Review:*
 1. Engineer will provide timely review of Shop Drawings and Samples in accordance with the Schedule of Submittals acceptable to Engineer. Engineer's review and approval will be only to determine if the items covered by the submittals will, after installation or incorporation in the Work, conform to the information given in the Contract Documents and be compatible with the design concept of the completed Project as a functioning whole as indicated by the Contract Documents.
 2. Engineer's review and approval will not extend to means, methods, techniques, sequences, or procedures of construction or to safety precautions or programs incident thereto.
 3. Engineer's review and approval of a separate item as such will not indicate approval of the assembly in which the item functions.
 4. Engineer's review and approval of a Shop Drawing or Sample shall not relieve Contractor from responsibility for any variation from the requirements of the Contract Documents unless Contractor has complied with the requirements of Paragraph 7.16.A.3 and Engineer has given written approval of each such variation by specific written notation thereof incorporated in or accompanying the Shop Drawing or Sample. Engineer will document any such approved variation from the requirements of the Contract Documents in a Field Order.
 5. Engineer's review and approval of a Shop Drawing or Sample shall not relieve Contractor from responsibility for complying with the requirements of Paragraph 7.16.A and B.
 6. Engineer's review and approval of a Shop Drawing or Sample, or of a variation from the requirements of the Contract Documents, shall not, under any circumstances, change the Contract Times or Contract Price, unless such changes are included in a Change Order.
 7. Neither Engineer's receipt, review, acceptance or approval of a Shop Drawing, Sample, or other submittal shall result in such item becoming a Contract Document.
 8. Contractor shall perform the Work in compliance with the requirements and commitments set forth in approved Shop Drawings and Samples, subject to the provisions of Paragraph 7.16.D.4.

E. *Resubmittal Procedures:*

1. Contractor shall make corrections required by Engineer and shall return the required number of corrected copies of Shop Drawings and submit, as required, new Samples for review and approval. Contractor shall direct specific attention in writing to revisions other than the corrections called for by Engineer on previous submittals.
2. Contractor shall furnish required submittals with sufficient information and accuracy to obtain required approval of an item with no more than three submittals. Engineer will record Engineer's time for reviewing a fourth or subsequent submittal of a Shop Drawings, sample, or other item requiring approval, and Contractor shall be responsible for Engineer's charges to Owner for such time. Owner may impose a set-off against payments due to Contractor to secure reimbursement for such charges.
3. If Contractor requests a change of a previously approved submittal item, Contractor shall be responsible for Engineer's charges to Owner for its review time, and Owner may impose a set-off against payments due to Contractor to secure reimbursement for such charges, unless the need for such change is beyond the control of Contractor.

7.17 *Contractor's General Warranty and Guarantee*

- A. Contractor warrants and guarantees to Owner that all Work will be in accordance with the Contract Documents and will not be defective. Engineer and its officers, directors, members, partners, employees, agents, consultants, and subcontractors shall be entitled to rely on Contractor's warranty and guarantee.
- B. Contractor's warranty and guarantee hereunder excludes defects or damage caused by:
 1. abuse, modification, or improper maintenance or operation by persons other than Contractor, Subcontractors, Suppliers, or any other individual or entity for whom Contractor is responsible;
or
 2. normal wear and tear under normal usage.
- C. Contractor's obligation to perform and complete the Work in accordance with the Contract Documents shall be absolute. None of the following will constitute an acceptance of Work that is not in accordance with the Contract Documents or a release of Contractor's obligation to perform the Work in accordance with the Contract Documents:
 1. observations by Engineer;
 2. recommendation by Engineer or payment by Owner of any progress or final payment;
 3. the issuance of a certificate of Substantial Completion by Engineer or any payment related thereto by Owner;
 4. use or occupancy of the Work or any part thereof by Owner;
 5. any review and approval of a Shop Drawing or Sample submittal;
 6. the issuance of a notice of acceptability by Engineer;
 7. any inspection, test, or approval by others; or
 8. any correction of defective Work by Owner.
- D. If the Contract requires the Contractor to accept the assignment of a contract entered into by Owner, then the specific warranties, guarantees, and correction obligations contained in the assigned contract shall govern with respect to Contractor's performance obligations to Owner for the Work described in the assigned contract.

7.18 *Indemnification*

- A. To the fullest extent permitted by Laws and Regulations, and in addition to any other obligations of Contractor under the Contract or otherwise, Contractor shall indemnify and hold harmless Owner and Engineer, and the officers, directors, members, partners, employees, agents, consultants and subcontractors of each and any of them from and against all claims, costs, losses, and damages (including but not limited to all fees and charges of engineers, architects, attorneys, and other professionals and all court or arbitration or other dispute resolution costs) arising out of or relating to the performance of the Work, provided that any such claim, cost, loss, or damage is attributable to bodily injury, sickness, disease, or death, or to injury to or destruction of tangible property (other than the Work itself), including the loss of use resulting therefrom but only to the extent caused by any negligent act or omission of Contractor, any Subcontractor, any Supplier, or any individual or entity directly or indirectly employed by any of them to perform any of the Work or anyone for whose acts any of them may be liable.
- B. In any and all claims against Owner or Engineer or any of their officers, directors, members, partners, employees, agents, consultants, or subcontractors by any employee (or the survivor or personal representative of such employee) of Contractor, any Subcontractor, any Supplier, or any individual or entity directly or indirectly employed by any of them to perform any of the Work, or anyone for whose acts any of them may be liable, the indemnification obligation under Paragraph 7.18.A shall not be limited in any way by any limitation on the amount or type of damages, compensation, or benefits payable by or for Contractor or any such Subcontractor, Supplier, or other individual or entity under workers' compensation acts, disability benefit acts, or other employee benefit acts.
- C. The indemnification obligations of Contractor under Paragraph 7.18.A shall not extend to the liability of Engineer and Engineer's officers, directors, members, partners, employees, agents, consultants and subcontractors arising out of:
 - 1. the preparation or approval of, or the failure to prepare or approve maps, Drawings, opinions, reports, surveys, Change Orders, designs, or Specifications; or
 - 2. giving directions or instructions, or failing to give them, if that is the primary cause of the injury or damage.

7.19 *Delegation of Professional Design Services*

- A. Contractor will not be required to provide professional design services unless such services are specifically required by the Contract Documents for a portion of the Work or unless such services are required to carry out Contractor's responsibilities for construction means, methods, techniques, sequences and procedures. Contractor shall not be required to provide professional services in violation of applicable Laws and Regulations.
- B. If professional design services or certifications by a design professional related to systems, materials, or equipment are specifically required of Contractor by the Contract Documents, Owner and Engineer will specify all performance and design criteria that such services must satisfy. Contractor shall cause such services or certifications to be provided by a properly licensed professional, whose signature and seal shall appear on all drawings, calculations, specifications, certifications, and other submittals prepared by such professional. Shop Drawings and other submittals related to the Work designed or certified by such professional, if prepared by others, shall bear such professional's written approval when submitted to Engineer.
- C. Owner and Engineer shall be entitled to rely upon the adequacy, accuracy, and completeness of the services, certifications, or approvals performed by such design professionals, provided Owner and Engineer have specified to Contractor all performance and design criteria that such services must satisfy.

- D. Pursuant to this paragraph, Engineer's review and approval of design calculations and design drawings will be only for the limited purpose of checking for conformance with performance and design criteria given and the design concept expressed in the Contract Documents. Engineer's review and approval of Shop Drawings and other submittals (except design calculations and design drawings) will be only for the purpose stated in Paragraph 7.16.D.1.
- E. Contractor shall not be responsible for the adequacy of the performance or design criteria specified by Owner or Engineer.

ARTICLE 8 – OTHER WORK AT THE SITE

8.01 *Other Work*

- A. In addition to and apart from the Work under the Contract Documents, the Owner may perform other work at or adjacent to the Site. Such other work may be performed by Owner's employees, or through contracts between the Owner and third parties. Owner may also arrange to have third-party utility owners perform work on their utilities and facilities at or adjacent to the Site.
- B. If Owner performs other work at or adjacent to the Site with Owner's employees, or through contracts for such other work, then Owner shall give Contractor written notice thereof prior to starting any such other work. If Owner has advance information regarding the start of any utility work at or adjacent to the Site, Owner shall provide such information to Contractor.
- C. Contractor shall afford each other contractor that performs such other work, each utility owner performing other work, and Owner, if Owner is performing other work with Owner's employees, proper and safe access to the Site, and provide a reasonable opportunity for the introduction and storage of materials and equipment and the execution of such other work. Contractor shall do all cutting, fitting, and patching of the Work that may be required to properly connect or otherwise make its several parts come together and properly integrate with such other work. Contractor shall not endanger any work of others by cutting, excavating, or otherwise altering such work; provided, however, that Contractor may cut or alter others' work with the written consent of Engineer and the others whose work will be affected.
- D. If the proper execution or results of any part of Contractor's Work depends upon work performed by others under this Article 8, Contractor shall inspect such other work and promptly report to Engineer in writing any delays, defects, or deficiencies in such other work that render it unavailable or unsuitable for the proper execution and results of Contractor's Work. Contractor's failure to so report will constitute an acceptance of such other work as fit and proper for integration with Contractor's Work except for latent defects and deficiencies in such other work.

8.02 *Coordination*

- A. If Owner intends to contract with others for the performance of other work at or adjacent to the Site, to perform other work at or adjacent to the Site with Owner's employees, or to arrange to have utility owners perform work at or adjacent to the Site, the following will be set forth in the Supplementary Conditions or provided to Contractor prior to the start of any such other work:
 - 1. the identity of the individual or entity that will have authority and responsibility for coordination of the activities among the various contractors;
 - 2. an itemization of the specific matters to be covered by such authority and responsibility; and
 - 3. the extent of such authority and responsibilities.
- B. Unless otherwise provided in the Supplementary Conditions, Owner shall have sole authority and responsibility for such coordination.

8.03 *Legal Relationships*

- A. If, in the course of performing other work at or adjacent to the Site for Owner, the Owner's employees, any other contractor working for Owner, or any utility owner for whom the Owner is responsible causes damage to the Work or to the property of Contractor or its Subcontractors, or delays, disrupts, interferes with, or increases the scope or cost of the performance of the Work, through actions or inaction, then Contractor shall be entitled to an equitable adjustment in the Contract Price or the Contract Times, or both. Contractor must submit any Change Proposal seeking an equitable adjustment in the Contract Price or the Contract Times under this paragraph within 30 days of the damaging, delaying, disrupting, or interfering event. The entitlement to, and extent of, any such equitable adjustment shall take into account information (if any) regarding such other work that was provided to Contractor in the Contract Documents prior to the submittal of the Bid or the final negotiation of the terms of the Contract. When applicable, any such equitable adjustment in Contract Price shall be conditioned on Contractor assigning to Owner all Contractor's rights against such other contractor or utility owner with respect to the damage, delay, disruption, or interference that is the subject of the adjustment. Contractor's entitlement to an adjustment of the Contract Times is conditioned on such adjustment being essential to Contractor's ability to complete the Work within the Contract Times.
- B. Contractor shall take reasonable and customary measures to avoid damaging, delaying, disrupting, or interfering with the work of Owner, any other contractor, or any utility owner performing other work at or adjacent to the Site. If Contractor fails to take such measures and as a result damages, delays, disrupts, or interferes with the work of any such other contractor or utility owner, then Owner may impose a set-off against payments due to Contractor, and assign to such other contractor or utility owner the Owner's contractual rights against Contractor with respect to the breach of the obligations set forth in this paragraph.
- C. When Owner is performing other work at or adjacent to the Site with Owner's employees, Contractor shall be liable to Owner for damage to such other work, and for the reasonable direct delay, disruption, and interference costs incurred by Owner as a result of Contractor's failure to take reasonable and customary measures with respect to Owner's other work. In response to such damage, delay, disruption, or interference, Owner may impose a set-off against payments due to Contractor.
- D. If Contractor damages, delays, disrupts, or interferes with the work of any other contractor, or any utility owner performing other work at or adjacent to the Site, through Contractor's failure to take reasonable and customary measures to avoid such impacts, or if any claim arising out of Contractor's actions, inactions, or negligence in performance of the Work at or adjacent to the Site is made by any such other contractor or utility owner against Contractor, Owner, or Engineer, then Contractor shall (1) promptly attempt to settle the claim as to all parties through negotiations with such other contractor or utility owner, or otherwise resolve the claim by arbitration or other dispute resolution proceeding or at law, and (2) indemnify and hold harmless Owner and Engineer, and the officers, directors, members, partners, employees, agents, consultants and subcontractors of each and any of them from and against any such claims, and against all costs, losses, and damages (including but not limited to all fees and charges of engineers, architects, attorneys, and other professionals and all court or arbitration or other dispute resolution costs) arising out of or relating to such damage, delay, disruption, or interference.

ARTICLE 9 – OWNER'S RESPONSIBILITIES

9.01 *Communications to Contractor*

- A. Except as otherwise provided in these General Conditions, Owner shall issue all communications to Contractor through Engineer.

9.02 *Replacement of Engineer*

- A. Owner may at its discretion appoint an engineer to replace Engineer, provided Contractor makes no reasonable objection to the replacement engineer. The replacement engineer's status under the Contract Documents shall be that of the former Engineer.

9.03 *Furnish Data*

- A. Owner shall promptly furnish the data required of Owner under the Contract Documents.

9.04 *Pay When Due*

- A. Owner shall make payments to Contractor when they are due as provided in the Agreement.

9.05 *Lands and Easements; Reports, Tests, and Drawings*

- A. Owner's duties with respect to providing lands and easements are set forth in Paragraph 5.01.
- B. Owner's duties with respect to providing engineering surveys to establish reference points are set forth in Paragraph 4.03.
- C. Article 5 refers to Owner's identifying and making available to Contractor copies of reports of explorations and tests of conditions at the Site, and drawings of physical conditions relating to existing surface or subsurface structures at the Site.

9.06 *Insurance*

- A. Owner's responsibilities, if any, with respect to purchasing and maintaining liability and property insurance are set forth in Article 6.

9.07 *Change Orders*

- A. Owner's responsibilities with respect to Change Orders are set forth in Article 11.

9.08 *Inspections, Tests, and Approvals*

- A. Owner's responsibility with respect to certain inspections, tests, and approvals is set forth in Paragraph 14.02.B.

9.09 *Limitations on Owner's Responsibilities*

- A. The Owner shall not supervise, direct, or have control or authority over, nor be responsible for, Contractor's means, methods, techniques, sequences, or procedures of construction, or the safety precautions and programs incident thereto, or for any failure of Contractor to comply with Laws and Regulations applicable to the performance of the Work. Owner will not be responsible for Contractor's failure to perform the Work in accordance with the Contract Documents.

9.10 *Undisclosed Hazardous Environmental Condition*

- A. Owner's responsibility in respect to an undisclosed Hazardous Environmental Condition is set forth in Paragraph 5.06.

9.11 *Evidence of Financial Arrangements*

- A. Upon request of Contractor, Owner shall furnish Contractor reasonable evidence that financial arrangements have been made to satisfy Owner's obligations under the Contract Documents (including obligations under proposed changes in the Work).

9.12 *Safety Programs*

- A. While at the Site, Owner's employees and representatives shall comply with the specific applicable requirements of Contractor's safety programs of which Owner has been informed.
- B. Owner shall furnish copies of any applicable Owner safety programs to Contractor.

ARTICLE 10 – ENGINEER’S STATUS DURING CONSTRUCTION

10.01 *Owner’s Representative*

- A. Engineer will be Owner’s representative during the construction period. The duties and responsibilities and the limitations of authority of Engineer as Owner’s representative during construction are set forth in the Contract.

10.02 *Visits to Site*

- A. Engineer will make visits to the Site at intervals appropriate to the various stages of construction as Engineer deems necessary in order to observe as an experienced and qualified design professional the progress that has been made and the quality of the various aspects of Contractor’s executed Work. Based on information obtained during such visits and observations, Engineer, for the benefit of Owner, will determine, in general, if the Work is proceeding in accordance with the Contract Documents. Engineer will not be required to make exhaustive or continuous inspections on the Site to check the quality or quantity of the Work. Engineer’s efforts will be directed toward providing for Owner a greater degree of confidence that the completed Work will conform generally to the Contract Documents. On the basis of such visits and observations, Engineer will keep Owner informed of the progress of the Work and will endeavor to guard Owner against defective Work.
- B. Engineer’s visits and observations are subject to all the limitations on Engineer’s authority and responsibility set forth in Paragraph 10.08. Particularly, but without limitation, during or as a result of Engineer’s visits or observations of Contractor’s Work, Engineer will not supervise, direct, control, or have authority over or be responsible for Contractor’s means, methods, techniques, sequences, or procedures of construction, or the safety precautions and programs incident thereto, or for any failure of Contractor to comply with Laws and Regulations applicable to the performance of the Work.

10.03 *Project Representative*

- A. If Owner and Engineer have agreed that Engineer will furnish a Resident Project Representative to represent Engineer at the Site and assist Engineer in observing the progress and quality of the Work, then the authority and responsibilities of any such Resident Project Representative will be as provided in the Supplementary Conditions, and limitations on the responsibilities thereof will be as provided in Paragraph 10.08. If Owner designates another representative or agent to represent Owner at the Site who is not Engineer’s consultant, agent, or employee, the responsibilities and authority and limitations thereon of such other individual or entity will be as provided in the Supplementary Conditions.

10.04 *Rejecting Defective Work*

- A. Engineer has the authority to reject Work in accordance with Article 14.

10.05 *Shop Drawings, Change Orders and Payments*

- A. Engineer’s authority, and limitations thereof, as to Shop Drawings and Samples, are set forth in Paragraph 7.16.
- B. Engineer’s authority, and limitations thereof, as to design calculations and design drawings submitted in response to a delegation of professional design services, if any, are set forth in Paragraph 7.19.
- C. Engineer’s authority as to Change Orders is set forth in Article 11.
- D. Engineer’s authority as to Applications for Payment is set forth in Article 15.

10.06 *Determinations for Unit Price Work*

- A. Engineer will determine the actual quantities and classifications of Unit Price Work performed by Contractor as set forth in Paragraph 13.03.

10.07 *Decisions on Requirements of Contract Documents and Acceptability of Work*

- A. Engineer will render decisions regarding the requirements of the Contract Documents, and judge the acceptability of the Work, pursuant to the specific procedures set forth herein for initial interpretations, Change Proposals, and acceptance of the Work. In rendering such decisions and judgments, Engineer will not show partiality to Owner or Contractor, and will not be liable to Owner, Contractor, or others in connection with any proceedings, interpretations, decisions, or judgments conducted or rendered in good faith.

10.08 *Limitations on Engineer's Authority and Responsibilities*

- A. Neither Engineer's authority or responsibility under this Article 10 or under any other provision of the Contract, nor any decision made by Engineer in good faith either to exercise or not exercise such authority or responsibility or the undertaking, exercise, or performance of any authority or responsibility by Engineer, shall create, impose, or give rise to any duty in contract, tort, or otherwise owed by Engineer to Contractor, any Subcontractor, any Supplier, any other individual or entity, or to any surety for or employee or agent of any of them.
- B. Engineer will not supervise, direct, control, or have authority over or be responsible for Contractor's means, methods, techniques, sequences, or procedures of construction, or the safety precautions and programs incident thereto, or for any failure of Contractor to comply with Laws and Regulations applicable to the performance of the Work. Engineer will not be responsible for Contractor's failure to perform the Work in accordance with the Contract Documents.
- C. Engineer will not be responsible for the acts or omissions of Contractor or of any Subcontractor, any Supplier, or of any other individual or entity performing any of the Work.
- D. Engineer's review of the final Application for Payment and accompanying documentation and all maintenance and operating instructions, schedules, guarantees, bonds, certificates of inspection, tests and approvals, and other documentation required to be delivered by Paragraph 15.06.A will only be to determine generally that their content complies with the requirements of, and in the case of certificates of inspections, tests, and approvals, that the results certified indicate compliance with the Contract Documents.
- E. The limitations upon authority and responsibility set forth in this Paragraph 10.08 shall also apply to the Resident Project Representative, if any.

10.09 *Compliance with Safety Program*

- A. While at the Site, Engineer's employees and representatives will comply with the specific applicable requirements of Owner's and Contractor's safety programs (if any) of which Engineer has been informed.

ARTICLE 11 – AMENDING THE CONTRACT DOCUMENTS; CHANGES IN THE WORK

11.01 *Amending and Supplementing Contract Documents*

- A. The Contract Documents may be amended or supplemented by a Change Order, a Work Change Directive, or a Field Order.
 - 1. *Change Orders:*
 - a. If an amendment or supplement to the Contract Documents includes a change in the Contract Price or the Contract Times, such amendment or supplement must be set forth

in a Change Order. A Change Order also may be used to establish amendments and supplements of the Contract Documents that do not affect the Contract Price or Contract Times.

- b. Owner and Contractor may amend those terms and conditions of the Contract Documents that do not involve (1) the performance or acceptability of the Work, (2) the design (as set forth in the Drawings, Specifications, or otherwise), or (3) other engineering or technical matters, without the recommendation of the Engineer. Such an amendment shall be set forth in a Change Order.
2. *Work Change Directives:* A Work Change Directive will not change the Contract Price or the Contract Times but is evidence that the parties expect that the modification ordered or documented by a Work Change Directive will be incorporated in a subsequently issued Change Order, following negotiations by the parties as to the Work Change Directive's effect, if any, on the Contract Price and Contract Times; or, if negotiations are unsuccessful, by a determination under the terms of the Contract Documents governing adjustments, expressly including Paragraph 11.04 regarding change of Contract Price. Contractor must submit any Change Proposal seeking an adjustment of the Contract Price or the Contract Times, or both, no later than 30 days after the completion of the Work set out in the Work Change Directive. Owner must submit any Claim seeking an adjustment of the Contract Price or the Contract Times, or both, no later than 60 days after issuance of the Work Change Directive.
3. *Field Orders:* Engineer may authorize minor changes in the Work if the changes do not involve an adjustment in the Contract Price or the Contract Times and are compatible with the design concept of the completed Project as a functioning whole as indicated by the Contract Documents. Such changes will be accomplished by a Field Order and will be binding on Owner and also on Contractor, which shall perform the Work involved promptly. If Contractor believes that a Field Order justifies an adjustment in the Contract Price or Contract Times, or both, then before proceeding with the Work at issue, Contractor shall submit a Change Proposal as provided herein.

11.02 *Owner-Authorized Changes in the Work*

- A. Without invalidating the Contract and without notice to any surety, Owner may, at any time or from time to time, order additions, deletions, or revisions in the Work. Such changes shall be supported by Engineer's recommendation, to the extent the change involves the design (as set forth in the Drawings, Specifications, or otherwise), or other engineering or technical matters. Such changes may be accomplished by a Change Order, if Owner and Contractor have agreed as to the effect, if any, of the changes on Contract Times or Contract Price; or by a Work Change Directive. Upon receipt of any such document, Contractor shall promptly proceed with the Work involved; or, in the case of a deletion in the Work, promptly cease construction activities with respect to such deleted Work. Added or revised Work shall be performed under the applicable conditions of the Contract Documents. Nothing in this paragraph shall obligate Contractor to undertake work that Contractor reasonably concludes cannot be performed in a manner consistent with Contractor's safety obligations under the Contract Documents or Laws and Regulations.

11.03 *Unauthorized Changes in the Work*

- A. Contractor shall not be entitled to an increase in the Contract Price or an extension of the Contract Times with respect to any work performed that is not required by the Contract Documents, as amended, modified, or supplemented, except in the case of an emergency as provided in Paragraph 7.15 or in the case of uncovering Work as provided in Paragraph 14.05.

11.04 *Change of Contract Price*

- A. The Contract Price may only be changed by a Change Order. Any Change Proposal for an adjustment in the Contract Price shall comply with the provisions of Paragraph 11.06. Any Claim for an adjustment of Contract Price shall comply with the provisions of Article 12.
- B. An adjustment in the Contract Price will be determined as follows:
 - 1. where the Work involved is covered by unit prices contained in the Contract Documents, then by application of such unit prices to the quantities of the items involved (subject to the provisions of Paragraph 13.03); or
 - 2. where the Work involved is not covered by unit prices contained in the Contract Documents, then by a mutually agreed lump sum (which may include an allowance for overhead and profit not necessarily in accordance with Paragraph 11.04.C.2); or
 - 3. where the Work involved is not covered by unit prices contained in the Contract Documents and the parties do not reach mutual agreement to a lump sum, then on the basis of the Cost of the Work (determined as provided in Paragraph 13.01) plus a Contractor's fee for overhead and profit (determined as provided in Paragraph 11.04.C).
- C. *Contractor's Fee*: When applicable, the Contractor's fee for overhead and profit shall be determined as follows:
 - 1. a mutually acceptable fixed fee; or
 - 2. if a fixed fee is not agreed upon, then a fee based on the following percentages of the various portions of the Cost of the Work:
 - a. for costs incurred under Paragraphs 13.01.B.1 and 13.01.B.2, the Contractor's fee shall be 15 percent;
 - b. for costs incurred under Paragraph 13.01.B.3, the Contractor's fee shall be five percent;
 - c. where one or more tiers of subcontracts are on the basis of Cost of the Work plus a fee and no fixed fee is agreed upon, the intent of Paragraphs 11.04.C.2.a and 11.04.C.2.b is that the Contractor's fee shall be based on: (1) a fee of 15 percent of the costs incurred under Paragraphs 13.01.A.1 and 13.01.A.2 by the Subcontractor that actually performs the Work, at whatever tier, and (2) with respect to Contractor itself and to any Subcontractors of a tier higher than that of the Subcontractor that actually performs the Work, a fee of five percent of the amount (fee plus underlying costs incurred) attributable to the next lower tier Subcontractor; provided, however, that for any such subcontracted work the maximum total fee to be paid by Owner shall be no greater than 27 percent of the costs incurred by the Subcontractor that actually performs the work;
 - d. no fee shall be payable on the basis of costs itemized under Paragraphs 13.01.B.4, 13.01.B.5, and 13.01.C;
 - e. the amount of credit to be allowed by Contractor to Owner for any change which results in a net decrease in cost will be the amount of the actual net decrease in cost plus a deduction in Contractor's fee by an amount equal to five percent of such net decrease; and
 - f. when both additions and credits are involved in any one change, the adjustment in Contractor's fee shall be computed on the basis of the net change in accordance with Paragraphs 11.04.C.2.a through 11.04.C.2.e, inclusive.

11.05 *Change of Contract Times*

- A. The Contract Times may only be changed by a Change Order. Any Change Proposal for an adjustment in the Contract Times shall comply with the provisions of Paragraph 11.06. Any Claim for an adjustment in the Contract Times shall comply with the provisions of Article 12.
- B. An adjustment of the Contract Times shall be subject to the limitations set forth in Paragraph 4.05, concerning delays in Contractor's progress.

11.06 *Change Proposals*

- A. Contractor shall submit a Change Proposal to Engineer to request an adjustment in the Contract Times or Contract Price; appeal an initial decision by Engineer concerning the requirements of the Contract Documents or relating to the acceptability of the Work under the Contract Documents; contest a set-off against payment due; or seek other relief under the Contract. The Change Proposal shall specify any proposed change in Contract Times or Contract Price, or both, or other proposed relief, and explain the reason for the proposed change, with citations to any governing or applicable provisions of the Contract Documents.
 - 1. *Procedures:* Contractor shall submit each Change Proposal to Engineer promptly (but in no event later than 30 days) after the start of the event giving rise thereto, or after such initial decision. The Contractor shall submit supporting data, including the proposed change in Contract Price or Contract Time (if any), to the Engineer and Owner within 15 days after the submittal of the Change Proposal. The supporting data shall be accompanied by a written statement that the supporting data are accurate and complete, and that any requested time or price adjustment is the entire adjustment to which Contractor believes it is entitled as a result of said event. Engineer will advise Owner regarding the Change Proposal, and consider any comments or response from Owner regarding the Change Proposal.
 - 2. *Engineer's Action:* Engineer will review each Change Proposal and, within 30 days after receipt of the Contractor's supporting data, either deny the Change Proposal in whole, approve it in whole, or deny it in part and approve it in part. Such actions shall be in writing, with a copy provided to Owner and Contractor. If Engineer does not take action on the Change Proposal within 30 days, then either Owner or Contractor may at any time thereafter submit a letter to the other party indicating that as a result of Engineer's inaction the Change Proposal is deemed denied, thereby commencing the time for appeal of the denial under Article 12.
 - 3. *Binding Decision:* Engineer's decision will be final and binding upon Owner and Contractor, unless Owner or Contractor appeals the decision by filing a Claim under Article 12.
- B. *Resolution of Certain Change Proposals:* If the Change Proposal does not involve the design (as set forth in the Drawings, Specifications, or otherwise), the acceptability of the Work, or other engineering or technical matters, then Engineer will notify the parties that the Engineer is unable to resolve the Change Proposal. For purposes of further resolution of such a Change Proposal, such notice shall be deemed a denial, and Contractor may choose to seek resolution under the terms of Article 12.

11.07 *Execution of Change Orders*

- A. Owner and Contractor shall execute appropriate Change Orders covering:
 - 1. changes in the Contract Price or Contract Times which are agreed to by the parties, including any undisputed sum or amount of time for Work actually performed in accordance with a Work Change Directive;
 - 2. changes in Contract Price resulting from an Owner set-off, unless Contractor has duly contested such set-off;

3. changes in the Work which are: (a) ordered by Owner pursuant to Paragraph 11.02, (b) required because of Owner's acceptance of defective Work under Paragraph 14.04 or Owner's correction of defective Work under Paragraph 14.07, or (c) agreed to by the parties, subject to the need for Engineer's recommendation if the change in the Work involves the design (as set forth in the Drawings, Specifications, or otherwise), or other engineering or technical matters; and
 4. changes in the Contract Price or Contract Times, or other changes, which embody the substance of any final and binding results under Paragraph 11.06, or Article 12.
- B. If Owner or Contractor refuses to execute a Change Order that is required to be executed under the terms of this Paragraph 11.07, it shall be deemed to be of full force and effect, as if fully executed.

11.08 *Notification to Surety*

- A. If the provisions of any bond require notice to be given to a surety of any change affecting the general scope of the Work or the provisions of the Contract Documents (including, but not limited to, Contract Price or Contract Times), the giving of any such notice will be Contractor's responsibility. The amount of each applicable bond will be adjusted to reflect the effect of any such change.

ARTICLE 12 – CLAIMS

12.01 *Claims*

- A. *Claims Process:* The following disputes between Owner and Contractor shall be submitted to the Claims process set forth in this Article:
1. Appeals by Owner or Contractor of Engineer's decisions regarding Change Proposals;
 2. Owner demands for adjustments in the Contract Price or Contract Times, or other relief under the Contract Documents; and
 3. Disputes that Engineer has been unable to address because they do not involve the design (as set forth in the Drawings, Specifications, or otherwise), the acceptability of the Work, or other engineering or technical matters.
- B. *Submittal of Claim:* The party submitting a Claim shall deliver it directly to the other party to the Contract promptly (but in no event later than 30 days) after the start of the event giving rise thereto; in the case of appeals regarding Change Proposals within 30 days of the decision under appeal. The party submitting the Claim shall also furnish a copy to the Engineer, for its information only. The responsibility to substantiate a Claim shall rest with the party making the Claim. In the case of a Claim by Contractor seeking an increase in the Contract Times or Contract Price, or both, Contractor shall certify that the Claim is made in good faith, that the supporting data are accurate and complete, and that to the best of Contractor's knowledge and belief the amount of time or money requested accurately reflects the full amount to which Contractor is entitled.
- C. *Review and Resolution:* The party receiving a Claim shall review it thoroughly, giving full consideration to its merits. The two parties shall seek to resolve the Claim through the exchange of information and direct negotiations. The parties may extend the time for resolving the Claim by mutual agreement. All actions taken on a Claim shall be stated in writing and submitted to the other party, with a copy to Engineer.
- D. *Mediation:*
1. At any time after initiation of a Claim, Owner and Contractor may mutually agree to mediation of the underlying dispute. The agreement to mediate shall stay the Claim submittal and response process.

2. If Owner and Contractor agree to mediation, then after 60 days from such agreement, either Owner or Contractor may unilaterally terminate the mediation process, and the Claim submittal and decision process shall resume as of the date of the termination. If the mediation proceeds but is unsuccessful in resolving the dispute, the Claim submittal and decision process shall resume as of the date of the conclusion of the mediation, as determined by the mediator.
 3. Owner and Contractor shall each pay one-half of the mediator's fees and costs.
- E. *Partial Approval:* If the party receiving a Claim approves the Claim in part and denies it in part, such action shall be final and binding unless within 30 days of such action the other party invokes the procedure set forth in Article 17 for final resolution of disputes.
- F. *Denial of Claim:* If efforts to resolve a Claim are not successful, the party receiving the Claim may deny it by giving written notice of denial to the other party. If the receiving party does not take action on the Claim within 90 days, then either Owner or Contractor may at any time thereafter submit a letter to the other party indicating that as a result of the inaction, the Claim is deemed denied, thereby commencing the time for appeal of the denial. A denial of the Claim shall be final and binding unless within 30 days of the denial the other party invokes the procedure set forth in Article 17 for the final resolution of disputes.
- G. *Final and Binding Results:* If the parties reach a mutual agreement regarding a Claim, whether through approval of the Claim, direct negotiations, mediation, or otherwise; or if a Claim is approved in part and denied in part, or denied in full, and such actions become final and binding; then the results of the agreement or action on the Claim shall be incorporated in a Change Order to the extent they affect the Contract, including the Work, the Contract Times, or the Contract Price.

ARTICLE 13 – COST OF THE WORK; ALLOWANCES; UNIT PRICE WORK

13.01 *Cost of the Work*

- A. *Purposes for Determination of Cost of the Work:* The term Cost of the Work means the sum of all costs necessary for the proper performance of the Work at issue, as further defined below. The provisions of this Paragraph 13.01 are used for two distinct purposes:
1. To determine Cost of the Work when Cost of the Work is a component of the Contract Price, under cost-plus-fee, time-and-materials, or other cost-based terms; or
 2. To determine the value of a Change Order, Change Proposal, Claim, set-off, or other adjustment in Contract Price. When the value of any such adjustment is determined on the basis of Cost of the Work, Contractor is entitled only to those additional or incremental costs required because of the change in the Work or because of the event giving rise to the adjustment.
- B. *Costs Included:* Except as otherwise may be agreed to in writing by Owner, costs included in the Cost of the Work shall be in amounts no higher than those prevailing in the locality of the Project, shall not include any of the costs itemized in Paragraph 13.01.C, and shall include only the following items:
1. Payroll costs for employees in the direct employ of Contractor in the performance of the Work under schedules of job classifications agreed upon by Owner and Contractor. Such employees shall include, without limitation, superintendents, foremen, and other personnel employed full time on the Work. Payroll costs for employees not employed full time on the Work shall be apportioned on the basis of their time spent on the Work. Payroll costs shall include, but not be limited to, salaries and wages plus the cost of fringe benefits, which shall include social security contributions, unemployment, excise, and payroll taxes, workers' compensation, health and retirement benefits, bonuses, sick leave, and vacation and holiday pay applicable

thereto. The expenses of performing Work outside of regular working hours, on Saturday, Sunday, or legal holidays, shall be included in the above to the extent authorized by Owner.

2. Cost of all materials and equipment furnished and incorporated in the Work, including costs of transportation and storage thereof, and Suppliers' field services required in connection therewith. All cash discounts shall accrue to Contractor unless Owner deposits funds with Contractor with which to make payments, in which case the cash discounts shall accrue to Owner. All trade discounts, rebates, and refunds and returns from sale of surplus materials and equipment shall accrue to Owner, and Contractor shall make provisions so that they may be obtained.
3. Payments made by Contractor to Subcontractors for Work performed by Subcontractors. If required by Owner, Contractor shall obtain competitive bids from subcontractors acceptable to Owner and Contractor and shall deliver such bids to Owner, who will then determine, with the advice of Engineer, which bids, if any, will be acceptable. If any subcontract provides that the Subcontractor is to be paid on the basis of Cost of the Work plus a fee, the Subcontractor's Cost of the Work and fee shall be determined in the same manner as Contractor's Cost of the Work and fee as provided in this Paragraph 13.01.
4. Costs of special consultants (including but not limited to engineers, architects, testing laboratories, surveyors, attorneys, and accountants) employed for services specifically related to the Work.
5. Supplemental costs including the following:
 - a. The proportion of necessary transportation, travel, and subsistence expenses of Contractor's employees incurred in discharge of duties connected with the Work.
 - b. Cost, including transportation and maintenance, of all materials, supplies, equipment, machinery, appliances, office, and temporary facilities at the Site, and hand tools not owned by the workers, which are consumed in the performance of the Work, and cost, less market value, of such items used but not consumed which remain the property of Contractor.
 - c. Rentals of all construction equipment and machinery, and the parts thereof, whether rented from Contractor or others in accordance with rental agreements approved by Owner with the advice of Engineer, and the costs of transportation, loading, unloading, assembly, dismantling, and removal thereof. All such costs shall be in accordance with the terms of said rental agreements. The rental of any such equipment, machinery, or parts shall cease when the use thereof is no longer necessary for the Work.
 - d. Sales, consumer, use, and other similar taxes related to the Work, and for which Contractor is liable, as imposed by Laws and Regulations.
 - e. Deposits lost for causes other than negligence of Contractor, any Subcontractor, or anyone directly or indirectly employed by any of them or for whose acts any of them may be liable, and royalty payments and fees for permits and licenses.
 - f. Losses and damages (and related expenses) caused by damage to the Work, not compensated by insurance or otherwise, sustained by Contractor in connection with the performance of the Work (except losses and damages within the deductible amounts of property insurance established in accordance with Paragraph 6.05), provided such losses and damages have resulted from causes other than the negligence of Contractor, any Subcontractor, or anyone directly or indirectly employed by any of them or for whose acts any of them may be liable. Such losses shall include settlements made with the written

consent and approval of Owner. No such losses, damages, and expenses shall be included in the Cost of the Work for the purpose of determining Contractor's fee.

- g. The cost of utilities, fuel, and sanitary facilities at the Site.
- h. Minor expenses such as communication service at the Site, express and courier services, and similar petty cash items in connection with the Work.
- i. The costs of premiums for all bonds and insurance that Contractor is required by the Contract Documents to purchase and maintain.

C. *Costs Excluded:* The term Cost of the Work shall not include any of the following items:

- 1. Payroll costs and other compensation of Contractor's officers, executives, principals (of partnerships and sole proprietorships), general managers, safety managers, engineers, architects, estimators, attorneys, auditors, accountants, purchasing and contracting agents, expeditors, timekeepers, clerks, and other personnel employed by Contractor, whether at the Site or in Contractor's principal or branch office for general administration of the Work and not specifically included in the agreed upon schedule of job classifications referred to in Paragraph 13.01.B.1 or specifically covered by Paragraph 13.01.B.4. The payroll costs and other compensation excluded here are to be considered administrative costs covered by the Contractor's fee.
- 2. Expenses of Contractor's principal and branch offices other than Contractor's office at the Site.
- 3. Any part of Contractor's capital expenses, including interest on Contractor's capital employed for the Work and charges against Contractor for delinquent payments.
- 4. Costs due to the negligence of Contractor, any Subcontractor, or anyone directly or indirectly employed by any of them or for whose acts any of them may be liable, including but not limited to, the correction of defective Work, disposal of materials or equipment wrongly supplied, and making good any damage to property.
- 5. Other overhead or general expense costs of any kind and the costs of any item not specifically and expressly included in Paragraph 13.01.B.

D. *Contractor's Fee:* When the Work as a whole is performed on the basis of cost-plus, Contractor's fee shall be determined as set forth in the Agreement. When the value of any Work covered by a Change Order, Change Proposal, Claim, set-off, or other adjustment in Contract Price is determined on the basis of Cost of the Work, Contractor's fee shall be determined as set forth in Paragraph 11.04.C.

E. *Documentation:* Whenever the Cost of the Work for any purpose is to be determined pursuant to this Article 13, Contractor will establish and maintain records thereof in accordance with generally accepted accounting practices and submit in a form acceptable to Engineer an itemized cost breakdown together with supporting data.

13.02 Allowances

- A. It is understood that Contractor has included in the Contract Price all allowances so named in the Contract Documents and shall cause the Work so covered to be performed for such sums and by such persons or entities as may be acceptable to Owner and Engineer.
- B. *Cash Allowances:* Contractor agrees that:
 - 1. the cash allowances include the cost to Contractor (less any applicable trade discounts) of materials and equipment required by the allowances to be delivered at the Site, and all applicable taxes; and

2. Contractor's costs for unloading and handling on the Site, labor, installation, overhead, profit, and other expenses contemplated for the cash allowances have been included in the Contract Price and not in the allowances, and no demand for additional payment on account of any of the foregoing will be valid.
- C. *Contingency Allowance*: Contractor agrees that a contingency allowance, if any, is for the sole use of Owner to cover unanticipated costs.
- D. Prior to final payment, an appropriate Change Order will be issued as recommended by Engineer to reflect actual amounts due Contractor on account of Work covered by allowances, and the Contract Price shall be correspondingly adjusted.

13.03 *Unit Price Work*

- A. Where the Contract Documents provide that all or part of the Work is to be Unit Price Work, initially the Contract Price will be deemed to include for all Unit Price Work an amount equal to the sum of the unit price for each separately identified item of Unit Price Work times the estimated quantity of each item as indicated in the Agreement.
- B. The estimated quantities of items of Unit Price Work are not guaranteed and are solely for the purpose of comparison of Bids and determining an initial Contract Price. Payments to Contractor for Unit Price Work will be based on actual quantities.
- C. Each unit price will be deemed to include an amount considered by Contractor to be adequate to cover Contractor's overhead and profit for each separately identified item.
- D. Engineer will determine the actual quantities and classifications of Unit Price Work performed by Contractor. Engineer will review with Contractor the Engineer's preliminary determinations on such matters before rendering a written decision thereon (by recommendation of an Application for Payment or otherwise). Engineer's written decision thereon will be final and binding (except as modified by Engineer to reflect changed factual conditions or more accurate data) upon Owner and Contractor, subject to the provisions of the following paragraph.
- E. Within 30 days of Engineer's written decision under the preceding paragraph, Contractor may submit a Change Proposal, or Owner may file a Claim, seeking an adjustment in the Contract Price if:
 1. the quantity of any item of Unit Price Work performed by Contractor differs materially and significantly from the estimated quantity of such item indicated in the Agreement;
 2. there is no corresponding adjustment with respect to any other item of Work; and
 3. Contractor believes that it is entitled to an increase in Contract Price as a result of having incurred additional expense or Owner believes that Owner is entitled to a decrease in Contract Price, and the parties are unable to agree as to the amount of any such increase or decrease.

ARTICLE 14 – TESTS AND INSPECTIONS; CORRECTION, REMOVAL OR ACCEPTANCE OF DEFECTIVE WORK

14.01 *Access to Work*

- A. Owner, Engineer, their consultants and other representatives and personnel of Owner, independent testing laboratories, and authorities having jurisdiction will have access to the Site and the Work at reasonable times for their observation, inspection, and testing. Contractor shall provide them proper and safe conditions for such access and advise them of Contractor's safety procedures and programs so that they may comply therewith as applicable.

14.02 *Tests, Inspections, and Approvals*

- A. Contractor shall give Engineer timely notice of readiness of the Work (or specific parts thereof) for all required inspections and tests, and shall cooperate with inspection and testing personnel to facilitate required inspections and tests.
- B. Owner shall retain and pay for the services of an independent inspector, testing laboratory, or other qualified individual or entity to perform all inspections and tests expressly required by the Contract Documents to be furnished and paid for by Owner, except that costs incurred in connection with tests or inspections of covered Work shall be governed by the provisions of Paragraph 14.05.
- C. If Laws or Regulations of any public body having jurisdiction require any Work (or part thereof) specifically to be inspected, tested, or approved by an employee or other representative of such public body, Contractor shall assume full responsibility for arranging and obtaining such inspections, tests, or approvals, pay all costs in connection therewith, and furnish Engineer the required certificates of inspection or approval.
- D. Contractor shall be responsible for arranging, obtaining, and paying for all inspections and tests required:
 - 1. by the Contract Documents, unless the Contract Documents expressly allocate responsibility for a specific inspection or test to Owner;
 - 2. to attain Owner's and Engineer's acceptance of materials or equipment to be incorporated in the Work;
 - 3. by manufacturers of equipment furnished under the Contract Documents;
 - 4. for testing, adjusting, and balancing of mechanical, electrical, and other equipment to be incorporated into the Work; and
 - 5. for acceptance of materials, mix designs, or equipment submitted for approval prior to Contractor's purchase thereof for incorporation in the Work.

Such inspections and tests shall be performed by independent inspectors, testing laboratories, or other qualified individuals or entities acceptable to Owner and Engineer.

- E. If the Contract Documents require the Work (or part thereof) to be approved by Owner, Engineer, or another designated individual or entity, then Contractor shall assume full responsibility for arranging and obtaining such approvals.
- F. If any Work (or the work of others) that is to be inspected, tested, or approved is covered by Contractor without written concurrence of Engineer, Contractor shall, if requested by Engineer, uncover such Work for observation. Such uncovering shall be at Contractor's expense unless Contractor had given Engineer timely notice of Contractor's intention to cover the same and Engineer had not acted with reasonable promptness in response to such notice.

14.03 *Defective Work*

- A. *Contractor's Obligation:* It is Contractor's obligation to assure that the Work is not defective.
- B. *Engineer's Authority:* Engineer has the authority to determine whether Work is defective, and to reject defective Work.
- C. *Notice of Defects:* Prompt notice of all defective Work of which Owner or Engineer has actual knowledge will be given to Contractor.
- D. *Correction, or Removal and Replacement:* Promptly after receipt of written notice of defective Work, Contractor shall correct all such defective Work, whether or not fabricated, installed, or

completed, or, if Engineer has rejected the defective Work, remove it from the Project and replace it with Work that is not defective.

- E. *Preservation of Warranties:* When correcting defective Work, Contractor shall take no action that would void or otherwise impair Owner's special warranty and guarantee, if any, on said Work.
- F. *Costs and Damages:* In addition to its correction, removal, and replacement obligations with respect to defective Work, Contractor shall pay all claims, costs, losses, and damages arising out of or relating to defective Work, including but not limited to the cost of the inspection, testing, correction, removal, replacement, or reconstruction of such defective Work, fines levied against Owner by governmental authorities because the Work is defective, and the costs of repair or replacement of work of others resulting from defective Work. Prior to final payment, if Owner and Contractor are unable to agree as to the measure of such claims, costs, losses, and damages resulting from defective Work, then Owner may impose a reasonable set-off against payments due under Article 15.

14.04 *Acceptance of Defective Work*

- A. If, instead of requiring correction or removal and replacement of defective Work, Owner prefers to accept it, Owner may do so (subject, if such acceptance occurs prior to final payment, to Engineer's confirmation that such acceptance is in general accord with the design intent and applicable engineering principles, and will not endanger public safety). Contractor shall pay all claims, costs, losses, and damages attributable to Owner's evaluation of and determination to accept such defective Work (such costs to be approved by Engineer as to reasonableness), and for the diminished value of the Work to the extent not otherwise paid by Contractor. If any such acceptance occurs prior to final payment, the necessary revisions in the Contract Documents with respect to the Work shall be incorporated in a Change Order. If the parties are unable to agree as to the decrease in the Contract Price, reflecting the diminished value of Work so accepted, then Owner may impose a reasonable set-off against payments due under Article 15. If the acceptance of defective Work occurs after final payment, Contractor shall pay an appropriate amount to Owner.

14.05 *Uncovering Work*

- A. Engineer has the authority to require additional inspection or testing of the Work, whether or not the Work is fabricated, installed, or completed.
- B. If any Work is covered contrary to the written request of Engineer, then Contractor shall, if requested by Engineer, uncover such Work for Engineer's observation, and then replace the covering, all at Contractor's expense.
- C. If Engineer considers it necessary or advisable that covered Work be observed by Engineer or inspected or tested by others, then Contractor, at Engineer's request, shall uncover, expose, or otherwise make available for observation, inspection, or testing as Engineer may require, that portion of the Work in question, and provide all necessary labor, material, and equipment.
 - 1. If it is found that the uncovered Work is defective, Contractor shall be responsible for all claims, costs, losses, and damages arising out of or relating to such uncovering, exposure, observation, inspection, and testing, and of satisfactory replacement or reconstruction (including but not limited to all costs of repair or replacement of work of others); and pending Contractor's full discharge of this responsibility the Owner shall be entitled to impose a reasonable set-off against payments due under Article 15.
 - 2. If the uncovered Work is not found to be defective, Contractor shall be allowed an increase in the Contract Price or an extension of the Contract Times, or both, directly attributable to such uncovering, exposure, observation, inspection, testing, replacement, and reconstruction. If the

parties are unable to agree as to the amount or extent thereof, then Contractor may submit a Change Proposal within 30 days of the determination that the Work is not defective.

14.06 *Owner May Stop the Work*

- A. If the Work is defective, or Contractor fails to supply sufficient skilled workers or suitable materials or equipment, or fails to perform the Work in such a way that the completed Work will conform to the Contract Documents, then Owner may order Contractor to stop the Work, or any portion thereof, until the cause for such order has been eliminated; however, this right of Owner to stop the Work shall not give rise to any duty on the part of Owner to exercise this right for the benefit of Contractor, any Subcontractor, any Supplier, any other individual or entity, or any surety for, or employee or agent of any of them.

14.07 *Owner May Correct Defective Work*

- A. If Contractor fails within a reasonable time after written notice from Engineer to correct defective Work, or to remove and replace rejected Work as required by Engineer, or if Contractor fails to perform the Work in accordance with the Contract Documents, or if Contractor fails to comply with any other provision of the Contract Documents, then Owner may, after seven days written notice to Contractor, correct or remedy any such deficiency.
- B. In exercising the rights and remedies under this Paragraph 14.07, Owner shall proceed expeditiously. In connection with such corrective or remedial action, Owner may exclude Contractor from all or part of the Site, take possession of all or part of the Work and suspend Contractor's services related thereto, and incorporate in the Work all materials and equipment stored at the Site or for which Owner has paid Contractor but which are stored elsewhere. Contractor shall allow Owner, Owner's representatives, agents and employees, Owner's other contractors, and Engineer and Engineer's consultants access to the Site to enable Owner to exercise the rights and remedies under this paragraph.
- C. All claims, costs, losses, and damages incurred or sustained by Owner in exercising the rights and remedies under this Paragraph 14.07 will be charged against Contractor as set-offs against payments due under Article 15. Such claims, costs, losses and damages will include but not be limited to all costs of repair, or replacement of work of others destroyed or damaged by correction, removal, or replacement of Contractor's defective Work.
- D. Contractor shall not be allowed an extension of the Contract Times because of any delay in the performance of the Work attributable to the exercise by Owner of Owner's rights and remedies under this Paragraph 14.07.

ARTICLE 15 – PAYMENTS TO CONTRACTOR; SET-OFFS; COMPLETION; CORRECTION PERIOD

15.01 *Progress Payments*

- A. *Basis for Progress Payments:* The Schedule of Values established as provided in Article 2 will serve as the basis for progress payments and will be incorporated into a form of Application for Payment acceptable to Engineer. Progress payments on account of Unit Price Work will be based on the number of units completed during the pay period, as determined under the provisions of Paragraph 13.03. Progress payments for cost-based Work will be based on Cost of the Work completed by Contractor during the pay period.
- B. *Applications for Payments:*
 - 1. At least 20 days before the date established in the Agreement for each progress payment (but not more often than once a month), Contractor shall submit to Engineer for review an Application for Payment filled out and signed by Contractor covering the Work completed as of

the date of the Application and accompanied by such supporting documentation as is required by the Contract Documents. If payment is requested on the basis of materials and equipment not incorporated in the Work but delivered and suitably stored at the Site or at another location agreed to in writing, the Application for Payment shall also be accompanied by a bill of sale, invoice, or other documentation warranting that Owner has received the materials and equipment free and clear of all Liens, and evidence that the materials and equipment are covered by appropriate property insurance, a warehouse bond, or other arrangements to protect Owner's interest therein, all of which must be satisfactory to Owner.

2. Beginning with the second Application for Payment, each Application shall include an affidavit of Contractor stating that all previous progress payments received on account of the Work have been applied on account to discharge Contractor's legitimate obligations associated with prior Applications for Payment.
3. The amount of retainage with respect to progress payments will be as stipulated in the Agreement.

C. *Review of Applications:*

1. Engineer will, within 10 days after receipt of each Application for Payment, including each resubmittal, either indicate in writing a recommendation of payment and present the Application to Owner, or return the Application to Contractor indicating in writing Engineer's reasons for refusing to recommend payment. In the latter case, Contractor may make the necessary corrections and resubmit the Application.
2. Engineer's recommendation of any payment requested in an Application for Payment will constitute a representation by Engineer to Owner, based on Engineer's observations of the executed Work as an experienced and qualified design professional, and on Engineer's review of the Application for Payment and the accompanying data and schedules, that to the best of Engineer's knowledge, information and belief:
 - a. the Work has progressed to the point indicated;
 - b. the quality of the Work is generally in accordance with the Contract Documents (subject to an evaluation of the Work as a functioning whole prior to or upon Substantial Completion, the results of any subsequent tests called for in the Contract Documents, a final determination of quantities and classifications for Unit Price Work under Paragraph 13.03, and any other qualifications stated in the recommendation); and
 - c. the conditions precedent to Contractor's being entitled to such payment appear to have been fulfilled in so far as it is Engineer's responsibility to observe the Work.
3. By recommending any such payment Engineer will not thereby be deemed to have represented that:
 - a. inspections made to check the quality or the quantity of the Work as it has been performed have been exhaustive, extended to every aspect of the Work in progress, or involved detailed inspections of the Work beyond the responsibilities specifically assigned to Engineer in the Contract; or
 - b. there may not be other matters or issues between the parties that might entitle Contractor to be paid additionally by Owner or entitle Owner to withhold payment to Contractor.
4. Neither Engineer's review of Contractor's Work for the purposes of recommending payments nor Engineer's recommendation of any payment, including final payment, will impose responsibility on Engineer:

- a. to supervise, direct, or control the Work, or
 - b. for the means, methods, techniques, sequences, or procedures of construction, or the safety precautions and programs incident thereto, or
 - c. for Contractor's failure to comply with Laws and Regulations applicable to Contractor's performance of the Work, or
 - d. to make any examination to ascertain how or for what purposes Contractor has used the money paid on account of the Contract Price, or
 - e. to determine that title to any of the Work, materials, or equipment has passed to Owner free and clear of any Liens.
5. Engineer may refuse to recommend the whole or any part of any payment if, in Engineer's opinion, it would be incorrect to make the representations to Owner stated in Paragraph 15.01.C.2.
6. Engineer will recommend reductions in payment (set-offs) necessary in Engineer's opinion to protect Owner from loss because:
- a. the Work is defective, requiring correction or replacement;
 - b. the Contract Price has been reduced by Change Orders;
 - c. Owner has been required to correct defective Work in accordance with Paragraph 14.07, or has accepted defective Work pursuant to Paragraph 14.04;
 - d. Owner has been required to remove or remediate a Hazardous Environmental Condition for which Contractor is responsible; or
 - e. Engineer has actual knowledge of the occurrence of any of the events that would constitute a default by Contractor and therefore justify termination for cause under the Contract Documents.
- D. *Payment Becomes Due:*
1. Ten days after presentation of the Application for Payment to Owner with Engineer's recommendation, the amount recommended (subject to any Owner set-offs) will become due, and when due will be paid by Owner to Contractor.
- E. *Reductions in Payment by Owner:*
1. In addition to any reductions in payment (set-offs) recommended by Engineer, Owner is entitled to impose a set-off against payment based on any of the following:
- a. claims have been made against Owner on account of Contractor's conduct in the performance or furnishing of the Work, or Owner has incurred costs, losses, or damages on account of Contractor's conduct in the performance or furnishing of the Work, including but not limited to claims, costs, losses, or damages from workplace injuries, adjacent property damage, non-compliance with Laws and Regulations, and patent infringement;
 - b. Contractor has failed to take reasonable and customary measures to avoid damage, delay, disruption, and interference with other work at or adjacent to the Site;
 - c. Contractor has failed to provide and maintain required bonds or insurance;
 - d. Owner has been required to remove or remediate a Hazardous Environmental Condition for which Contractor is responsible;

- e. Owner has incurred extra charges or engineering costs related to submittal reviews, evaluations of proposed substitutes, tests and inspections, or return visits to manufacturing or assembly facilities;
 - f. the Work is defective, requiring correction or replacement;
 - g. Owner has been required to correct defective Work in accordance with Paragraph 14.07, or has accepted defective Work pursuant to Paragraph 14.04;
 - h. the Contract Price has been reduced by Change Orders;
 - i. an event that would constitute a default by Contractor and therefore justify a termination for cause has occurred;
 - j. liquidated damages have accrued as a result of Contractor's failure to achieve Milestones, Substantial Completion, or final completion of the Work;
 - k. Liens have been filed in connection with the Work, except where Contractor has delivered a specific bond satisfactory to Owner to secure the satisfaction and discharge of such Liens;
 - l. there are other items entitling Owner to a set off against the amount recommended.
2. If Owner imposes any set-off against payment, whether based on its own knowledge or on the written recommendations of Engineer, Owner will give Contractor immediate written notice (with a copy to Engineer) stating the reasons for such action and the specific amount of the reduction, and promptly pay Contractor any amount remaining after deduction of the amount so withheld. Owner shall promptly pay Contractor the amount so withheld, or any adjustment thereto agreed to by Owner and Contractor, if Contractor remedies the reasons for such action. The reduction imposed shall be binding on Contractor unless it duly submits a Change Proposal contesting the reduction.
 3. Upon a subsequent determination that Owner's refusal of payment was not justified, the amount wrongfully withheld shall be treated as an amount due as determined by Paragraph 15.01.C.1 and subject to interest as provided in the Agreement.

15.02 *Contractor's Warranty of Title*

- A. Contractor warrants and guarantees that title to all Work, materials, and equipment furnished under the Contract will pass to Owner free and clear of (1) all Liens and other title defects, and (2) all patent, licensing, copyright, or royalty obligations, no later than seven days after the time of payment by Owner.

15.03 *Substantial Completion*

- A. When Contractor considers the entire Work ready for its intended use Contractor shall notify Owner and Engineer in writing that the entire Work is substantially complete and request that Engineer issue a certificate of Substantial Completion. Contractor shall at the same time submit to Owner and Engineer an initial draft of punch list items to be completed or corrected before final payment.
- B. Promptly after Contractor's notification, Owner, Contractor, and Engineer shall make an inspection of the Work to determine the status of completion. If Engineer does not consider the Work substantially complete, Engineer will notify Contractor in writing giving the reasons therefor.
- C. If Engineer considers the Work substantially complete, Engineer will deliver to Owner a preliminary certificate of Substantial Completion which shall fix the date of Substantial Completion. Engineer shall attach to the certificate a punch list of items to be completed or corrected before final payment. Owner shall have seven days after receipt of the preliminary certificate during which to

make written objection to Engineer as to any provisions of the certificate or attached punch list. If, after considering the objections to the provisions of the preliminary certificate, Engineer concludes that the Work is not substantially complete, Engineer will, within 14 days after submission of the preliminary certificate to Owner, notify Contractor in writing that the Work is not substantially complete, stating the reasons therefor. If Owner does not object to the provisions of the certificate, or if despite consideration of Owner's objections Engineer concludes that the Work is substantially complete, then Engineer will, within said 14 days, execute and deliver to Owner and Contractor a final certificate of Substantial Completion (with a revised punch list of items to be completed or corrected) reflecting such changes from the preliminary certificate as Engineer believes justified after consideration of any objections from Owner.

- D. At the time of receipt of the preliminary certificate of Substantial Completion, Owner and Contractor will confer regarding Owner's use or occupancy of the Work following Substantial Completion, review the builder's risk insurance policy with respect to the end of the builder's risk coverage, and confirm the transition to coverage of the Work under a permanent property insurance policy held by Owner. Unless Owner and Contractor agree otherwise in writing, Owner shall bear responsibility for security, operation, protection of the Work, property insurance, maintenance, heat, and utilities upon Owner's use or occupancy of the Work.
- E. After Substantial Completion the Contractor shall promptly begin work on the punch list of items to be completed or corrected prior to final payment. In appropriate cases Contractor may submit monthly Applications for Payment for completed punch list items, following the progress payment procedures set forth above.
- F. Owner shall have the right to exclude Contractor from the Site after the date of Substantial Completion subject to allowing Contractor reasonable access to remove its property and complete or correct items on the punch list.

15.04 *Partial Use or Occupancy*

- A. Prior to Substantial Completion of all the Work, Owner may use or occupy any substantially completed part of the Work which has specifically been identified in the Contract Documents, or which Owner, Engineer, and Contractor agree constitutes a separately functioning and usable part of the Work that can be used by Owner for its intended purpose without significant interference with Contractor's performance of the remainder of the Work, subject to the following conditions:
 - 1. At any time Owner may request in writing that Contractor permit Owner to use or occupy any such part of the Work that Owner believes to be substantially complete. If and when Contractor agrees that such part of the Work is substantially complete, Contractor, Owner, and Engineer will follow the procedures of Paragraph 15.03.A through E for that part of the Work.
 - 2. At any time Contractor may notify Owner and Engineer in writing that Contractor considers any such part of the Work substantially complete and request Engineer to issue a certificate of Substantial Completion for that part of the Work.
 - 3. Within a reasonable time after either such request, Owner, Contractor, and Engineer shall make an inspection of that part of the Work to determine its status of completion. If Engineer does not consider that part of the Work to be substantially complete, Engineer will notify Owner and Contractor in writing giving the reasons therefor. If Engineer considers that part of the Work to be substantially complete, the provisions of Paragraph 15.03 will apply with respect to certification of Substantial Completion of that part of the Work and the division of responsibility in respect thereof and access thereto.
 - 4. No use or occupancy or separate operation of part of the Work may occur prior to compliance with the requirements of Paragraph 6.05 regarding builder's risk or other property insurance.

15.05 *Final Inspection*

- A. Upon written notice from Contractor that the entire Work or an agreed portion thereof is complete, Engineer will promptly make a final inspection with Owner and Contractor and will notify Contractor in writing of all particulars in which this inspection reveals that the Work, or agreed portion thereof, is incomplete or defective. Contractor shall immediately take such measures as are necessary to complete such Work or remedy such deficiencies.

15.06 *Final Payment*

A. *Application for Payment:*

1. After Contractor has, in the opinion of Engineer, satisfactorily completed all corrections identified during the final inspection and has delivered, in accordance with the Contract Documents, all maintenance and operating instructions, schedules, guarantees, bonds, certificates or other evidence of insurance, certificates of inspection, annotated record documents (as provided in Paragraph 7.11), and other documents, Contractor may make application for final payment.
2. The final Application for Payment shall be accompanied (except as previously delivered) by:
 - a. all documentation called for in the Contract Documents;
 - b. consent of the surety, if any, to final payment;
 - c. satisfactory evidence that all title issues have been resolved such that title to all Work, materials, and equipment has passed to Owner free and clear of any Liens or other title defects, or will so pass upon final payment.
 - d. a list of all disputes that Contractor believes are unsettled; and
 - e. complete and legally effective releases or waivers (satisfactory to Owner) of all Lien rights arising out of the Work, and of Liens filed in connection with the Work.
3. In lieu of the releases or waivers of Liens specified in Paragraph 15.06.A.2 and as approved by Owner, Contractor may furnish receipts or releases in full and an affidavit of Contractor that: (a) the releases and receipts include all labor, services, material, and equipment for which a Lien could be filed; and (b) all payrolls, material and equipment bills, and other indebtedness connected with the Work for which Owner might in any way be responsible, or which might in any way result in liens or other burdens on Owner's property, have been paid or otherwise satisfied. If any Subcontractor or Supplier fails to furnish such a release or receipt in full, Contractor may furnish a bond or other collateral satisfactory to Owner to indemnify Owner against any Lien, or Owner at its option may issue joint checks payable to Contractor and specified Subcontractors and Suppliers.

B. *Engineer's Review of Application and Acceptance:*

1. If, on the basis of Engineer's observation of the Work during construction and final inspection, and Engineer's review of the final Application for Payment and accompanying documentation as required by the Contract Documents, Engineer is satisfied that the Work has been completed and Contractor's other obligations under the Contract have been fulfilled, Engineer will, within ten days after receipt of the final Application for Payment, indicate in writing Engineer's recommendation of final payment and present the Application for Payment to Owner for payment. Such recommendation shall account for any set-offs against payment that are necessary in Engineer's opinion to protect Owner from loss for the reasons stated above with respect to progress payments. At the same time Engineer will also give written notice to Owner and Contractor that the Work is acceptable, subject to the provisions of Paragraph 15.07. Otherwise, Engineer will return the Application for Payment to Contractor, indicating in

writing the reasons for refusing to recommend final payment, in which case Contractor shall make the necessary corrections and resubmit the Application for Payment.

- C. *Completion of Work*: The Work is complete (subject to surviving obligations) when it is ready for final payment as established by the Engineer's written recommendation of final payment.
- D. *Payment Becomes Due*: Thirty days after the presentation to Owner of the final Application for Payment and accompanying documentation, the amount recommended by Engineer (less any further sum Owner is entitled to set off against Engineer's recommendation, including but not limited to set-offs for liquidated damages and set-offs allowed under the provisions above with respect to progress payments) will become due and shall be paid by Owner to Contractor.

15.07 *Waiver of Claims*

- A. The making of final payment will not constitute a waiver by Owner of claims or rights against Contractor. Owner expressly reserves claims and rights arising from unsettled Liens, from defective Work appearing after final inspection pursuant to Paragraph 15.05, from Contractor's failure to comply with the Contract Documents or the terms of any special guarantees specified therein, from outstanding Claims by Owner, or from Contractor's continuing obligations under the Contract Documents.
- B. The acceptance of final payment by Contractor will constitute a waiver by Contractor of all claims and rights against Owner other than those pending matters that have been duly submitted or appealed under the provisions of Article 17.

15.08 *Correction Period*

- A. If within one year after the date of Substantial Completion (or such longer period of time as may be prescribed by the terms of any applicable special guarantee required by the Contract Documents, or by any specific provision of the Contract Documents), any Work is found to be defective, or if the repair of any damages to the Site, adjacent areas that Contractor has arranged to use through construction easements or otherwise, and other adjacent areas used by Contractor as permitted by Laws and Regulations, is found to be defective, then Contractor shall promptly, without cost to Owner and in accordance with Owner's written instructions:
 - 1. correct the defective repairs to the Site or such other adjacent areas;
 - 2. correct such defective Work;
 - 3. if the defective Work has been rejected by Owner, remove it from the Project and replace it with Work that is not defective, and
 - 4. satisfactorily correct or repair or remove and replace any damage to other Work, to the work of others, or to other land or areas resulting therefrom.
- B. If Contractor does not promptly comply with the terms of Owner's written instructions, or in an emergency where delay would cause serious risk of loss or damage, Owner may have the defective Work corrected or repaired or may have the rejected Work removed and replaced. Contractor shall pay all claims, costs, losses, and damages (including but not limited to all fees and charges of engineers, architects, attorneys, and other professionals and all court or arbitration or other dispute resolution costs) arising out of or relating to such correction or repair or such removal and replacement (including but not limited to all costs of repair or replacement of work of others).
- C. In special circumstances where a particular item of equipment is placed in continuous service before Substantial Completion of all the Work, the correction period for that item may start to run from an earlier date if so provided in the Specifications.

- D. Where defective Work (and damage to other Work resulting therefrom) has been corrected or removed and replaced under this paragraph, the correction period hereunder with respect to such Work will be extended for an additional period of one year after such correction or removal and replacement has been satisfactorily completed.
- E. Contractor's obligations under this paragraph are in addition to all other obligations and warranties. The provisions of this paragraph shall not be construed as a substitute for, or a waiver of, the provisions of any applicable statute of limitation or repose.

ARTICLE 16 – SUSPENSION OF WORK AND TERMINATION

16.01 *Owner May Suspend Work*

- A. At any time and without cause, Owner may suspend the Work or any portion thereof for a period of not more than 90 consecutive days by written notice to Contractor and Engineer. Such notice will fix the date on which Work will be resumed. Contractor shall resume the Work on the date so fixed. Contractor shall be entitled to an adjustment in the Contract Price or an extension of the Contract Times, or both, directly attributable to any such suspension. Any Change Proposal seeking such adjustments shall be submitted no later than 30 days after the date fixed for resumption of Work.

16.02 *Owner May Terminate for Cause*

- A. The occurrence of any one or more of the following events will constitute a default by Contractor and justify termination for cause:
 - 1. Contractor's persistent failure to perform the Work in accordance with the Contract Documents (including, but not limited to, failure to supply sufficient skilled workers or suitable materials or equipment or failure to adhere to the Progress Schedule);
 - 2. Failure of Contractor to perform or otherwise to comply with a material term of the Contract Documents;
 - 3. Contractor's disregard of Laws or Regulations of any public body having jurisdiction; or
 - 4. Contractor's repeated disregard of the authority of Owner or Engineer.
- B. If one or more of the events identified in Paragraph 16.02.A occurs, then after giving Contractor (and any surety) ten days written notice that Owner is considering a declaration that Contractor is in default and termination of the contract, Owner may proceed to:
 - 1. declare Contractor to be in default, and give Contractor (and any surety) notice that the Contract is terminated; and
 - 2. enforce the rights available to Owner under any applicable performance bond.
- C. Subject to the terms and operation of any applicable performance bond, if Owner has terminated the Contract for cause, Owner may exclude Contractor from the Site, take possession of the Work, incorporate in the Work all materials and equipment stored at the Site or for which Owner has paid Contractor but which are stored elsewhere, and complete the Work as Owner may deem expedient.
- D. Owner may not proceed with termination of the Contract under Paragraph 16.02.B if Contractor within seven days of receipt of notice of intent to terminate begins to correct its failure to perform and proceeds diligently to cure such failure.
- E. If Owner proceeds as provided in Paragraph 16.02.B, Contractor shall not be entitled to receive any further payment until the Work is completed. If the unpaid balance of the Contract Price exceeds the cost to complete the Work, including all related claims, costs, losses, and damages (including but not limited to all fees and charges of engineers, architects, attorneys, and other professionals)

sustained by Owner, such excess will be paid to Contractor. If the cost to complete the Work including such related claims, costs, losses, and damages exceeds such unpaid balance, Contractor shall pay the difference to Owner. Such claims, costs, losses, and damages incurred by Owner will be reviewed by Engineer as to their reasonableness and, when so approved by Engineer, incorporated in a Change Order. When exercising any rights or remedies under this paragraph, Owner shall not be required to obtain the lowest price for the Work performed.

- F. Where Contractor's services have been so terminated by Owner, the termination will not affect any rights or remedies of Owner against Contractor then existing or which may thereafter accrue, or any rights or remedies of Owner against Contractor or any surety under any payment bond or performance bond. Any retention or payment of money due Contractor by Owner will not release Contractor from liability.
- G. If and to the extent that Contractor has provided a performance bond under the provisions of Paragraph 6.01.A, the provisions of that bond shall govern over any inconsistent provisions of Paragraphs 16.02.B and 16.02.D.

16.03 *Owner May Terminate For Convenience*

- A. Upon seven days written notice to Contractor and Engineer, Owner may, without cause and without prejudice to any other right or remedy of Owner, terminate the Contract. In such case, Contractor shall be paid for (without duplication of any items):
 - 1. completed and acceptable Work executed in accordance with the Contract Documents prior to the effective date of termination, including fair and reasonable sums for overhead and profit on such Work;
 - 2. expenses sustained prior to the effective date of termination in performing services and furnishing labor, materials, or equipment as required by the Contract Documents in connection with uncompleted Work, plus fair and reasonable sums for overhead and profit on such expenses; and
 - 3. other reasonable expenses directly attributable to termination, including costs incurred to prepare a termination for convenience cost proposal.
- B. Contractor shall not be paid on account of loss of anticipated overhead, profits, or revenue, or other economic loss arising out of or resulting from such termination.

16.04 *Contractor May Stop Work or Terminate*

- A. If, through no act or fault of Contractor, (1) the Work is suspended for more than 90 consecutive days by Owner or under an order of court or other public authority, or (2) Engineer fails to act on any Application for Payment within 30 days after it is submitted, or (3) Owner fails for 30 days to pay Contractor any sum finally determined to be due, then Contractor may, upon seven days written notice to Owner and Engineer, and provided Owner or Engineer do not remedy such suspension or failure within that time, terminate the contract and recover from Owner payment on the same terms as provided in Paragraph 16.03.
- B. In lieu of terminating the Contract and without prejudice to any other right or remedy, if Engineer has failed to act on an Application for Payment within 30 days after it is submitted, or Owner has failed for 30 days to pay Contractor any sum finally determined to be due, Contractor may, seven days after written notice to Owner and Engineer, stop the Work until payment is made of all such amounts due Contractor, including interest thereon. The provisions of this paragraph are not intended to preclude Contractor from submitting a Change Proposal for an adjustment in Contract Price or Contract Times or otherwise for expenses or damage directly attributable to Contractor's stopping the Work as permitted by this paragraph.

ARTICLE 17 – FINAL RESOLUTION OF DISPUTES

17.01 *Methods and Procedures*

- A. *Disputes Subject to Final Resolution:* The following disputed matters are subject to final resolution under the provisions of this Article:
 - 1. A timely appeal of an approval in part and denial in part of a Claim, or of a denial in full; and
 - 2. Disputes between Owner and Contractor concerning the Work or obligations under the Contract Documents, and arising after final payment has been made.
- B. *Final Resolution of Disputes:* For any dispute subject to resolution under this Article, Owner or Contractor may:
 - 1. elect in writing to invoke the dispute resolution process provided for in the Supplementary Conditions; or
 - 2. agree with the other party to submit the dispute to another dispute resolution process; or
 - 3. if no dispute resolution process is provided for in the Supplementary Conditions or mutually agreed to, give written notice to the other party of the intent to submit the dispute to a court of competent jurisdiction.

ARTICLE 18 – MISCELLANEOUS

18.01 *Giving Notice*

- A. Whenever any provision of the Contract Documents requires the giving of written notice, it will be deemed to have been validly given if:
 - 1. delivered in person, by a commercial courier service or otherwise, to the individual or to a member of the firm or to an officer of the corporation for which it is intended; or
 - 2. delivered at or sent by registered or certified mail, postage prepaid, to the last business address known to the sender of the notice.

18.02 *Computation of Times*

- A. When any period of time is referred to in the Contract by days, it will be computed to exclude the first and include the last day of such period. If the last day of any such period falls on a Saturday or Sunday or on a day made a legal holiday by the law of the applicable jurisdiction, such day will be omitted from the computation.

18.03 *Cumulative Remedies*

- A. The duties and obligations imposed by these General Conditions and the rights and remedies available hereunder to the parties hereto are in addition to, and are not to be construed in any way as a limitation of, any rights and remedies available to any or all of them which are otherwise imposed or available by Laws or Regulations, by special warranty or guarantee, or by other provisions of the Contract. The provisions of this paragraph will be as effective as if repeated specifically in the Contract Documents in connection with each particular duty, obligation, right, and remedy to which they apply.

18.04 *Limitation of Damages*

- A. With respect to any and all Change Proposals, Claims, disputes subject to final resolution, and other matters at issue, neither Owner nor Engineer, nor any of their officers, directors, members, partners, employees, agents, consultants, or subcontractors, shall be liable to Contractor for any

claims, costs, losses, or damages sustained by Contractor on or in connection with any other project or anticipated project.

18.05 *No Waiver*

- A. A party's non-enforcement of any provision shall not constitute a waiver of that provision, nor shall it affect the enforceability of that provision or of the remainder of this Contract.

18.06 *Survival of Obligations*

- A. All representations, indemnifications, warranties, and guarantees made in, required by, or given in accordance with the Contract, as well as all continuing obligations indicated in the Contract, will survive final payment, completion, and acceptance of the Work or termination or completion of the Contract or termination of the services of Contractor.

18.07 *Controlling Law*

- A. This Contract is to be governed by the law of the state in which the Project is located.

18.08 *Headings*

- A. Article and paragraph headings are inserted for convenience only and do not constitute parts of these General Conditions.

Certificate of Owner's Attorney & Agency Concurrence

CERTIFICATE OF OWNER'S ATTORNEY

PROJECT NAME: Novelis Sanitary Sewer Project: Contract No. 1 – Gravity Sewer

CONTRACTOR NAME: _____

I, the undersigned, Jeff Traughber, the duly authorized and acting legal representative of the City of Guthrie, do hereby certify as follows:

I have examined the attached Contract(s) and performance and payment bond(s) and the manner of execution thereof, and I am of the opinion that each of the aforesaid agreements is adequate and has been duly executed by the proper parties thereto acting through their duly authorized representatives; that said representatives have full power and authority to execute said agreements on behalf of the respective parties named thereon; and that the foregoing agreements constitute valid and legally binding obligations upon the parties executing the same in accordance with the terms, conditions, and provisions thereof.

Name

Date: _____

AGENCY CONCURRENCE:

As lender or insurer of funds to defray the costs of this Contract, and without liability for any payments thereunder, the Agency hereby concurs in the form, content, and execution of this Agreement.

Agency: _____

By: _____

Date: _____

Title: _____

Supplementary Conditions

A. These Supplementary Conditions amend or supplement the Standard General Conditions of the Construction Contract, EJCDC® C-700 (2013 Edition). All provisions that are not so amended or supplemented remain in full force and effect.

B. The terms used in these Supplementary Conditions have the meanings stated in the General Conditions. Additional terms used in these Supplementary Conditions have the meanings stated below, which are applicable to both the singular and plural thereof.

C. The address system used in these Supplementary Conditions is the same as the address system used in the General Conditions, with the prefix "SC" added thereto.

D. Table of Contents

| | |
|---|----|
| SC-1.01. Defined Terms | 2 |
| SC-2.01 Delivery of Bonds and Evidence of Insurance..... | 3 |
| SC-2.02 Copies of Documents | 3 |
| SC-2.03 Before Starting Construction..... | 3 |
| SC-2.05 Initial Acceptance of Schedules | 3 |
| SC-3.03 Reporting Discrepancies..... | 3 |
| SC-3.04 Requirements of the Contract Documents | 4 |
| SC-4.01 Commencement of Contract Times; Notice to Proceed | 4 |
| SC-4.03 Reference Points | 4 |
| SC-5.03 Subsurface and Physical Conditions..... | 4 |
| SC-5.05 Underground Facilities..... | 4 |
| SC-5.06 Hazardous Environmental Conditions..... | 4 |
| SC-6.01 Performance and Payment Bonds | 5 |
| SC-6.03 Contractor's Insurance..... | 5 |
| SC-6.05 Property Insurance | 7 |
| SC-7.02.B Labor; Working Hours | 8 |
| SC-7.03.B Services, Materials and Equipment | 8 |
| SC-7.04 "Or Equals" | 8 |
| SC-7.05 Submittals | 9 |
| SC-7.06 Concerning Subcontractors, Suppliers, & Others | 9 |
| SC-7.08 Permits | 9 |
| SC-7.10 Laws and Regulations | 9 |
| SC-7.11 Record Documents..... | 10 |
| SC-7.13 Competent Person..... | 10 |
| SC-7.16 Shop Drawings | 10 |
| SC-7.17 Contractor's General Warranty and Guarantee | 10 |
| SC-7.18 Indemnification | 10 |
| SC-7.19 Delegation of Professional Design Services | 11 |
| SC-10.03 Project Representative | 11 |
| SC-10.10 American Iron & Steel | 14 |
| SC-11.01 Amending the Contract Documents; Changes in the Work | 14 |
| SC-11.02 Owner-Authorized Changes in the Work..... | 14 |
| SC-11.04 Change of Contract Price..... | 14 |
| SC-11.06 Change Proposals | 15 |
| SC-11.07 Execution of Change Orders..... | 15 |
| SC-11.08 Notification to Surety..... | 15 |
| SC-12.01.A Claims Process | 15 |
| SC-13.02 Allowances | 16 |

| | |
|---|----|
| SC-13.03 Unit Price Work..... | 16 |
| SC-14.02.A Tests and Inspections | 16 |
| SC-14.03 Defective Work | 16 |
| SC-15.01 Progress Payments | 17 |
| SC-15.02 Contractor's Warranty of Title | 17 |
| SC-15.04 Partial Utilization..... | 17 |
| SC-15.08.A Correction Period | 18 |
| SC-16.02 Owner May Terminate for Cause | 18 |
| SC-16.03 Owner May Terminate for Convenience..... | 18 |
| SC-18 Miscellaneous | 18 |
| SC-19 Federal Requirements (New) | 19 |

SC-1.01 Defined Terms

SC 1.01.A.3 Add the following language at the end of last sentence of Paragraph 1.01.A.3:

The Application for Payment form to be used on this project is RD Form 1927-7.

SC 1.01.A.8 Insert a comma and the word “Engineer” immediately after the word “Contractor” in this definition.

SC 1.01.A.8 Add the following language at the end of last sentence of Paragraph 1.01.A.8:
The Change Order form to be used on this Project is EJCDC C-941. Agency approval is required before Change Orders are effective.

SC 1.01.A.48 Add the following language at the end of the last sentence of Paragraph 1.01.A.48:
A Work Change Directive cannot change Contract Price or Contract Times without a subsequent Change Order.

SC 1.01.A.49 Add the following new Paragraph after Paragraph 1.01.A.48:
Abnormal Weather Conditions – Conditions of extreme or unusual weather for a given region, elevation, or season as determined by Engineer. Extreme or unusual weather that is typical for a given region, elevation, or season should not be considered Abnormal Weather Conditions.

SC 1.01.A.50 Add the following new Paragraph after Paragraph 1.01.A.49:
Agency - The Project is financed in whole or in part by USDA Rural Utilities Service pursuant to the Consolidated Farm and Rural Development Act (7 USC Section 1921 et seq.). The Rural Utilities Service programs are administered through the USDA Rural Development offices; therefore, the Agency for these documents is USDA Rural Development.

SC 1.01.A.51 Add the following new Paragraph after Paragraph 1.01.A.50:
Manufacturer’s Certification letter is documentation provided by the manufacturer, supplier, distributor, vendor, fabricator, etc. to various entities stating that the American Iron and Steel products to be used in the project are produced in the United States in accordance with American Iron and Steel requirements. Refer to Manufacturer’s Certification Letter provided in these Contract Documents.

SC 1.01.A.52 Add the following new Paragraph after Paragraph 1.01.A.51:
AIS - refers to requirements mandated by Section 746 of Title VII of the Consolidated Appropriations Act of 2017 (Division A - Agriculture, Rural Development, Food and Drug Administration, and Related Agencies Appropriations Act, 2017) and subsequent statutes mandating domestic preference. The term “iron and steel products” means the following products made primarily of iron or steel: lined or unlined pipes and fittings, manhole covers and

other municipal castings, hydrants, tanks, flanges, pipe clamps and restraints, valves, structural steel, reinforced precast concrete, and construction materials.

SC-2.01 Delivery of Bonds and Evidence of Insurance

Delete Paragraphs 2.01 B. and C. in their entirety and insert the following in their place:

B. Evidence of Contractor's Insurance: When Contractor delivers the executed counterparts of the Agreement to Owner, Contractor shall also deliver to Owner copies of the policies of insurance (including all endorsements, and identification of applicable self-insured retentions and deductibles) required to be provided by Contractor in Article 6. Contractor may block out (redact) any confidential premium or pricing information contained in any policy or endorsement furnished under this provision.

SC-2.02 Copies of Documents

Amend the first sentence of Paragraph 2.02.A. to read as follows:

Owner shall furnish the Contractor up to five copies of the Contract Documents (including one fully executed counterpart of the Agreement), and one copy in electronic portable document format (PDF).

SC-2.03 Before Starting Construction

Add the following subparagraph to Paragraph 2.03:

4. a proposed listing of subcontractors and major material and equipment suppliers. The list shall include any proposed substitutions in accordance with Paragraph 7.05.

SC-2.05 Initial Acceptance of Schedules

Add the following language to the end of Paragraph 2.05.A.2:

The schedule for shop drawings shall show all submittals complete before 25% of completion of the Work and the schedule for maintenance manuals shall show all submittals complete before 50% of completion of the Work.

Add the following language to the end of Paragraph 2.05.A.3:

The Bid will be considered the Schedule of Values of the Work required by the General Conditions.

SC-3.03 Reporting Discrepancies

Add the following language at the end of Paragraph 3.03.A:

4. Contractor shall report apparent discrepancies to Engineer using a Request for Information form on a form supplied by Engineer. The Request for Information form shall:

- a. be submitted by Contractor only;
- b. be legible and complete;
- c. not be used for the purposes of only confirming or verifying issues; and,
- d. be prioritized by Contractor in the event that multiple Requests for Information are outstanding.

Requests for Information that are not in conformance with the requirements above shall be returned to Contractor without response.

5. Contractor shall not be relieved of its responsibility to coordinate the Work to prevent adverse impacts to Contractor's Project Schedule while submitting Requests for Information.

6. If Contractor believes the Scope of Work included in the Request for Information has a cost and/or time impact, Contractor should submit a claim in accordance with Article 12 of these General Conditions.

7. If Contractor proceeds with work when Contractor had actual knowledge or should have known that a conflict, error, ambiguity, or discrepancy existed as indicated above, correction of work constructed without such notification to Engineer shall be at Contractor's expense, (except in an emergency as authorized by Paragraph 7.15.A).

SC-3.04 Requirements of the Contract Documents

Delete Paragraph 3.04.C in its entirety.

SC-4.01 Commencement of Contract Times; Notice to Proceed

SC 4.01.A Amend the last sentence of Paragraph 4.01.A by striking out the following words: In no event will the Contract Times commence to run later than the ninetieth day after the day of Bid opening or the thirtieth day after the Effective Date of the Contract, whichever date is earlier.

SC-4.03 Reference Points

Add the following new paragraph immediately after Paragraph 4.03.A:

B. CONTRACTOR is referred to the General Requirements for additional requirements for laying out the work.

SC-5.03 Subsurface and Physical Conditions

Delete Paragraphs 5.03.A and 5.03.B in their entirety and insert the following:

A. No reports of explorations or tests of subsurface conditions at or adjacent to the Site, or drawings of physical conditions relating to existing surface or subsurface structures at the Site, are known to Owner.

SC-5.05 Underground Facilities

Add the following paragraph immediately after Paragraph 5.05.E:

F. Contractor is referred to the General Requirements for requirements for keeping records of Underground Facilities and allowing facility owners to inspect.

SC-5.06 Hazardous Environmental Conditions

Delete Paragraphs 5.06.A and 5.06.B in their entirety and insert the following:

A. No reports or drawings related to Hazardous Environmental Conditions at the Site are known to Owner.

B. Not Used.

SC-6.01 Performance and Payment Bonds

Add the following new paragraphs immediately after Paragraph 6.01.F:

G. The forms of the performance and payment Bonds attached hereto shall be used for the Contract. Note instructions thereon as to the form applicable. Each form contemplates one corporate surety only. In case co-sureties or individual sureties will be furnished, proper forms therefore shall be obtained. Besides the stipulations of Paragraphs 6.01 through 6.03, the surety on the Bonds shall provide a certificate indicating surety is licensed to underwrite contracts in the jurisdiction of the project location which shall be attached to the Bonds.

H. Every Bond must run to Owner.

I. If the principal is an individual, his/her full name and residence shall be inserted in the body thereof, and he/she shall sign the Bonds with his/her usual signature on the line opposite the scroll seal. If the principals are partners, their individual names shall appear in the body of the Bonds, with the recital that they are partners comprising a firm, naming it, and all the members of the firm shall execute the Bonds as individuals.

J. The signature of a witness shall appear in the appropriate places, attesting the signatures of each individual party to the Bonds.

K. If the principal is a corporation, the name of the state in which incorporated shall be inserted in the appropriate place in the body of the Bonds, and said instrument shall be executed and attested under the corporate seal as indicated on the form. If the corporation has no seal, the fact shall be stated, in which case a scroll or adhesive seal shall appear following the corporate name. This also applies to execution by surety.

L. The date of the Bonds must not be prior to the date of the Contract for which given.

M. The bond shall be signed by an individual authorized to sign on behalf of the surety and a power of attorney, authorizing the execution of the Bonds by an attorney-in-fact, or agent of the surety, shall be attached to one executed counterpart of the Bonds.

SC-6.03 Contractor's Insurance

Add the following to the end of Paragraph 6.03.C.7:

All additional insureds shall be endorsed on the policy as required in Paragraph 6.03.C.7. Endorsements shall not exclude supervisory or inspection services.

Delete Paragraph 6.03.C.8 in its entirety and add the following new paragraphs immediately after Paragraph 6.03.C.7:

8. Railroad Protective Liability Policy: Not applicable. Owner secured.

a. CONTRACTOR shall provide a Railroad Protective Liability Policy for bodily injury, property damage liability, and physical damage to property liability, per limits, duration, and conditions noted in the documents provided by the Railroad bound at the end of Division 1.

9. The types of insurance and the limits of liability indicated are the minimum required. Neither Owner nor Engineer warrant the adequacy of the types of insurance or the limits of liability required. Any policy exclusions shall be indicated on the insurance certificate. Contractor shall provide verification of all coverages with or on the insurance certificate.

10. Regardless whether or not an Owners' and Contractors' Protective (OCP) policy or Project Management Protective Liability (PMPL) policy is furnished, insurance certificates for commercial general, automobile, umbrella, and builders risk shall specifically indicate by name the additional insureds which are to include Owner and Engineer as well as other persons or entities so identified. Certificates shall be Acord 25-S or equivalent.

11. As an alternative to providing Form CG 20 10 10 01 or CG 20 10 07 04, Contractor may furnish to Owner an OCP policy or a PMPL policy with Owner as the named insured and Engineer as either an additional insured or a named insured. OCP policy or PMPL policy shall provide for bodily injury and property damage coverage equal to the sum of: the general aggregate limit for commercial general liability plus the amount specified for the umbrella coverage. OCP policy or PMPL policy shall provide coverage arising out of:

- a. operations performed by Contractor at the project location.
- b. acts or omissions in connection with the general supervision, inspection and/or coordination of such operations.

If an OCP or PMPL policy is provided, Contractor shall provide originals of the Final OCP or PMPL to all insured and additional insured parties.

12. Endorsements, OCP policy, PMPL policy, or General Liability policy shall not exclude supervisory or inspection services.

13. Contractor shall also provide an Additional Insured Endorsement for the automobile policy. Endorsement form shall be CA 20 48, or equal.

Change in Paragraph 6.03.I.3 the phrase "materially changed" to read "materially changed with respect to coverage on the project."

Delete Paragraph 6.03.J in its entirety and insert the following new paragraph in its place:

J. The stated limits of Paragraphs 6.03.K.1, 6.03.K.2, and 6.03.K.3 can be obtained through individual policies or in conjunction with an umbrella policy (pay on behalf form) to arrive at the total limits requested.

Add the following new paragraph immediately after Paragraph 6.03.J:

K. The limits of liability for the insurance required by Paragraph 6.03 of the General Conditions shall provide coverage for not less than the following amounts or greater where required by Laws and Regulations:

- 1. Workers' Compensation, and related coverages under Paragraphs 6.03.A.1 and A.2 of the General Conditions:

State: Statutory

Federal, if applicable (e.g., Longshoreman's): Statutory

Foreign voluntary worker compensation Statutory

- 2. Contractor's Commercial General Liability under Paragraphs 6.03.B and 6.03.C of the General Conditions:

General Aggregate \$ 5,000,000

| | | |
|---|----|------------------|
| Products - Completed Operations Aggregate | \$ | <u>5,000,000</u> |
| Personal and Advertising Injury | \$ | <u>1,000,000</u> |
| Each Occurrence (Bodily Injury and Property Damage) | \$ | <u>1,000,000</u> |

General Aggregate Limits specified above shall apply separately to this project by attachment of:

“Amendment of Limits of Insurance—Designated Location(s) General Aggregate Limit Endorsement (ISO Form No. CG 25040509) or “Designated Construction Project(s) General Aggregate Limit” Endorsement (ISO Form CG 25030509) or equivalent endorsement coverage.

3. Automobile Liability under Paragraph 6.03.D. of the General Conditions:

| | | |
|--------------------------|----|------------------|
| Combined Single Limit of | \$ | <u>1,000,000</u> |
|--------------------------|----|------------------|

4. Excess or Umbrella Liability:

| | | |
|-------------------|----|------------------|
| Per Occurrence | \$ | <u>1,000,000</u> |
| General Aggregate | \$ | <u>1,000,000</u> |

5. Contractor’s Pollution Liability:

| | | |
|-------------------|----|-----------------------------|
| Each Occurrence | \$ | <u> </u> |
| General Aggregate | \$ | <u> </u> |

If box is checked, Contractor is not required to provide Contractor’s Pollution Liability insurance under this Contract

6. Additional Insureds: In addition to Owner and Engineer, include as additional insureds the following: none.

SC-6.05 Property Insurance

Delete from the first sentence of Paragraph 6.05.A.2, the phrase “All-risk” policy form and insert the following in its place:

“Cause of Loss-Special Form”

Delete from the first sentence of Paragraph 6.05.A.2, the phrase “(other than caused by flood)” and insert the following in its place:

“(including that caused by flood and hydrostatic pressure)”

Delete Paragraph 6.05.A.10 and insert the following in its place:

10. Not used.

Delete Paragraph 6.05.A.12 and insert the following in its place:

12. Not used.

Add the following to the list of items in Paragraph 6.05.A, as numbered items:

14. include for the benefit of Owner loss of profits and soft cost coverage including, without limitation, fixed expenses and debt service for a minimum of 12 months with a maximum deductible of 30 days, plus attorneys fees and engineering or other consultants' fees, if not otherwise covered;

SC-7.02.B Labor; Working Hours

Amend the first and second sentences of Paragraph 7.02.B to state "...all Work at the Site shall be performed during regular daylight working hours, 7:00 am through 5:00 pm. Contractor will not perform Work on a Saturday, Sunday or any legal holiday unless approved by the Engineer."

SC-7.03 Services, Materials and Equipment

Add the following to the end of Paragraph 7.03.B:

Suppliers shall be deemed to impliedly warrant that their products and all component materials incorporated into them are suitable and fit for the intended use of such products and shall be free from defect in material, workmanship or design, such warranty to run to the benefit of Owner and Engineer. The foregoing applies whether the products or their component materials are specified in the Contract Documents or are of Supplier's design.

Add the following new Paragraph 7.03.D:

All iron and steel products must meet American Iron and Steel requirements.

SC-7.04 "Or Equals"

SC 7.04.A Amend the third sentence of Paragraph 7.04.A by striking out the following words:

Unless the specification or description contains or is followed by words reading that no like, equivalent, or 'or-equal' item is permitted.

SC 7.04.A.1 Amend the last sentence of Paragraph a.3 by striking out "and;" and adding a period at the end of Paragraph a.3.

SC 7.04.A.1 Delete paragraph 7.04.A.1.a.4 in its entirety and insert "Deleted" in its place.

SC 7.04.B.1 Add paragraph 7.04.B.1.in its entirety:

Contractor shall include a Manufacturer's Certification letter for compliance with American Iron and Steel requirements in support data, if applicable. In addition, Contractor shall maintain an updated AIS Materials List to ensure that for de minimis waiver, cost is less than 5% of total materials cost for project and for minor components waiver, the cost of the non-domestically produced component is less than 5% of the total materials cost of the project. An excel version that will compute all totals can be obtained from the RD state office that can be used as working copy.

SC-7.05 Substitutes

SC 7.05.A.3.a.4 Add paragraph 7.05.A.3.a.4 in its entirety:

- 4) comply with American Iron and Steel by providing Manufacturer's Certification letter of American Iron and Steel compliance, if applicable. Refer to Manufacturer's Certification Letter provided in these Contract Documents.

SC-7.06 Concerning Subcontractors, Suppliers, and Others

SC 7.06.A Amend Paragraph 7.06.A by adding the following text to the end of the Paragraph:

The Contractor shall not award work valued at more than fifty percent of the Contract Price to Subcontractor(s), without prior written approval of the Owner.

SC 7.06.B Delete paragraph 7.06.B in its entirety and insert "Deleted" in its place.

SC 7.06.E Amend the second sentence of Paragraph 7.06.E by striking out "Owner may also require Contractor to retain specific replacements; provided, however, that".

SC-7.08 Permits

Delete last sentence of Paragraph 7.08.A and add the following in its place:

See General Requirements and technical specification sections for utility charge provisions.

Add Paragraph 7.08.B as follows:

- B. See General Requirements for additional permit information.

SC-7.10 Laws and Regulations

Add Paragraph 7.10.D as follows:

- D. Contractor shall comply with the following Kentucky Bidding & Wage Requirements:

Kickback Statutes—Contractor shall comply with the requirements of KRS 45A.455 with respect to gratuities and kickbacks among other matters.

Campaign Finance Disclosure—Contractor shall comply with requirements of KRS 45A.395 with respect to campaign finance laws.

Labor Law Disclosures—Contractor shall comply with requirements of KRS 45A.343 with respect to labor law disclosure.

Payment Bond for Wages Due—Contractor, whether a corporation, partnership, or individual, who have not been doing business in the State of Kentucky for five consecutive years, shall comply with KRS 337.200 which requires a Performance Bond to assure payment of wages.

SC-7.11 Record Documents

Replace Paragraph 7.11.A with the following:

Contractor shall maintain in a safe place at the Site one printed record copy of all Drawings, Specifications, Addenda, Change Orders, Work Change Directives, Field Orders, written interpretations and clarifications, and approved Shop Drawings. Manufacturers' Certification letter is documentation provided by the manufacturer, supplier, distributor, vendor, fabricator, etc. to various entities stating that the iron and steel products to be used in the project are produced in the United States in accordance with American Iron and Steel Requirements. Refer to Manufacturer's Certification Letter provided in these Contract Documents. Contractor shall keep such record documents in good order and annotate them to show changes made during construction. These record documents, together with all approved Samples, will be available to Engineer for reference. Upon completion of the Work, Contractor shall deliver these record documents to Engineer. Upon completion of the Work, these record documents, samples, and shop drawings shall be delivered by Contractor to Owner.

SC-7.13 Competent Person

Add the following new paragraph immediately after Paragraph 7.13.A:

B. Contractor shall keep at the Site at all times during the progress of the Work a competent person to comply with OSHA trenching and excavation requirements. The competent person shall be one who is capable of identifying existing and predictable hazards in the surroundings, or working conditions that are unsanitary, hazardous or dangerous to employees, and who has authorization to take prompt corrective measures to eliminate them.

SC-7.16 Shop Drawings

Add Paragraph 7.16.A.1.e:

- e. obtain the Manufacturer's Certification letter for any item in the submittal subject to American Iron and Steel requirements and include the Certificate in the submittal. Refer to Manufacturer's Certification Letter provided in these Contract Documents.

Add Paragraph 7.16.D.9

- 9. Engineer's review and approval of Shop Drawing or Sample shall include review of compliance with American Iron and Steel requirements, as applicable.

Add the following new paragraphs immediately after Paragraph 7.16.E:

F. Contractor shall furnish required submittals with sufficient information and accuracy in order to obtain required approval of an item with no more than three submittals. Engineer will record Engineer's time for reviewing subsequent submittals of Shop Drawings, samples or other items requiring approval and Contractor shall reimburse Owner for Engineer's charges for such time.

G. In the event that Contractor requests a substitution for a previously approved item, Contractor shall reimburse Owner for Engineer's charges for its review time unless the need for such change is beyond the control of Contractor.

SC-7.17 Contractor's General Warranty and Guarantee

Add Paragraph 7.17.E:

E. Contractor shall certify upon Substantial Completion that all Work and Materials has complied with American Iron and Steel requirements as mandated and subsequent statutes mandating

domestic preference. Contractor shall provide Contractor's Certification Letter to Owner. Refer to General Contractor's Certification Letter provided in these Contract Documents.

SC-7.18 Indemnification

Add the following to the end of Paragraph 7.18.A:

In addition, Contractor shall indemnify, hold harmless, and pay for the defense of Owner and Engineer from and against claims, losses, or damages in regard to any act or failure to act by Owner or Engineer in connection with general supervision, inspection and/or coordination of Contractor's operations.

Contractor shall, at its own expense, appear, defend, and pay all fees of attorneys and all costs and other expenses arising therefrom or incurred in connection therewith; and, if any judgments shall be rendered against any individual or entity indemnified hereunder in any such action, Contractor shall, at its own expense, satisfy and discharge same. Contractor expressly understands and agrees that any Letter of Credit or insurance protection required by the Contract, or otherwise provided by Contractor, shall in no way limit the responsibility to indemnify, keep and, save harmless, and defend any individual or entity indemnified hereunder as herein provided.

Delete Paragraph 7.18.C.1 and 7.18.C.2. Insert new Paragraphs 7.18.C.1 and D:

1. the preparation of Drawings, Specifications, or Property Surveys.

D. For any matter for which Owner and Engineer are indemnified under Paragraph 7.18.A, Contractor shall pay for Owner's and Engineer's reasonable defense, including, but not limited to, all fees and charges of engineers, architects, attorneys, and other professionals and all court or arbitration or other dispute resolution costs or awards until Owner or Engineer are found negligent. If Owner or Engineer are found negligent, Owner or Engineer shall reimburse Contractor for the prorata extent of Owner's or Engineer's negligence for the cost of Owner's or Engineer's reasonable defense.

SC-7.19 Delegation of Professional Design Services

Add the following new paragraphs immediately after Paragraph 7.19.E:

F. The design professional providing the design calculations and design drawings shall be licensed in the State of the Project.

G. The design calculation and design drawings are not shop drawings, but shall be submitted to ENGINEER separately along with the required shop drawings for the system, material, or equipment specified. These calculations will be forwarded to OWNER for their records.

SC-10.03 Project Representative

Add the following new paragraphs immediately after Paragraph 10.03.A:

B. The Resident Project Representative (RPR) will be Engineer's representative at the Site, will act as directed by and under the supervision of Engineer, and will confer with Engineer regarding RPR's actions.

1. General: RPR's dealings in matters pertaining to the Work in general shall be with Engineer and Contractor. RPR's dealings with Subcontractors shall only be through or with the full knowledge and approval of Contractor. RPR shall generally communicate with Owner only with the knowledge of and under the direction of Engineer.

2. Schedules: Review the progress schedule, schedule of Shop Drawing and Sample submittals, and Schedule of Values prepared by Contractor and consult with Engineer concerning acceptability.

3. Conferences and Meetings: Attend meetings with Contractor, such as preconstruction conferences, progress meetings, job conferences, and other Project-related meetings, and prepare and circulate copies of minutes thereof.

4. Liaison:

a. Serve as Engineer's liaison with Contractor. Working principally through Contractor's authorized representative or designee, assist in providing information regarding the provisions and intent of the Contract Documents.

b. Assist Engineer in serving as Owner's liaison with Contractor when Contractor's operations affect Owner's on-Site operations.

c. Assist in obtaining from Owner additional details or information, when required for proper execution of the Work.

5. Interpretation of Contract Documents: Report to Engineer when clarifications and interpretations of the Contract Documents are needed and transmit to Contractor clarifications and interpretations as issued by Engineer.

6. Shop Drawings and Samples:

a. Record date of receipt of Samples and Contractor-approved Shop Drawings.

b. Receive Samples which are furnished at the Site by Contractor, and notify Engineer of availability of Samples for examination.

c. Advise Engineer and Contractor of the commencement of any portion of the Work requiring a Shop Drawing or Sample submittal for which RPR believes that the submittal has not been approved by Engineer.

7. Modifications: Consider and evaluate Contractor's suggestions for modifications in Drawings or Specifications and report such suggestions, together with RPR's recommendations, if any, to Engineer. Transmit to Contractor in writing decisions as issued by Engineer.

8. Review of Work and Rejection of Defective Work:

a. Conduct on-Site observations of Contractor's work in progress to assist Engineer in determining if the Work is in general proceeding in accordance with the Contract Documents.

b. Report to Engineer whenever RPR believes that any part of Contractor's work in progress is defective, will not produce a completed Project that conforms generally to the Contract Documents, or will imperil the integrity of the design concept of the completed Project as a functioning whole as indicated in the Contract Documents, or has been damaged, or does not meet the requirements of any inspection, test or approval required to be made; and advise Engineer of that part of work in progress that RPR believes should be corrected or rejected or should be uncovered for observation, or requires special testing, inspection or approval.

9. Inspections, Tests, and System Start-ups:

a. Verify that tests, equipment, and systems start-ups and operating and maintenance training are conducted in the presence of appropriate Owner's personnel, and that Contractor maintains adequate records thereof.

b. Observe, record, and report to Engineer appropriate details relative to the test procedures and systems start-ups.

10. Records:

a. Prepare a daily report or keep a diary or log book, recording Contractor's hours on the Site, Subcontractors present at the Site, weather conditions, data relative to questions of Change Orders, Field Orders, Work Change Directives, or changed conditions, Site visitors, deliveries of equipment or materials, daily activities, decisions, observations in general, and specific observations in more detail as in the case of observing test procedures; and send copies to Engineer.

b. Record names, addresses, fax numbers, e-mail addresses, web site locations, and telephone numbers of all Contractors, Subcontractors, and major Suppliers of materials and equipment.

c. Maintain records for use in preparing Project documentation.

11. Reports:

a. Furnish to Engineer periodic reports as required of progress of the Work and of Contractor's compliance with the Progress Schedule and schedule of Shop Drawing and Sample submittals.

b. Draft and recommend to Engineer proposed Change Orders, Work Change Directives, and Field Orders. Obtain backup material from Contractor.

c. Immediately notify Engineer of the occurrence of any Site accidents, emergencies, acts of God endangering the Work, force majeure or delay events, damage to property by fire or other causes, or the discovery of any Constituent of Concern or Hazardous Environmental Condition.

12. Payment Requests: Review applications for payment with Contractor for compliance with the established procedure for their submission and forward with recommendations to Engineer, noting particularly the relationship of the payment requested to the Schedule of Values, Work completed, and materials and equipment delivered at the Site but not incorporated in the Work.

13. Certificates, Operation and Maintenance Manuals: During the course of the Work, verify that materials and equipment certificates, operation and maintenance manuals and other data required by the Contract Documents to be assembled and furnished by Contractor are applicable to the items actually installed and in accordance with the Contract Documents, and have these documents delivered to Engineer for review and forwarding to Owner prior to payment for that part of the Work.

14. Completion:

a. Participate in Engineer's visits to the Site to determine Substantial Completion, assist in the determination of Substantial Completion and the preparation of a punch list of items to be completed or corrected.

b. Participate in Engineer's final visit to the Site to determine completion of the Work, in the company of Owner and Contractor, and prepare a final punch list of items to be completed and deficiencies to be remedied.

c. Observe whether all items on the final list have been completed or corrected and make recommendations to Engineer concerning acceptance and issuance of the notice of acceptability of the work.

C. The RPR shall not:

1. Authorize any deviation from the Contract Documents or substitution of materials or equipment (including "or-equal" items).
2. Exceed limitations of Engineer's authority as set forth in the Contract Documents.
3. Undertake any of the responsibilities of Contractor, Subcontractors, or Suppliers.
4. Advise on, issue directions relative to, or assume control over any aspect of the means, methods, techniques, sequences or procedures of Contractor's work.
5. Advise on, issue directions regarding, or assume control over security or safety practices, precautions, and programs in connection with the activities or operations of Owner or Contractor.
6. Participate in specialized field or laboratory tests or inspections conducted off-site by others except as specifically authorized by Engineer.
7. Accept Shop Drawing or Sample submittals from anyone other than Contractor.
8. Authorize Owner to occupy the Project in whole or in part.

SC-10.10. American Iron & Steel

Add Paragraph 10.10.A

A. Services required to determine and certify that to the best of the Engineer's knowledge and belief all iron and steel products referenced in engineering analysis, the Plans, Specifications, Bidding Documents, and associated Bid Addenda requiring design revisions are either produced in the United States or are the subject of an approved waiver and services required to determine to the best of the engineer's knowledge and belief that approved substitutes, equals, and all iron and steel products proposed in the shop drawings, Change Orders and Partial Payment Estimates are either produced in the United States or are the subject of an approved waiver under the Consolidated Appropriations Act of 2017.

SC-11.01 Amending the Contract Documents; Changes in the Work

Delete Paragraph 11.01.A.1.b in its entirety.

SC-11.02 Owner-Authorized Changes in the Work

Amend the second sentence in Paragraph 11.02.A to read as follows: Such changes shall be supported by ENGINEER's recommendation.

SC-11.04 Change of Contract Price

Add the following sentence at the end of paragraph 11.04.B.2:

Any overhead and profit allowance for lump sum work shall be in accordance with paragraph 11.04.C.2. unless OWNER and CONTRACTOR agree that these allowances are not appropriate for the Work involved.

SC-11.06. Change Proposals

Modify Paragraph 11.06.A.1

Inserting the following sentence after “within 15 days after the submittal of the Change Proposal.”: “Include supporting data (name of manufacturer, city and state where the product was manufactured, description of product, signature of authorized manufacturer’s representative) in the Manufacturer’s Certification Letter, as applicable.”

Delete Paragraph 11.06.B in its entirety.

SC-11.07 Execution of Change Orders

Delete Paragraphs 11.07.A and 11.07.B in their entirety and insert the following in their place:

A. OWNER and CONTRACTOR shall execute appropriate Change Orders recommended by ENGINEER covering:

1. Changes in the Work which are: (a) ordered by OWNER pursuant to Paragraph 11.02, (b) required because of acceptance of defective Work under Paragraph 14.04 or OWNER’s correction of defective Work under Paragraph 14.07, or (c) agreed to by the parties;
2. Changes in the Contract Price or Contract Times which are agreed to by the parties, including any undisputed sum or amount of time for Work actually performed in accordance with a Work Change Directive; and
3. Changes in the Contract Price or Contract Times which embody the substance of any written decision rendered by ENGINEER pursuant to Paragraph 12.01; provided that, in lieu of executing any such Change Order, an appeal may be taken from any such decision in accordance with the provisions of the Contract Documents and applicable Laws and Regulations, but during any such appeal, CONTRACTOR shall carry on the Work and adhere to the Progress Schedule as provided in Paragraph 4.04.B.
4. All Contract Change Orders must be concurred by Agency before they are effective or can be eligible for reimbursement.

SC-11.08 Notification to Surety

Add the following new paragraphs immediately after Paragraph 11.08.A:

B. Contractor shall be responsible for notifying the surety of any assignment, modification, or change of the Contract, change in the Work covered thereby, or extension of time for the completion of the project.

C. Failure to provide notice to the surety of any such change shall not exonerate the surety from its obligations under the bond.

SC-12.01.A Claims Process

Insert the following immediately after “Claims Process” in Paragraph 12.01.A:

All Claims, except those waived pursuant to Paragraph 15.07, shall be referred to ENGINEER for decision. A decision by ENGINEER shall be required as a condition precedent to any exercise by OWNER or CONTRACTOR of any rights or remedies either may otherwise have under the Contract Documents or by Laws and Regulations in respect of such Claims.

Delete Paragraph 12.01.A.3 in its entirety.

SC-13.02 Allowances

Delete Paragraph 13.02.C in its entirety and insert "Deleted" in its place.

SC-13.03 Unit Price Work

Delete Paragraph 13.03.E in its entirety and insert the following in its place:

E. The unit price of an item of Unit Price Work shall be subject to reevaluation and adjustment under the following conditions:

1. If the Bid price of a particular item of Unit Price Work amounts to 15% or more of the Contract Price and the variation in the quantity of that particular item of Unit Price Work performed by Contractor differs by more than 25% from the estimated quantity of such item indicated in the Agreement; and
2. If there is no corresponding adjustment with respect to any other item of Work; &
3. If Contractor believes that it has incurred additional expense as a result thereof; or
4. If Owner believes that the quantity variation entitles it to an adjustment in the unit price,

either Owner or Contractor may make a Claim for an adjustment in the Contract Price in accordance with Article 10 if the parties are unable to agree as to the effect of any such variations in the quantity of Unit Price Work performed.

SC-14.02.A Tests and Inspections

Add the following to the beginning of Paragraph 14.02.A:

All Work is subject to testing to indicate compliance with Contract Document requirements. Duplicate copies of test results of all tests required shall be submitted to Engineer. Tests and inspection of work may be conducted by Owner or an independent laboratory employed by Owner. Tests may also be performed in the field by Engineer as a basis for acceptance of the Work.

Add the following to the end of Paragraph 14.02.A:

Samples required for testing shall be furnished by Contractor at no cost to Owner. In the event that completed Work does not conform to specification requirements during the initial test, the Work shall be corrected and retested for conformance. The entire cost of retesting completed Work shall be borne by Contractor. This shall include the extra cost for inspection to Owner which will be deducted from the final amount due Contractor.

SC-14.03 Defective Work

Add Paragraph 14.03.G:

G. Installation of Materials that are non-compliant with American Iron and Steel requirements shall be considered defective work.

SC-15.01 Progress Payment

SC 15.01.B Amend the second sentence of Paragraph 15.01.B.1 by striking out the following text: “a bill of sale, invoice, or other.”

SC 15.01.B.3 Add the following language at the end of paragraph 15.01.B.3:

No payments will be made that would deplete the retainage, place in escrow any funds that are required for retainage, or invest the retainage for the benefit of the Contractor.

SC 15.01.B.4 Add the following new Paragraph after Paragraph 15.01.B.3:

The Application for Payment form to be used on this Project is RD Form 1924-18. The Agency must approve all Applications for Payment before payment is made.

SC 15.01.B.5 Add the following new Paragraph after Paragraph 15.01.B.4:

By submitting Materials for payment, Contractor is certifying that the submitted Materials are compliant with American Iron and Steel requirements. Manufacturer’s Certification letter for Materials satisfy this certification. Refer to Manufacturer’s Certification Letter provided in these Contract Documents.

SC 15.01.C.2.d Add the following new Paragraph after Paragraph 15.01.C.2.c:

d. the Materials presented for payment comply with American Iron and Steel.

SC 15.01.D.1 Delete Paragraph 15.01.D.1 in its entirety and insert the following in its place:

The Application for Payment with Engineer’s recommendations will be presented to the Owner and Agency for consideration. If both the Owner and Agency find the Application for Payment acceptable, the recommended amount less any reduction under the provisions of Paragraph 15.01.E will become due twenty (20) days after the Application for Payment is presented to the Owner, and the Owner will make payment to the Contractor.

SC-15.02 Contractor’s Warranty of Title

SC 15.02.A Amend Paragraph 15.02.A by striking out the following text: “no later than seven days after the time of payment by Owner” and insert “no later than the time of payment by Owner.”

SC-15.03 Substantial Completion

Modify 15.03.A by adding the following after the last sentence: “Services required to determine and certify that to the best of the Contractor’s knowledge and belief all substitutes, equals, and all iron and steel products proposed in the shop drawings, Change Orders and Partial Payment Estimates are either produced in the United States or are the subject of an approved waiver. Services required to certify that, to the best of the Contractor’s knowledge, all those products installed for the project are either produced in the United States or are the subject of an approved waiver.”

SC-15.04 Partial Utilization

Add the following new paragraph immediately after Paragraph 15.04.A.3:

4. Owner may at any time request Contractor in writing to permit Owner to take over operation of any part of the Work although it is not substantially complete. A copy of such request will be sent to Engineer, and within a reasonable time thereafter, Owner, Contractor,

and Engineer shall make an inspection of that part of the Work to determine its status of completion and will prepare a list of the items remaining to be completed or corrected thereon before final payment. If Contractor does not object in writing to Owner and Engineer that such part of the Work is not ready for separate operation by Owner, Engineer will finalize the list of items to be completed or corrected and will deliver such lists to Owner and Contractor together with a written recommendation as to the division of responsibilities pending final payment between Owner and Contractor with respect to security, operation, safety, maintenance, utilities, insurance, warranties, and guarantees for that part of the Work which will become binding upon Owner and Contractor at the time when Owner takes over such operation (unless they shall have otherwise agreed in writing and so informed Engineer). During such operation and prior to Substantial Completion of such part of the Work, Owner shall allow Contractor reasonable access to complete or correct items on said list and to complete other related Work.

Paragraph 15.04.A.4 shall be renumbered to 15.04.A.5.

SC-15.08.A Correction Period

Delete in Paragraph 15.08.A the phrase "If within one year after the date of Substantial Completion" and insert in its place the following:

"If thereof began operating or was used in a continuous, satisfactory manner for its intended purpose within one year of the date of final payment or from the date established by Engineer that the Work or portion, whichever is earlier,"

SC-16.02 Owner May Terminate for Cause

Add the following new paragraphs immediately after Paragraph 16.02.B.2:

3. complete the Work as Owner may deem expedient at the expense of Contractor and surety;
 4. apply the amounts retained from partial payments to the completion of the Work;
- and
5. authorize the surety to complete the steps in Paragraphs 16.02.B.1 through 4.

SC-16.03 Owner May Terminate for Convenience

Add the following paragraph after Paragraph 16.03.B:

C. Contractor shall require similar provisions contained in Paragraph 15.03 in each of its subcontracts to protect Contractor from claims by Subcontractors arising from the Owner's termination for convenience, or to minimize claims by such subcontractors. The remedy provided to Contractor under this Paragraph 16.03 shall be Contractor's sole remedy in the event of termination for convenience by Owner.

SC-18 Miscellaneous

SC 18.09 Add the following new paragraph after Paragraph 18.08:

Tribal Sovereignty. No provision of this Agreement will be construed by any of the signatories as abridging or debilitating any sovereign powers of the {insert name of Tribe} Tribe; affecting the trust-beneficiary relationship between the Secretary of the Interior, Tribe, and Indian landowner(s); or interfering with the government-to-government relationship between the United States and the Tribe.

SC 19 Add Article 19 titled "FEDERAL REQUIREMENTS"

SC 19.01 Add the following language as Paragraph 19.01 with the title "Agency Not a Party":

A. This Contract is expected to be funded in part with funds provided by Agency. Neither Agency, nor any of its departments, entities, or employees is a party to this Contract.

SC 19.02 Add the following sections after Article 19.01 with the title "Contract Approval":

A. Owner and Contractor will furnish Owner's attorney such evidence as required so that Owner's attorney can complete and execute the "Certificate of Owner's Attorney" before Owner submits the executed Contract Documents to Agency for approval.

B. Concurrence by Agency in the award of the Contract is required before the Contract is effective.

SC 19.03 Add the following language after Article 19.02.B with the title "Conflict of Interest":

A. Contractor may not knowingly contract with a supplier or manufacturer if the individual or entity who prepared the plans and specifications has a corporate or financial affiliation with the supplier or manufacturer. Owner's officers, employees, or agents shall not engage in the award or administration of this Contract if a conflict of interest, real or apparent, would be involved. Such a conflict would arise when: (i) the employee, officer or agent; (ii) any member of their immediate family; (iii) their partner or (iv) an organization that employs, or is about to employ, any of the above, has a financial interest in Contractor. Owner's officers, employees, or agents shall neither solicit nor accept gratuities, favors or anything of monetary value from Contractor or subcontractors.

SC 19.04 Add the following language after Article 19.03.A with the title "Gratuities":

A. If Owner finds after a notice and hearing that Contractor, or any of Contractor's agents or representatives, offered or gave gratuities (in the form of entertainment, gifts, or otherwise) to any official, employee, or agent of Owner or Agency in an attempt to secure this Contract or favorable treatment in awarding, amending, or making any determinations related to the performance of this Contract, Owner may, by written notice to Contractor, terminate this Contract. Owner may also pursue other rights and remedies that the law or this Contract provides. However, the existence of the facts on which Owner bases such findings shall be an issue and may be reviewed in proceedings under the dispute resolution provisions of this Contract.

B. In the event this Contract is terminated as provided in paragraph 19.04.A, Owner may pursue the same remedies against Contractor as it could pursue in the event of a breach of this Contract by Contractor. As a penalty, in addition to any other damages to which it may be entitled by law, Owner may pursue exemplary damages in an amount (as determined by Owner) which shall not be less than three nor more than ten times the costs Contractor incurs in providing any such gratuities to any such officer or employee.

SC 19.05 Add the following language after Article 19.04.B with the title "Audit and Access to Records":

A. Owner, Agency, the Comptroller General of the United States, or any of their duly authorized representatives, shall have access to any books, documents, papers, and records of the Contractor which are pertinent to the Agreement, for the purpose of making audits, examinations, excerpts, and transcriptions. Engineer shall maintain all required records for three years after final payment is made and all other pending matters are closed.

SC 19.06 Add the following language after Article 19.05.A with the title "Small, Minority and Women's Businesses":

A. If Contractor intends to let any subcontracts for a portion of the work, Contractor shall take affirmative steps to assure that small, minority and women's businesses are used when possible as sources of supplies, equipment, construction, and services. Affirmative steps shall consist of: (1) including qualified small, minority and women's businesses on solicitation lists; (2) assuring that small, minority and women's businesses are solicited whenever they are potential sources; (3) dividing total requirements when economically feasible, into small tasks or quantities to permit maximum participation of small, minority, and women's businesses; (4) establishing delivery schedules, where the requirements of the work permit, which will encourage participation by small, minority and women's businesses; (5) using the services and assistance of the Small Business Administration and the Minority Business Development Agency of the U.S. Department of Commerce; (6) requiring each party to a subcontract to take the affirmative steps of this section; and (7) Contractor is encouraged to procure goods and services from labor surplus area firms.

SC 19.07 Add the following after Article 19.06.A with the title "Anti-Kickback":

A. Contractor shall comply with the Copeland Anti-Kickback Act (18 USC 874 and 40 USC 276c) as supplemented by Department of Labor regulations (29 CFR Part 3, "Contractors and Subcontractors on Public Buildings or Public Works Financed in Whole or in Part by Loans or Grants of the United States"). The Act provides that Contractor or subcontractor shall be prohibited from inducing, by any means, any person employed in the construction, completion, or repair of public facilities, to give up any part of the compensation to which they are otherwise entitled. Owner shall report all suspected or reported violations to Agency.

SC 19.08 Add the following after Article 19.07.A with the title "Clean Air and Pollution Control Acts":

A. If this Contract exceeds \$100,000, compliance with all applicable standards, orders, or requirements issued under section 306 of the Clean Air Act (42 U.S.C. 1857(h) and 42 USC 7401et. seq.), section 508 of the Clean Water Act (33 U.S.C. 1368) and Federal Water Pollution Control Act (33 USC 1251 et seq.), Executive Order 11738, and Environmental Protection Agency regulations is required. Contractor will report violations to the Agency and the Regional Office of the EPA.

SC 19.09 Add the following after Article 19.08 with the title "State Energy Policy":

A. Contractor shall comply with the Energy Policy and Conservation Act (P.L. 94-163). Mandatory standards and policies relating to energy efficiency, contained in any applicable State Energy Conservation Plan, shall be utilized.

SC 19.10 Add the following after Article 19.09 with the title "Equal Opportunity Requirements":

A. If this Contract exceeds \$10,000, Contractor shall comply with Executive Order 11246, "Equal Employment Opportunity," as amended by Executive Order 11375, "Amending Executive Order 11246 Relating to Equal Employment Opportunity," and as supplemented by regulations at 41 CFR part 60, "Office of Federal Contract Compliance Programs, Equal Employment Opportunity, Department of Labor."

B. Contractor's compliance with Executive Order 11246 shall be based on its implementation of the Equal Opportunity Clause, specific affirmative active obligations required by the Standard Federal Equal Employment Opportunity Construction Contract Specifications, as set forth in 41

CFR Part 60-4 and its efforts to meet the goals established for the geographical area where the Contract is to be performed. The hours of minority and female employment and training must be substantially uniform throughout the length of the Contract, and in each trade, and Contractor shall make a good faith effort to employ minorities and women evenly on each of its projects. The transfer of minority or female employees or trainees from Contractor to Contractor or from project to project for the sole purpose of meeting Contractor's goals shall be a violation of the Contract, the Executive Order, and the regulations in 41 CFR part 60-4. Compliance with the goals will be measured against the total work hours performed.

C. Contractor shall provide written notification to the Director of the Office of Federal Contract Compliance Programs within 10 working days of award of any construction subcontract in excess of \$10,000 at any tier for construction work under the Contract resulting from this solicitation. The notification shall list the name, address, and telephone number of the subcontractor; employer identification number; estimated dollar amount of subcontract; estimated starting and completion dates of the subcontract; and the geographical area in which the Contract is to be performed.

SC 19.11 Add the following after Article 19.10.C with the title "Restrictions on Lobbying":

A. Contractor and each subcontractor shall comply with Restrictions on Lobbying (Public Law 101-121, Section 319) as supplemented by applicable Agency regulations. This Law applies to the recipients of contracts and subcontracts that exceed \$100,000 at any tier under a Federal loan that exceeds \$150,000 or a Federal grant that exceeds \$100,000. If applicable, Contractor must complete a certification form on lobbying activities related to a specific Federal loan or grant that is a funding source for this Contract. Each tier certifies to the tier above that it will not and has not used Federal appropriated funds to pay any person or organization for influencing or attempting to influence an officer or employee of any agency, a member of Congress, or an employee of a member of Congress in connection with obtaining any Federal contract, grant, or any other award covered by 31 U.S.C. 1352. Each tier shall disclose any lobbying with non-Federal funds that takes place in connection with obtaining any Federal award. Certifications and disclosures are forwarded from tier to tier up to the Owner. Necessary certification and disclosure forms shall be provided by Owner.

SC 19.12 Add the following after Article 19.11.A with the title "Environmental Requirements":

When constructing a Project involving trenching and/or other related earth excavations, Contractor shall comply with the following environmental conditions:

A. Wetlands –When disposing of excess, spoil, or other construction materials on public or private property, Contractor shall not fill in or otherwise convert wetlands.

B. Floodplains –When disposing of excess, spoil, or other construction materials on public or private property, Contractor shall not fill in or otherwise convert 100-year floodplain areas (Standard Flood Hazard Area) delineated on the latest Federal Emergency Management Agency Floodplain Maps, or other appropriate maps, e.g., alluvial soils on NRCS Soil Survey Maps.

C. Historic Preservation – Any excavation by Contractor that uncovers an historical or archaeological artifact or human remains shall be immediately reported to Owner and a representative of Agency. Construction shall be temporarily halted pending the notification process and further directions issued by Agency after consultation with the State Historic Preservation Officer (SHPO).

D. Endangered Species – Contractor shall comply with the Endangered Species Act, which provides for the protection of endangered and/or threatened species and critical habitat. Should any evidence of the presence of endangered and/or threatened species or their critical habitat be brought to the attention of Contractor, Contractor will immediately report this evidence to Owner and a representative of Agency. Construction shall be temporarily halted pending the notification process and further directions issued by Agency after consultation with the U.S. Fish and Wildlife Service.

E. Mitigation Measures – Environmental mitigation measures for the Project are noted on the Plan Sheets.

SC 19.13 Add the following after Article 19.12.E:

Add “Section 746 of Title VII of the Consolidated Appropriations Act of 2017 (Division A - Agriculture, Rural Development, Food and Drug Administration, and Related Agencies Appropriations Act, 2017) and subsequent statutes mandating domestic preference applies an American Iron and Steel requirement to this project. All iron and steel products used in this project must be produced in the United States. The term “iron and steel products” means the following products made primarily of iron or steel: lined or unlined pipes and fittings, manhole covers and other municipal castings, hydrants, tanks, flanges, pipe clamps and restraints, valves, structural steel, reinforced precast concrete, and construction materials. The de minimis and minor components waiver apply to this contract as defined in the Contract Documents..”

SC 19.14 “Definitions” - Add the following after Article 19.13:

“Assistance recipient” is the entity that receives funding assistance from programs required to comply with AIS requirements in the Consolidated Appropriations Act of 2017 and any subsequent statutes mandating domestic preference. This term includes owner and/or applicant.

“Certifications” means the following:

- *Manufacturers’* certification is documentation provided by the manufacturer or fabricator to various entities stating that the iron and steel products to be used in the project are produced in the United States in accordance with American Iron and Steel (AIS) Requirements. If items are purchased via a supplier, distributor, vendor, etc. vs. from the manufacturer or fabricator directly, then the supplier, distributor, vendor, etc. will be responsible for obtaining and providing these certification letters to the parties purchasing the products.
- *Engineers’* certification is documentation that plans, specifications, and bidding documents comply with AIS.
- *Contractors’* certification is documentation submitted upon substantial completion of the project that all iron and steel products installed were produced in the United States.

“Coating” means a covering that is applied to the surface of an object. If a coating is applied to the external surface of a domestic iron or steel component, and the application takes place outside of the United States, said product would be considered a compliant product under the AIS requirements. Any coating processes that are applied to the external surface of iron and steel components that would otherwise be AIS compliant would not disqualify the product from meeting the AIS requirements regardless of where the coating processes occur, provided that final assembly of the product occurs in the United States. This exemption only applies to coatings on the *external surface* of iron and steel components, such as the lining of lined pipes. All manufacturing processes for lined pipes, including the application of pipe lining, must occur in the United States for the product to be compliant with AIS requirements.

“Contractor” is the individual or entity with which the applicant has contractor (or is expected to) to perform construction services (or for water and waste projects funded by the programs which are

subject to AIS requirements). This includes bidders and/or contractors that have received an award from the applicant and any party having a direct contractual relationship with the owner/applicant. A general contractor is often referred to as the prime contractor.

“Construction materials” are those articles, materials, or supplies made primarily of iron and steel, that are permanently incorporated into the project, not including mechanical and/or electrical components, equipment and systems. Some of these products may overlap with what is also considered “structural steel”.

“Engineer” is an individual or entity with which the owner has contracted to perform engineering/architectural services for water and waste projects funded by the programs subject to AIS requirements).

“De minimis incidental components” are various miscellaneous low-cost components that are essential for, but incidental to, the construction and are incorporated into the physical structure of the project. Examples of incidental components could include small washers, screws, fasteners (such as “off the shelf” nuts and bolts, miscellaneous wire, corner bead, ancillary tube, signage, trash bins, door hardware etc.) Costs for de minimis incidental components cumulatively may comprise no more than a total of five percent of the total cost of the materials used in and incorporated into a project; the cost of an individual item may not exceed one percent of the total cost of the materials used in and incorporated into a project.

“General contractor” is the individual or entity with which the applicant has contracted (*or is expected to*) to perform construction services (or for water and waste projects funded by the programs subject to AIS requirements). This includes bidders, contractors that have received an award from the applicant and any party having a direct contractual relationship with the owner/applicant. A general contractor is often referred to as the prime contractor.

“Iron and steel products” are defined as the following products made primarily of iron or steel: lined or unlined pipes and fittings, manhole covers and other municipal castings, hydrants, tanks, flanges, pipe clamps and restraints, valves, structural steel, reinforced precast concrete, and construction materials. Only items on the above list made primarily of iron or steel, permanently incorporated into the project must be produced in the United States. For example trench boxes, scaffolding or equipment, which are removed from the project site upon completion of the project, are not required to be made of U.S. Iron or Steel.

“Manufacturers” meaning a supplier, fabricator, distributor, materialman, or vendor is an entity with which the applicant, general contractor or with any subcontractor has contracted to furnish materials or equipment to be incorporated in the project by the applicant, contractor or a subcontractor.

“Manufacturing processes” are processes such as melting, refining, forming, rolling, drawing, finishing, and fabricating. Further, if a domestic iron and steel product is taken out of the United States for any part of the manufacturing process, it becomes foreign source material. However, raw materials such as iron ore, limestone and iron and steel scrap are not covered by the AIS requirement, and the material(s), if any, being applied as a coating are similarly not covered. Non-iron or steel components of an iron and steel product may come from non-US sources. For example, for products such as valves and hydrants, the individual non-iron and steel components do not have to be of domestic origin. Raw materials, such as iron ore, limestone, scrap iron, and scrap steel, can come from non-U.S. sources.

“Mechanical equipment” is typically that which has motorized parts and/or is powered by a motor. “Electrical equipment” is typically any machine powered by electricity and includes components that are part of the electrical distribution system. AIS does apply to mechanical equipment.

“Minor components” are components *within* an iron and/or steel product otherwise compliant with the American Iron and Steel requirements. This is different from the de minimis definition where de minimis pertains to the entire project and the minor component definition pertains to a single product. This waiver, would allow non-domestically produced miscellaneous minor components comprising up to five percent of the total material cost of an otherwise domestically produced iron and steel product to be used. However, unless a separate waiver for a product has been approved, all other iron and steel components in said product must still meet the AIS requirements. This waiver does not exempt the whole product from the AIS requirements only minor components within said product and the iron or steel components of the product must be produced domestically. Valves and hydrants are also subject to the cost ceiling requirements described here. Examples of minor components could include items such pins and springs in valves/hydrants, bands/straps in couplings, and other low cost items such as small fasteners etc.

“Municipal castings” are cast iron or steel infrastructure products that are melted and cast. They typically provide access, protection, or housing for components incorporated into utility owned drinking water, storm water, wastewater, and solid waste infrastructure.

“National Office” refers to the office responsible for the oversight and administration of the program nationally. The National Office sets policy, develops program regulations, and provides training and technical assistance to help the state offices administer the program. The National Office is located in Washington, D.C.

“Owner” is the individual or entity with which the general contractor has contracted regarding the work, and which has agreed to pay the general contractor for the performance of the work, pursuant to the terms of the contract for water and waste projects funded by the programs subject to AIS requirements. For the purpose of this Bulletin, this term is synonymous with the term “applicant” as defined in 7 CFR 1780.7 (a) (1), (2) and (3) and is an entity receiving financial assistance from the programs subject to the AIS requirements.

“Pass through Entities” is an entity that provides a subaward to a loan and/or grant recipient to carry out part of a Federal program. Examples are grantees utilizing the Revolving Loan Program and Household Water Well Program and Alaska Native Tribal Health Consortium (ANTHC) or the State of Alaska from the RAVG Program.

“Primarily iron or steel” is defined as a product made of greater than 50 percent iron or steel, measured by cost. The cost should be based on the material costs. An exception to this definition is reinforced precast concrete (see Definitions). All technical specifications and applicable industry standards (e.g. NIST, NSF, AWWA) must be met. If a product is determined to be less than 50 percent iron and steel, the AIS requirements do not apply.

For example, the cost of a fire hydrant includes:

- (1) The cost of materials used for the iron portion of a fire hydrant (e.g. bonnet, body and shoe); and
- (2) The cost to pour and cast to create those components (e.g. labor and energy).

Not included in the cost are:

- (1) The additional material costs for the non-iron and steel internal workings of the hydrant (e.g. stem, coupling, valve, seals, etc.); and
- (2) The cost to assemble the internal workings into the hydrant body.

“Produced in the United States” means that the production in the United States of the iron or steel products used in the project requires that all manufacturing processes must take place in the United States, with the exception of metallurgical processes involving refinement of steel additives.

“Project” is the total undertaking to be accomplished for the applicant by consulting engineers, general contractors, and others, including the planning, study, design, construction, testing, commissioning, and start-up, and of which the work to be performed under the contract is a part. A project includes all activity that an applicant is undertaking to be financed in whole or part by programs subject to AIS requirements. The intentional splitting of projects into separate and smaller contracts or obligations to avoid AIS requirements is prohibited.

“Reinforced Precast Concrete” may not consist of at least 50 percent iron or steel, but the reinforcing bar and wire must be produced in the United States and meet the same standards as for any other iron or steel product. Additionally, the casting of the concrete product must take place in the United States. The cement and other raw materials used in concrete production are not required to be of domestic origin. If the reinforced concrete is cast at the construction site, the reinforcing bar and wire are considered to be a construction material and must be produced in the United States.

“Steel” means an alloy that includes at least 50 percent iron, between 0.02 and 2 percent carbon, and may include other elements. Metallic elements such as chromium, nickel, molybdenum, manganese, and silicon may be added during the melting of steel for the purpose of enhancing properties such as corrosion resistance, hardness, or strength. The definition of steel covers carbon steel, alloy steel, stainless steel, tool steel, and other specialty steels.

“Structural steel” is rolled flanged shapes, having at least one dimension of their cross-section three inches or greater, which are used in the construction of bridges, buildings, ships, railroad rolling stock, and for numerous other constructional purposes. Such shapes are designated as wide-flange shapes, standard I-beams, channels, angles, tees, and zees. Other shapes include but are not limited to, H-piles, sheet piling, tie plates, cross ties, and those for other special purposes.

“Ultimate recipient” is a loan or grant recipient receiving funds from a pass-through entity. Examples include: (1) a loan recipient from the Revolving Loan Fund; (2) a loan recipient from the Household Water Well Program; and (3) a grant recipient from ANTHC or the State of Alaska from the RAVG Program.

“United States” means each of the several states, the District of Columbia, and each Federally Recognized Indian Tribe.

UNITED STATES DEPARTMENT OF AGRICULTURE
RURAL DEVELOPMENT AND
FARM SERVICE AGENCY

CONTRACT CHANGE ORDER

| |
|-----------|
| ORDER NO. |
| DATE |
| STATE |
| COUNTY |

CONTRACT FOR _____

OWNER _____

To _____
(Contractor)

You are hereby requested to comply with the following changes from the contract plans and specifications:

| Description of Changes (Supplemental Plans and Specifications Attached) | DECREASE in Contract Price | INCREASE in Contract Price |
|--|-------------------------------|-------------------------------|
| | \$ _____ | \$ _____ |
| TOTALS | \$ _____ | _____ |
| NET CHANGE IN CONTRACT PRICE | \$ _____ | _____ |

JUSTIFICATION:

The amount of the Contract will be (Decreased) (Increased) By The Sum Of: _____

_____ Dollars (\$ _____).

The Contract Total Including this and previous Change Orders Will Be: _____

_____ Dollars (\$ _____).

The Contract Period Provided for Completion Will Be (Increased) (Decreased) (Unchanged): _____ Days.

This document will become a supplement to the contract and all provisions will apply hereto.

Requested _____
(Owner) _____
(Date)

Recommended _____
(Owner's Architect/Engineer) _____
(Date)

Accepted _____
(Contractor) _____
(Date)

Approved by Agency _____
(Name and Title) _____
(Date)

Public reporting burden for this collection of information is estimated to average 15 minutes per response, including the time for reviewing instructions, searching existing data sources, gathering and maintaining the data needed, and completing and reviewing the collection of information. Send comments regarding this burden estimate or any other aspect of this collection of information, including suggestions for reducing this burden, to U.S. Department of Agriculture, Clearance Officer, STOP 7602, 1400 Independence Avenue, S.W., Washington, D.C. 20250-7602. Please DO NOT RETURN this form to this address. Forward to the local USDA office only. You are not required to respond to this collection of information unless it displays a currently valid OMB control number.

TEMPORARY CONSTRUCTION SIGN FOR RURAL DEVELOPMENT PROJECTS

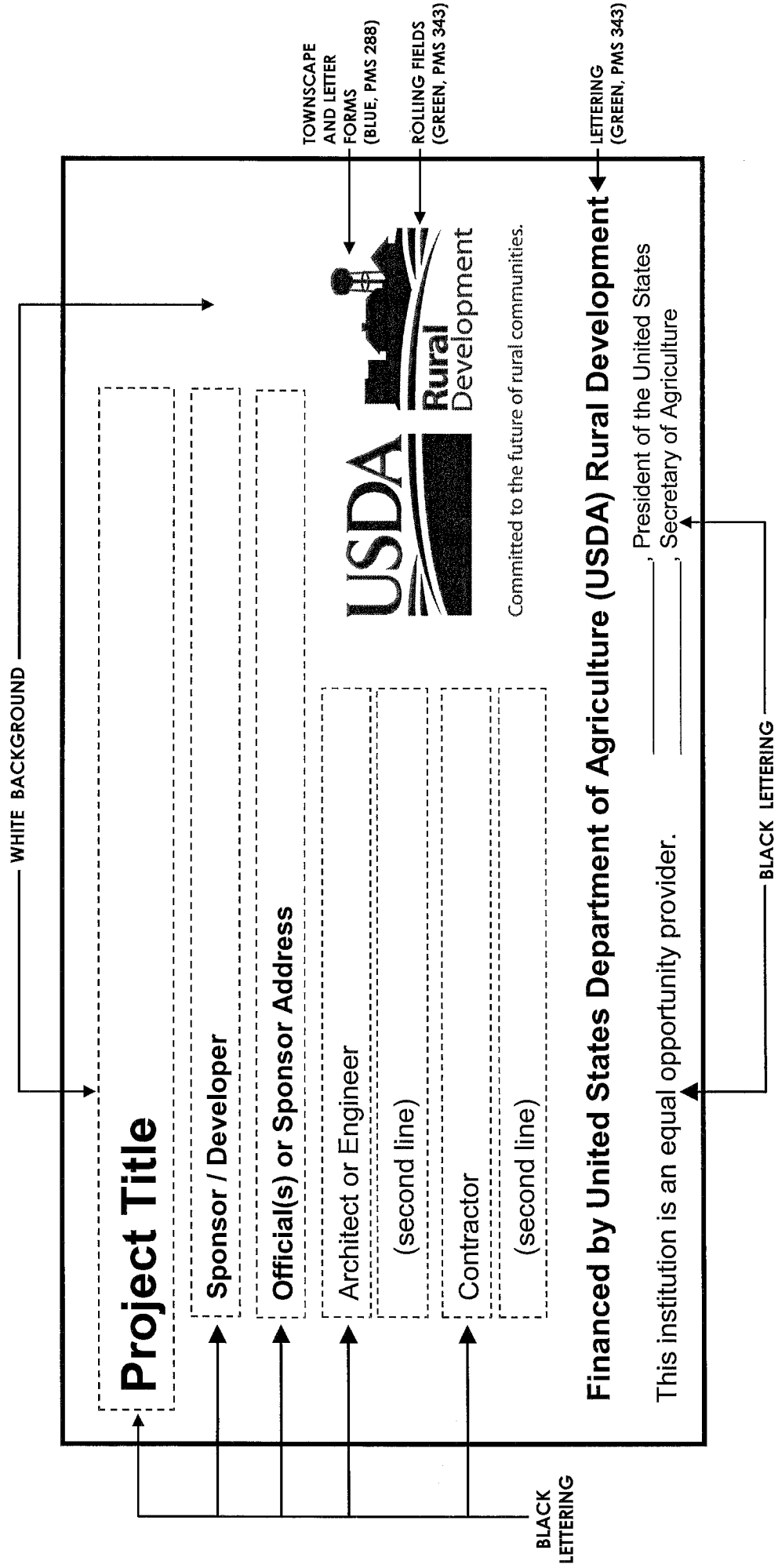

SIGN DIMENSIONS: 1200 mm x 2400 mm x 19 mm (approx. 4' x 8' x 3/4")
PLYWOOD PANEL (APA RATED A-B GRADE-EXTERIOR)

PROJECT SPECIAL CONDITIONS

1. Project Special Conditions: These Special Conditions supplement the "Standard General Conditions" and the "Supplementary Conditions" within the Contract Documents. The Engineer's decision shall be final as to interpretation and/or conflict between any of the reference specifications and standards contained herein.
2. Additional Definitions: Wherever the following terms are used in these specifications, their meaning shall be construed in accordance with the definitions listed below.
 - a. Engineer: McGhee Engineering, Inc., P.O. Box 267, 202 Ewing Street, Guthrie, Kentucky 42234, telephone (270) 483-9985.
 - b. Inspector: Representative of the Engineer or Owner stationed at, or visiting the site of the work to secure conformity with the Plans and Specifications, to record the work performed by the Contractor and to serve in such other capacities as the Engineer may direct.
 - c. Plans: All drawings adopted by the Engineer and bound herein pertaining to the work under this contract.
 - d. ASTM Specifications: Adopted by the American Society for Testing and Materials, governing the methods and procedures for manufacturing and testing materials and bearing appropriate alphabetical and numerical designations pertinent to the various items involved.
 - e. OSHA: Occupational Health and Safety Administration requirements pertaining to the project.

3. The following abbreviations will be used in these Specifications, the Proposal and contract:

| | |
|------------|-------------|
| LF or L.F. | Linear Foot |
| SF or S.F. | Square Foot |
| LS or L.S. | Lump Sum |
| EA or Ea | Each |
| SQ. IN. | Square Inch |
| LBS. | Pounds |
| LIN. IN. | Linear Inch |

4. Safety Standards and Accident Prevention: With respect to all work performed under this contract, the contractor shall:

4.1 Comply with the safety standards provision of applicable laws, building and construction codes and the "Manual of Accident Prevention in Construction" published by the Associated General Contractors of America, the requirements of the Occupational Safety and Health Act of 1970 (Public Law 91-596), and the requirements of Title 29 of the Code of Federal Regulations, Section 1518 as published in the "federal Register", Volume 36, No. 75, Saturday, April 17, 1971.

4.2 Exercise every precaution at all times for the prevention of accidents and the protection of persons (including employees) and property.

4.3 Maintain at his/her office or other well know place at the job site, all articles necessary for giving first aid to the injured, and shall make standing arrangements for the immediate removal to a hospital or a doctor's care of persons (including employees), who may be injured on the job site before the employer has made a standing arrangement for removal of injured persons to a hospital or a doctor's care.

5. Completion Time and Liquidated Damages: The project as indicated in the Plans and Specifications shall be completed within the number of consecutive working days stated in the Contract. Contractors shall submit any request for time extensions at the time of submission of the pay request covering the period

during which the time extension is requested, and such requests shall include justification in conformance with the Contract. Failure to make timely submittal of requests for time extension shall be grounds for their denial. The times set forth in the Proposal for completion of work are an essential element of the Contract. The Contractor and Owner understand and agree that a breach of this Contract as to completion on time will cause damage to the Owner. The parties agree that for each and every calendar day the work or any portion thereof shall remain uncompleted after the expiration of the contract time limit, **An amount specified and under the provisions of the Agreement** will be deducted from the money due or to become due the Contractor, not as a penalty, but as liquidated damages and added expense of engineering and overhead.

6. Contractor's Warranty: The Contractor shall guarantee that all work performed under this Contract is new and free of faulty materials in every particular, and free of faulty workmanship, and he does hereby agree to maintain, replace or re-execute without additional cost to the Owner such work found to be unsatisfactory and to make good all damage to his, or work by others affected by this Contract as a result of improper workmanship and materials or due to such required replacement or re-execution.

The Contractor shall warrant all such work for a period of one (1) year from the date of acceptance of all work performed under this Contract. A "Final Certificate" will be issued by the Engineer, as evidence. Neither the "Final Certificate," nor payment, nor any provisions in the Contract Documents shall relieve the Contractor of the guarantee or maintenance provisions, or his responsibility for neglect or the replacement of faulty materials, or workmanship, or any other items of defect during the warranty period.

7. Safety: The Contractor shall be responsible for the safety of himself, his employees and other persons, as well as for the protection of the safety of the improvements being erected and the property of himself or any other person, as a result of his operation. All work shall be done in accordance with the Occupational Safety and Health Administration regulations and all other current federal, state and local laws pertaining to occupational safety, health and welfare. All monitoring and testing required to assure compliance with such requirements shall be the responsibility of the Contractor. The safety of the public, protection of property, and convenience of traffic shall be of prime importance during construction. In all respects, public safety and protection of property and provisions therefor, made necessary by the work, shall be the direct responsibility of the Contractor and shall be performed at his expense.
8. Contractor's Responsibility for Materials and Equipment: The Contractor shall assume full responsibility for all supplies, materials and equipment furnished or installed by him for the work he contracts to do, whether furnished by him or by other parties, until the same shall have been installed and finally tested and accepted by the Engineer. The Contractor shall, therefore, insure such property against loss or damage while stored at the site of the work.
9. Permits, Licenses and Laws: The Contractor shall obtain, at his own expense, all necessary permits and licenses from the proper authorities and shall give all notice required by law or ordinance and shall pay all fees and charges incidental to the due and lawful prosecution of the work and shall comply with all laws, ordinances and regulations relating thereto. Contractor shall obtain necessary building permits; however, there shall be no fees charged to the Contractor by the Owner.

The Owner shall not be responsible to the Contractor for expenses incurred while performing the work under this contract due to the requirements and conditions imposed on the Contractor by any governmental agencies. The Contractor shall investigate with said government as to the requirements and conditions to be imposed.

Copies of said permits, licenses, authorizations or regulations shall be filed with the Owner through the Engineer or his representative. In the event that any work to be performed by the Contractor under the above mentioned permits is found to be unsatisfactory and is not approved by the aforementioned governmental authorities, the cost thereof shall be charged to the Contractor and shall be withheld by the Owner from any money due to the Contractor under the subject construction contract.

10. Labor Laws: The Contractor shall comply with, and shall cause all subcontractors to comply with, the requirements of all applicable labor laws (hours of work, minimum wage, prevailing wage, etc.).

11. Protection of Adjoining Property: Any damage to any property of the Owner or other caused by the Contractor's operations shall be corrected at the Contractor's expense.
12. Cleanup: Upon completion of the work and before acceptance and final payment by the Owner, the Contractor shall remove rubbish, unused materials and temporary structures from the limits of the project and restore, in a manner acceptable to the Engineer, all property both public and private that has been damaged during prosecution of the work, and shall level and grade all portions of the work where the surface of the ground or street surface has been disturbed during construction and shall leave the site of the work in a neat and presentable condition, free from ruts and holes. Areas where vegetation is disturbed by construction shall be graded and re-seeded to the satisfaction of the Owner.

Materials associated with the project shall not be deposited on adjacent property unless prior approval has been obtained from the property owner involved.

No extra payment will be made for these cleanup requirements, its cost being included in the various unit prices bid in this proposal.

13. Resident Construction Observation: The Owner may employ the services of a resident construction observer during construction of the project. The purpose of the resident construction observer is to provide additional assurances to the owner as to the quality of the work and the conformance of the work to the plans and specifications. The resident construction observer is not provided to act as a supervisor of the contractor's activities, nor to take responsibility for the quality or safety of the contractor's work. Such responsibilities remain exclusively with the contractor.
14. Basis of Payment: The basis of payment for all items involved with the project will be made according to the units described in the Proposal breakdown. If there are any conflicts between the basis of payment described in the Specification and the units described in the Proposal breakdown, then the Proposal breakdown will prevail.
15. Inclement Weather: The basis of contract time is calendar days. If during the course of the project, weather conditions prevail that preclude performance of productive work for a number of days in excess of that which would normally be expected for the period, the Contractor may request a compensating time extension.

END OF SECTION

SUMMARY OF WORK

1.0 GENERAL

1.1 Work Included

The work to be performed involves the installation of nearly 3,800 LF of 12-inch gravity sewer and appurtenances to serve a new industrial user on US Highway 79 near Guthrie, Kentucky, all within Todd County; all as described by the Contract Drawings and Specifications.

1.2 Patented or Proprietary Materials

This Solicitation specifies requested items. It is not the intention of this Solicitation to eliminate Manufacturers or Contractors of similar or equal equipment of the types specified. It should be noted, however, that these requested items are written around specific requirements and needs of the Owner.

Section 746 of Title VII of the Consolidated Appropriations Act of 2017 (Division A - Agriculture, Rural Development, Food and Drug Administration, and Related Agencies Appropriations Act, 2017) and subsequent statutes mandating domestic preference applies an American Iron and Steel requirement to this project. All listed iron and steel products used in this project must be produced in the United States. The term "iron and steel products" means the following products made primarily of iron or steel: lined or unlined pipes and fittings, manhole covers and other municipal castings, hydrants, tanks, flanges, pipe clamps and restraints, valves, structural steel, reinforced precast concrete, and construction materials. The de minimis and minor components waiver apply to this contract.

The Bidder/Contractor shall submit Manufacturers' Certification letter of compliance with Section 746 of Title VII of the Consolidated Appropriations Act of 2017 (Division A - Agriculture, Rural Development, Food and Drug Administration, and Related Agencies Appropriations Act, 2017) and subsequent statutes mandating domestic preference for all equals or substitutes approved by Addenda for American Iron and Steel products as provided in these Contract Documents.

If discrepancies or ambiguities are found in the plans, specifications, contract documents or in any communication to the contractor regarding specified materials not compliant with the American Iron and Steel requirement, the contractor shall immediately notify the Engineer in writing.

2.0 CONTRACTOR'S DUTIES

2.1 Construction and Related Activities

The Contractor shall provide and pay for all labor, materials, equipment, machinery, tools, superintendence, insurance, bonds, shipping, sampling and testing, utilities, and other costs required for a complete and functioning sewer system installation.

2.2 Taxes

The Contractor shall pay all required sales taxes, payroll taxes, consumer and use taxes, and other taxes relating to the work of the project.

2.3 Permits

The contractor shall secure and pay for all legally required permits, licenses and fees associated with the construction.

2.4 Notices

The Contractor shall provide all required notices, including notices to utility owners of intent to excavate in

the vicinity of their utilities, notices to property owners of intent to enter their property for construction purposes, notices regarding the interruption of any utility service, as well as other notices required by the plans and contract documents.

2.5 Laws

Contractor shall fully comply with all applicable laws, ordinances, rules, regulations, orders and other legal requirements, and shall bear the cost of such compliance.

2.6 Character of Workmen

Contractor shall employ workman and foremen with sufficient knowledge of and experience in the type of work proposed to assure satisfactory performance. Workman shall maintain a professional demeanor and appearance at all times on the project. Any workman on the project who performs work in an incompetent manner, or acts in a disorderly or intemperate manner shall be removed from the project, and may not be employed on any portion of the project unless approved by the Owner.

2.7 Notice of Discrepancies

If discrepancies or ambiguities are found in the plans, specifications, contract documents or in any communication to the contractor, the contractor shall immediately notify the Engineer in writing. Do not proceed with the affected work until clarification is received.

2.8 Inspection

Provide at all times, access to the work for inspection by representatives of the Owner, the Engineer, and regulatory authorities having jurisdiction over the project.

3.0 CONTRACTOR'S USE OF PREMISES

The KY Highway 346 & US Highway 79 intersection area of Guthrie, Kentucky (Todd County), is the site of all work on this Project.

- a. **RIGHTS-OF-WAY AND EASEMENTS:** The Contractor has legal authority to construct these facilities on property owned by either the City of Guthrie, Todd County Road Department or Kentucky Transportation Cabinet, within easements on private property, and on existing public rights-of-way and will provide any other required permanent and construction easements for the pipeline. Access to the site of the work is the responsibility of the Contractor. Contractor shall confine his operations to right-of-ways, easements and property obtained by the Owner for construction of the project, or to areas secured by the Contractor for his use. Contractor shall take precautions to minimize disruption to existing properties.
- b. **LOCATION OF TEMPORARY FACILITIES:** Material Storage Buildings, Material and Equipment Storage Yards, and parking areas for all project workers shall be provided by the Contractor, and located in areas approved by the County. Stored materials, regardless of their location shall be protected by the Contractor from damage, theft or degradation at all times.
- c. **DAMAGE TO EXISTING PROPERTY:** The Contractor will be held responsible for any damage to existing structures, work, materials, or equipment because of his operations and shall repair or replace any damaged structures, work, materials, or equipment to the satisfaction of, and at no additional cost to the City of Guthrie.

The Contractor shall protect all existing structures and property from damage and shall provide bracing, shoring, or other work necessary for such protection.

4.0 EXISTING FACILITIES

4.1 Existing Utilities

The existing water distribution and gas system will be in continuous operation during the construction of

the Project. Contractor shall avoid disturbing existing water facilities, and any other utilities or structures encountered in the work, except as necessary for construction operations. Contractor shall give at least 48 hours prior notice to any affected utility or other entity, of any necessary disruptions to service, or work affecting active lines. The Contractor shall be responsible for any necessary damage repair resulting from his installation work

Contractor shall cooperate with affected Utility Company personnel in continuing operation of existing facilities.

4.2 Existing Connecting Streets, Roads and Highways

Any damage to a public facility and/or any access road into the project site by construction traffic generated by this project shall be the responsibility of the Contractor. All streets and roads shall be kept open to normal traffic and in a reasonable state of repair. The Contractor shall arrange with the appropriate authority to perform repairs himself or to have the said authority perform them. Any damages to public roads shall be considered a matter of the Contractor's or his suppliers' public liability, and needed repairs shall be made as required by the public entity having authority over the road.

Contractor shall provide adequate barricades, warning signs, flagmen, lights, etc., for construction operations hazardous to traffic and public safety.

5.0 PARTIAL OWNER OCCUPANCY

The City of Guthrie may, at his discretion, place into service any or all portions of the completed work prior to final completion of all work on the project. Placing a portion of the work in service before final completion does not relieve the contractor of his obligation to complete all work associated with that portion of the line (i.e. clean-up, surface restoration, etc.), to perform maintenance for the required period, or to provide warranty for that portion of the work. If a portion of the work that is placed in service prior to final project completion and acceptance is, in the opinion of the Engineer, complete and ready for acceptance, the Contractor may request that the warranty period for that portion of the work begin at the time it is placed in service, providing that such request is made in writing within seven days of the date of being placed in service. If the request is not made within the required time, the warranty period for that portion of the work will begin upon final acceptance of the Project.

6.0 TEMPORARY FACILITIES

- a. **PARKING:** The Contractor shall provide and maintain suitable parking areas for the use of all construction workers and others performing work or furnishing services in connection with this Contract, as required to avoid any need for such personnel to park personal vehicles in locations where they may interfere with public traffic, City of Guthrie's operations, or construction activities. Securing the use of property for parking areas as necessary for the Contractor's operations shall be the full responsibility of the Contractor.
- b. **SANITARY FACILITIES:** The Contractor shall provide and maintain sanitary facilities for the use of his employees or any other persons on the job site, as may be required to comply with the regulations of state and local departments of health.
- c. **CONTRACTOR'S OFFICE AT SITE OF WORK:** Contractor will not be required to provide temporary office facilities, but may do if desired.

7.0 TEMPORARY UTILITIES & SERVICES

- a. **WATER:** Water for any purpose will be paid for by the Contractor.
- b. **POWER:** Power for lighting, temporary office facilities, operation of the Contractor's plant or equipment, or for any other use by the Contractor shall be provided by the Contractor at his sole cost and expense. The contractor will be responsible for all necessary arrangements with the utility company.

- c. HEAT: All heat necessary for the protection or completion of the work, operation of the Contractor's plant or equipment, or for any other use by the Contractor shall be provided by the Contractor at his sole cost and expense.
- d. TELEPHONE SERVICE: The Contractor shall make all necessary arrangements with the telephone utility, and pay all charges therefore, for telephones in his offices at the site, if desired.
- e. SANITARY SEWER: The Contractor may make use of portable toilet facilities at his sole cost and expense.

8.0 WORKING HOURS

The Contractor may work on this project during the daylight hours, Monday through Friday, except legal holidays, when weather conditions permit. If the Contractor wishes to work at other times, he may do so if approved by the Engineer and if the request to do so is made at least 48 hours in advance.

END OF SECTION 01-100

SUBMITTALS

1.0 PROGRESS MEETINGS

The Contractor shall provide upon request a representative to attend regular City Council meetings to report on project progress and to respond to questions from the Council and the public. The Contractor shall attend other project related meetings from time to time as designated by the Engineer.

2.0 SHOP DRAWINGS, PRODUCT DATA AND SAMPLES

2.1 General

Submit six copies of all required shop drawings to the Engineer for approval. Do not proceed with work involving any material, supply or method subject to review until approved submittals are received. Allow two weeks for Engineer's review.

2.2 Submittal Requirements

Submittals shall fully describe the item, material, or construction method proposed, and shall be free of extraneous materials. Submittals shall be adequate to fully document compliance with all requirements of the specifications. Any proposed deviation from the specifications, and the reason therefore shall be noted on the submittal.

By submitting a particular item, material or method, the Contractor states his intention to use that item, material or method exclusively in the work. Once approved, the Contractor may not change items, materials or methods without resubmitting shop drawings. The Engineer reserves the right to reject a re-submittal solely on the basis of maintaining continuity in the work.

Engineer's review of the submittal does not relieve the Contractor of his responsibility to fully comply with all requirements of the Contract Documents.

Shop drawings returned for correction or rejected shall be revised and resubmitted until final approval is granted. No claim will be allowed for damages or time extension because of delays in the work resulting from rejection of submittals not conforming to the specifications.

2.3 Items Requiring Review

Shop drawing submittal and review are required for, but not limited to, the following items (except where such items are supplied by the owner):

- a. PVC/ Ductile iron pipe & fittings (Gravity Sewer, Force Main, & Service Line Pipe)
- b. Pipe Certifications and Test Results.
- c. Manholes
- d. Aggregates used as bedding or backfill (source and gradation).
- e. Tracer wire/tape and Tracer wire splice kit material.
- f. Pipeline markers.
- g. Casing Pipe
- h. Casing End Seals & Spacers

3.0 CLOSEOUT

Before final payment on the project, deliver to the Engineer the following items.

1. Notarized release of liens from all subcontractors, equipment and material suppliers.
2. Written warranties and guarantees.
3. Testing results as outline in Section 02-190.

4. As-built drawings. (Marked-up set of construction drawings showing actual line location, including tracer wire splices, and any deviations from the plans. These drawings will be separate from those notes and measurements made by the resident inspector.)

END OF SECTION 01-200

MATERIALS PURCHASED DIRECTLY BY OWNER

1.0 GENERAL

The OWNER will purchase certain materials directly from the Vendor in order to take advantage of sales tax savings. For those materials, the Contractor will be responsible for negotiating on behalf of the Owner the purchase price, delivery arrangements, payment terms and all other details of the transaction with a materials vendor of his choosing, as long as the materials purchased comply fully with the Specifications, and the terms do not conflict with the requirements set forth herein.

2.0 PRODUCTS

The Owner shall purchase directly sewer line pipe (DIP or PVC), and casing pipe. The Bidder's unit price for installation of such pipeline, casing pipe, and/or structure shall include all costs of materials necessary for a complete installation, but it shall EXCLUDE sales tax for the materials specified as follows:

- a. Ductile iron pipe.
- b. PVC pipe (if applicable)
- c. Steel casing pipe.

All other materials required for the Project are to be purchased and supplied by the Contractor, and will be subject to applicable taxes.

3.0 PROCEDURE

The following procedure shall be used for materials purchased directly by the Owner.

3.1 Negotiations with Vendors

The Contractor shall negotiate on the behalf of the Owner the purchase price, delivery arrangements, payment terms and other details of the purchase transaction with a vendor of his choosing, provided the materials fully comply with the Specifications, and the payment terms do not conflict with the requirements set forth in this Specification, and all such negotiated terms meet with the approval of the Owner.

3.2 Bidding

The Contractor shall include the name of the vendor(s) and separate materials pricing for those items to be purchased directly on the place designated on the Bid Form. All bonds shall be for the total amount of the bid price including the cost of those materials to be purchased directly by the Owner.

3.3 Request for Purchase Order

Once the purchase transaction is arranged, the Contractor shall complete an Authorization for Purchase Order form (supplied by Owner) and submit it to the Owner. The Request for Purchase Order shall set forth the quantities of materials to be purchased, the purchase price, and all other terms of the proposed purchase agreement. By submitting the Request for Purchase Order, the Contractor represents that the materials will fully comply with the Specifications, and are acceptable to him for use in the Project. The Owner's Engineer will review the Request for Purchase Order and, if acceptable, arrange the issuance of a Purchase Order directly from the Owner to the Vendor with the purchase terms negotiated by the Contractor. Allow 30 days for the issuance of the Purchase Order after the Owner's receipt of an acceptable Request for Purchase Order.

3.4 Review of Submittals

The requirements for review and approval of shop drawings, materials specifications and other submittals set forth in Section 01-200 remain in full effect for items purchased directly by the Owner.

3.5 Delivery of Materials

All arrangements for delivery of materials purchased directly by the Owner shall be made and coordinated by the Contractor. The Contractor shall provide all services pertaining to expediting of orders, receipt, unloading and storage of materials, transport of materials to their point of use in the Project, and protection of the materials during storage. The Contractor shall provide insurance coverage for the materials commencing at the time of their delivery by the Vendor.

The Contractor shall keep a written record of the quantities and timing of delivery of all materials. The Contractor shall inspect the materials promptly upon delivery and provide the Engineer and Construction Supervisor with copies of his delivery reports on a timely basis.

3.6 Payment

After materials are delivered in satisfactory condition, the Vendor may present an invoice for the materials in accordance with the terms set forth in the Purchase Order. Vendor should allow 30 days for payment after acceptance and approval of the invoice. A copy of the invoice will be transmitted to the Contractor for his review and approval. Payment will not be made to the Vendor without written approval of the invoice by the Contractor.

3.7 Adjustment of the Contractor's Payment

The Contractor's respective unit price bid items are to include the cost of materials, excluding sales tax, purchased directly by the Owner in the same manner as if the Contractor were purchasing the items himself. As the materials are incorporated in the work, the cost of those materials used will be deducted from the payment due the Contractor. At completion of the work, the Owner may elect to retain all, part, or none of any materials purchased directly by the Owner. The cost of any materials not retained by the Owner will be deducted from the final payment due the Contractor, and those materials shall become the property of the Contractor.

3.7 The Contractor retains full responsibility for performance of the materials and of the completed pipeline system, and for the required warranty of the work.

END OF SECTION 01-210

CONSTRUCTION LAYOUT AND RECORD DRAWINGS

1.0 WORK COVERED BY CONTRACT DOCUMENTS

The work to be performed involves all survey, calculations and measurement work for providing layout and staking of the construction work to be performed, and as-built survey and documentation of the finished work.

2.0 QUALIFICATIONS OF THE SURVEYOR

2.1 All work performed under this section shall be performed by or under the supervision of a Land Surveyor actively licensed to practice in the state in which the work is to be performed.

2.2 The Land Surveyor shall maintain the following insurance coverages for the duration of the work.

| <u>Coverage</u> | <u>Minimum Coverage Limit</u> |
|------------------------|-------------------------------|
| General Liability | \$1,000,000 |
| Professional Liability | \$1,000,000 |
| Commercial Auto | \$1,000,000 |
| Workers Compensation | Statutory Limit |

2.3 Contractor shall submit for approval the name of the surveyor, evidence of professional licensure, a summary of the surveyor's professional experience relevant to the Project, and evidence of the required insurance in accordance with Section 01-300 prior to the performance of any work under this section.

3.0 PRIMARY PROJECT CONTROL

2.1 The Engineer has established primary project control points for use in design of the Work. These control points are noted on the Drawings. No additional control points will be set by the Engineer.

2.2 The Contractor's surveyor shall locate all primary control points and perform such measurements as may be required to confirm that no primary control point has been disturbed. In the event that any primary control point is missing, destroyed, or suspected of being disturbed, the Engineer shall be promptly notified.

3.0 LOCATION ACCURACY

3.1 The pipeline shall be installed at the horizontal location shown on the project plans, and at a depth as indicated on the plans. The horizontal centerline location of the installed pipeline shall not vary more than +/- 2 feet from the required location. The vertical location of the installed pipeline shall not vary more than +6 inches/-1 foot, provided that the depth of cover of the installed pipeline may not be less than 42 inches in any case.

3.2 Deviations outside of the required location accuracy shall be approved in advance by the Engineer.

3.3 Unapproved deviations from the required location accuracy shall be corrected at the Contractor's expense.

4.0 CONSTRUCTION STAKING

4.1 All project control in excess of the primary project control initially established by the Engineer shall be provided by the Contractor's surveyor.

4.2 All layout and staking required for construction of the Work shall be provided by the Contractor's surveyor.

4.3 Staking and layout work shall be performed by competent and experienced personnel using equipment as required to achieve accurate results. Precision of the survey work shall be consistent with industry standards for similar work.

4.4 After verification of the integrity of the primary project control, the Contractor will be responsible for replacing

any control points or staking lost as a result of construction operations, vandalism, tampering, or other occurrences.

4.5 The Contractor's surveyor shall be responsible for establishing lines and grades to assure that the work is constructed according to the project plans, and to locate property boundary lines, easements, etc. as required to assure that the work is constructed within or upon the appropriate property or easements.

4.6 The Engineer will provide project drawings and right-of-way drawings in AutoCAD format for the construction surveyor's use.

5.0 RECORD DRAWINGS

5.1 The Contractor's surveyor shall prepare an as-built survey of the completed work. The survey shall locate project features (e.g. valves, fittings, meters, structures, casings, etc.) in three dimensions relative to the primary project control. Buried pipelines shall be located in three dimensions at each change of direction, at an interval not exceeding 300 feet along straight runs, and at an interval such that the actual location of the pipeline shall not vary by more than 1 foot at any point along the chord resulting from a straight line connecting two location points.

5.2 An overlay record drawing shall be produced in AutoCAD format showing the as-built locations surveyed. An electronic file and one paper copy of the record drawing survey shall be submitted to the Engineer.

END OF SECTION 01 900

GRAVITY SEWER GENERAL REQUIREMENTS

1.0 GENERAL

1.1 Scope of Work

The sewer mains and appurtenances required on this contract shall be furnished in full compliance with the contract specifications and contract drawings.

Work to be performed under the unit price items, described subsequently herein, shall include for each item all excavation (including rock excavation, if any) the removal of existing pavements, curb and gutter, sidewalks, driveways, brush and timber, structures and piping to be relocated or abandoned; also sheeting, diking, well pointing, bailing, dewatering; the furnishing, placing and removal of bulkheads, the restoration of any utilities, parkways, trees, shrubbery, culverts, fences and other items disturbed by construction operations; backfilling and removal of excess excavated materials; and testing.

The cost of all such work and the cost of other work necessary for the complete sewer line installation shall be included in the unit price pay items provided.

1.2 Standards

Where materials and methods are indicated in the Specifications as being in conformance with a standard specification (i.e. AWWA, ASTM, etc.) it shall refer in all cases to the latest edition of the specification or standard, and shall include all interim revisions. Listing of a standard specification without further reference shall indicate that the particular material or method shall conform to the referenced specification.

2.0 WORK INCIDENTAL TO CONSTRUCTION

Work to be performed under this heading includes all the work designated as "incidental to construction" and other work required by the plans, specifications or contract documents in order to fully complete the work on the project, but not provided with a specific pay item in the bid form. The contractor shall perform such work, and the contractor shall include all charges for the work in the bid items provided. No claim for additional compensation based upon required work not being described in a bid item will be considered.

2.1 Public and Private Utilities

Where **any** utilities (including those of the City of Guthrie), such as water, sewer, telephone, power, oil or gas transmission, or any other, either public or private are encountered, the contractor shall provide adequate protection for them and will be held responsible for any damage to such utility from his operations. When it is apparent that construction operations may damage the integrity of any utility conduit or pole, or the support of any structure, the contractor shall notify the utility owner of this possibility and shall take such steps as may be required to provide temporary bracing or support of the affected conduit, pole or structure.

The cost of any bracing or support of conduits, poles or structures encountered in the work shall be included in the bid item for sewer main construction.

When, in order to carry out the work, a pole, conduit or structure is required to be removed or relocated, the contractor shall be responsible for making all arrangements with the utility owner for such removal or relocation. All costs for such relocation or removal shall be born by the contractor unless it could not be reasonably foreseen that such work would be required.

All damage to utilities resulting from the contractors operations shall be repaired at the contractor's expense. Where it is the policy of the utility to perform their own repairs to damaged utilities, the contractor shall cooperate fully with the utility and bear the costs of such repairs.

2.2 Existing Water, Sewer and Drain Facilities

In some instances, existing water, sewer or drains may be encountered along the line of work. In all such cases, the contractor shall perform his operations in such manner that the service will not be interrupted, and shall, at his expense, make temporary provisions to maintain such services.

Where it is necessary to cut, remove and/or replace existing storm sewers and drain tiles, the Contractor shall make specific arrangements to maintain the flow of water and shall not place permanent bulkheads in any conduit. Temporary earth dams may be used to confine and/or channel the flow and shall be removed upon completion of the crossing.

The Contractor shall receive no extra compensation for replacement of drains encountered or for relaying same at a new grade or line. Where existing water mains are encountered in the work they shall be maintained in operation to the extent that water service is not interrupted.

2.3 Existing Gas, Electric and Other Facilities

Where existing gas mains are encountered, the Contractor shall arrange with the Gas Utility for any necessary location and relaying.

The Contractor will give adequate notice to the Gas Utility to allow their location of gas lines ahead of the proposed construction with paint or stakes. The Contractor will be required to expose the gas mains prior to dynamiting and excavation, where crossing pipeline installations. Track drill operations will be ceased short of the gas main and will resume on the other side of the main. The material under the gas line will be removed with hand drills and/or jack hammers. The Contractor shall contact the Gas Utility for restrictions on blasting in the vicinity of the gas line, comply therewith.

Before backfilling a trench in which a gas main has been exposed, the Contractor shall notify the Gas Utility to inspect the exposed main and perform any protective measures deemed necessary.

The forgoing provisions pertaining to gas lines shall apply to all natural gas, petroleum and other pipelines.

Where existing underground electric or telephone facilities are encountered, the Contractor shall take the necessary measures to work around the facilities or arrange with the Electric Company or Telephone Company for any necessary relaying. Repairs made necessary by damage to any facilities by the Contractor shall be charged to the Contractor.

2.4 Dewatering

The Contractor shall perform all pumping, well pointing, ditching and any other necessary procedure to keep the excavation clear of groundwater, storm water, or sewage during the progress of the work and until the completed work is safe from injury.

The Contractor shall maintain dewatering operations such that no groundwater, storm water, or sewage will be allowed to build up over any concrete and/or masonry at manholes or structures for a period of 6 hours.

All water pumped or drained from the work shall be disposed of in a satisfactory manner without damage to adjacent property or to other work under construction. The contractor shall not dispose of storm or surface water through sanitary sewerage facilities.

It shall be the Contractor's responsibility to take all necessary precautions to protect all construction against flooding and/or flotation from hydrostatic uplift.

All dewatering procedures and maintenance thereof shall be considered an incidental part of pipe laying and construction operations and no separate payment will be allowed therefor.

Dewatering operations for structure construction shall be such that the groundwater or surface water is not being pulled over, around, or through the freshly placed concrete or masonry. The use of multiple pumps in the trench may be required. When required to protect the freshly placed concrete and/or masonry, timber or plywood forms will be positioned around in the concrete or masonry so that the dewatering operations will not cause a separation of cement and aggregate. The cost of these dewatering and/or protection procedures shall be merged into the appropriate bid items.

2.5 Barricades And Warning Signs

The Contractor shall furnish, erect, and maintain such barricades, fences, lights, and danger signals and take other precaution measures that will insure the protection of persons, property and the work.

2.6 Maintenance and Access of Traffic

Portions of the work are located in developed areas requiring the access for fire and other departments to be provided for at least one free lane be available for all traffic. Contractors are to arrange operations in these areas to meet these requirements and secure approval of operating procedures from the Guthrie Street Department, Todd County Road Department or the Kentucky Department of Highways as appropriate.

Where sewer mains are constructed under paved roadway surfaces, within public right-of-ways, the Contractor will restore the asphalt or crushed stone pavement and/or shoulders between shoulder lines. It shall be the responsibility of the Contractor, upon completion of the installation, to regrade the street to the template that existed prior to construction. This regrading shall be satisfactory to the Guthrie Street Department, Todd County Highway Department or the Kentucky Department of Highways.

The Contractor shall further be responsible for the maintenance of disturbed streets until re-paving operations have been completed.

The Contractor shall restore all curbs, gutters, sidewalks, ramps and private driveways or parking lots. This work shall be considered as incidental to the construction of the proposed sewer main and, therefore, no additional compensation will be allowed for the restoration of these items.

The Contractor shall also be required to restore, at his own expense, all pavements disturbed by his operations where the sewer main was not constructed under the pavements. He shall further be required to replace at his own expense all pavements disturbed in the correction of sewer main deficiency discovered after restorations have been completed.

3.0 MATERIAL AND EQUIPMENT

Materials, products and equipment shall be properly containerized, packaged, boxed and protected to prevent damage during transportation and handling. Provide suitable temporary weather tight storage facilities as may be required for materials or equipment which will be damaged by storage in the open. Protect from damage all materials delivered at the site. Do not use damaged material on the work.

Manufactured articles, materials and equipment shall be applied, installed, connected, erected, used, cleaned and conditioned as directed by the respective manufacturers unless directed otherwise by the provisions of these Specifications.

4.0 SPECIAL CONDITIONS

The Contractor's attention is called to the special conditions (i.e. road crossings, construction in road right-of-way, etc.) indicated on the Plans. The Plans and Specifications reflect the type of construction that is anticipated in the various locations requiring special attention, but it shall be the responsibility of the Contractor to contact the various agencies including the State Highway Department, the Gas Company, Telephone Company, Corps of Engineers, and other utilities and/or entities involved when working in areas where they will be concerned, and for coordinating construction with their requirements in such a way to avoid conflicts, damage or interruptions in service.

- (a) The Contractor shall perform his work in such a manner that normal service on existing water lines and service to customers is maintained to the maximum extent possible. Such service shall be disrupted only at times and in such a manner as approved by the Utility's Engineer.
- (b) The Contractor shall submit a work schedule to the Utility/Owner for approval prior to beginning work. The schedule shall establish the planned sequence of line installation, service switch-over if required and property restoration for the project.
- (c) The Contractor shall maintain access to businesses and residences to the maximum extent possible.
- (d) Easement Restrictions - The Contractor shall exercise due care in staying within the easements obtained for the proposed construction, and will be held strictly accountable for violations thereof. Any additional access to or use of private property must be arranged by the Contractor, at his expense, by negotiation with the property owner involved.

The Contractor's attention is also called to the special conditions associated with the proximity of the Owner/Utility's existing water distribution system in relation to improvements indicated on the Plans. The proposed improvements will be constructed adjacent to and/or may encounter existing water lines which must remain in service until the successful testing and completion of the proposed improvements. The Contractor is reminded of paragraph 2.1 of Section 02-100, and the Contractor is urged to use the most appropriate construction measures to produce a suitable finished product while maintaining the integrity of the existing infrastructure.

5.0 TESTING

The Specifications for materials designate the testing applicable for materials incorporated in the work. Testing shall be done by the manufacturer in accordance with the applicable ASTM specification. Manufacturer shall furnish the Engineer with three (3) certified copies for the test results.

The Utility/Owner may, at his option, elect to have an independent testing laboratory test materials to be furnished for incorporation in the work. Such testing, when done, shall be in accordance with provisions of the Specifications for Materials.

Acceptance testing for installed sewer line will be limited to visual testing and pressure testing unless directed otherwise by the Utility/Owner's Engineer.

6.0 SUBMITTALS

Submittals for this work include, but are not limited to, those items listed in Section 01-200. Provide at least six copies of each submittal, and allow two weeks for the Utility/Owner's Engineer review. Such submittals are to be approved by Utility/Owner's Engineer prior to incorporation of any materials into the work.

7.0 WARRANTY

The work to be performed under this Contract shall be guaranteed against defects in materials or workmanship for a period of one year following the date of formal acceptance of the project. In the event defects in materials or workmanship should appear, the Contractor shall promptly make the necessary correction. When the defects are not of an emergency nature, The Contractor will be notified and will be given a period of two weeks in which to make the necessary corrections. Should the defect be of an emergency nature, which in the opinion of the Utility/Owner requires immediate correction, the Contractor will be notified and requested to make the necessary repair immediately. Should this be impractical, or if the Contractor should fail to respond to the request for corrective action within the specified period, the Utility/Owner may proceed to have the defects corrected and shall bill the Contractor for all charges in connection therewith including labor, materials, and equipment rental. Such charges may be deducted from amounts due the Contractor if any of the Contractor's money has been withheld. In the event the Contractor fails, refused, or neglects to pay the Utility/Owner, the Surety shall be liable for such charges.

8.0 MAINTENANCE OBLIGATION

The Contractor shall be fully responsible for maintenance of any and all portions of the work, which he performs under this Contract for a period of 30 days. This maintenance obligation shall begin upon formal acceptance of the project and is intended to place a limit upon the Contractor's responsibility for normal maintenance required for the routine operation of the system. This 30-day obligation shall not be construed as relieving the Contractor of the responsibility for maintenance or repair work resulting from defective materials or workmanship during the warranty period.

9.0 PROJECT CLOSEOUT

The premises and the job site shall be maintained in a reasonably neat and orderly condition and kept free from an accumulation of waste materials and rubbish during the entire construction period. Remove crates, cartons and other flammable waste materials or trash from the work areas at the end of each working day.

When the Contractor requests a final inspection, the Utility/Owner and/or its representatives will inspect the work for completeness in accordance with the Contract Documents. The contractor shall promptly correct any deficiencies.

Final acceptance cannot be made until the Contractor furnishes to the Utility/Owner a notarized certification in a form suitable to the Utility/Owner that all labor and material costs for the work have been paid by the Contractor and that there are no liens against the work.

END OF SECTION 02-100

CLEARING, GRUBBING AND STRIPPING

- 1.1 SCOPE OF WORK: The work to be performed under this section includes all clearing, grubbing, and stripping necessary to properly prepare the project area on which work is to be done according to plans and specifications. Scarifying of all areas specified or shown on the plans to receive backfill, pavement and other construction shall be performed in accordance with the applicable sections.
- 2.1 MATERIALS AND EQUIPMENT: The Contractor shall use equipment and/or materials necessary to accomplish the intent and work described herein in an efficient and complete manner.
- 3.1 CLEARING AND GRUBBING: Areas to be excavated or on which fills are to be placed shall be cleared of trees, down timber, brush, rubbish, debris and other objectionable material. Other areas designated to be cleared of underbrush shall be cleared of all trees under 6-in. caliper except as directed by Engineer.

Grubbing of roots within limits of excavation and fill operation shall consist of removal of stumps and roots having diameter larger than 3 inches so that no part shall extend nearer than 18 inches of finish construction subgrade.

In areas of partial clearing (underbrush only) remove roots, stumps and other impediments sufficiently to permit light disking of soil for lawn seeding.

In areas to receive paving, walks or structures, all stump holes or other excavation below subgrade shall be filled with selected earth fill and compacted to 95% of maximum density at optimum moisture.

The contractor shall be responsible for cutting and removal of any trees, brush, stumps, roots, and weeds within the construction easement as required for installation of the work. Contractor shall remove only those trees that are required to perform the work, and shall avoid removal of or damage to mature trees to the greatest extent possible. Any marketable logs generated by the removal of mature trees shall be made available to the landowner. Limbs, brush and other cut debris shall be mechanically chipped and spread as mulch on the easement within the disturbed areas within 7 days of cutting. All other materials shall be disposed of by means of mechanical chipping, landfill disposal, or other approved methods not in conflict with Federal, State or local laws, ordinances or regulations. No brush or debris may be burned on site. No intact brush, trash, debris or large rock may be left on the easement, even if approved by the landowner.

- 3.2 STRIPPING: In all areas where construction of any type is to be performed, the top 2 inches of soil shall be stripped off and salvaged. This material may be used for top soil dressing on side slopes of swales, ramps, and yard areas.
- 3.3 REMOVING MATERIAL: Unless otherwise specified, cleared and grubbed material becomes property of the contractor, to be removed from the work site or disposed of in manner not to damage the owner.

END OF SECTION 02-102

GRAVITY SEWERS

1.0 SCOPE

The work under this Section includes the furnishing, installing and/or laying, jointing, and testing of all gravity sewer lines, manholes, fittings, and appurtenances, including necessary service connections, required for a complete system as shown on the drawings and specified herein. It shall be also include such connections, reconnections, temporary service and all other provisions in regard to existing sewer operations and modifications required to perform the new work. The unit price bid for the various pay items shall include earth and/or rock excavation. It is the intent of this specification that all items shall be furnished and installed complete to the Engineer's satisfaction as specified.

2.0 GENERAL REQUIREMENTS

- 2.1 All work shall be proved to be in first class condition and constructed properly in accordance with the drawings and specifications. All defects and leaks disclosed by the tests shall be remedied, All tests shall be performed by the Contractor and observed by the Engineer. Water, gauges, and equipment required for testing will be furnished by the Contractor.
- 2.2 Shop drawings and catalog data will be required for the following items included in this Section. Refer to Section 01-200 for submittal procedure. Individual submittals for each size of pipe, manhole, etc., will be required, unless so directed by the Engineer.

Pipe, fittings and joints
Manholes
Manhole frames and covers

- 2.3 The Contractor shall submit to the Engineer for approval before work begins, certificates of inspection from the pipe manufacturer that the pipe and fittings supplied have been inspected at the plant and meet the requirements of these specifications.
- 2.4 All pipe and fittings shall be clearly marked with the name or trademark of the manufacturer, the batch number (iron pipe only), the location of the plant and strength designation.

3.0 MATERIALS

- 3.1 General - All material shall be free from defects impairing strength and durability and be of the best commercial quality for the purpose specified. It shall have structural properties sufficient to safely sustain or withstand strains and stresses to which it is normally subjected and be true to detail. Where reference is made to American Society for Testing and Materials (ASTM) Specifications or American National Standard Institute (ANSI), requirements of the latest revision or edition shall apply. Where ASTM Specifications or ANSI Standards conflict with these specifications, the more stringent specification shall apply unless specifically noted otherwise.
- 3.2 Polyvinyl Chloride (PVC) Gravity Sewer Pipe and Fittings - PVC pipe and fittings shall conform to ASTM D-3034, and shall be of bell and spigot construction. Standard lengths shall be 20 ft. and 12.5 ft. ± one inch. All fittings and accessories shall have bell and spigot configurations identical to that of the pipe. Minimum pipe stiffness ($F/\Delta y$) at 5% deflection shall be 46 for all sizes when tested in accordance with ASTM D-2412. Minimum wall thickness shall conform to requirements of SDR 35.
- 3.2.1 Joints - The pipe bell shall consist of an integral wall section with solid cross section elastomeric ring factory assembled and securely locked in place to prevent displacement. The integral bell gasketed joint shall be designed and manufactured so that when assembled, the elastomeric gasket inside the bell is compressed radially on the pipe spigot to form a positive water tight seal. The joint shall be so designed, manufactured, and installed to avoid displacement of the gasket.

- 3.2.2 Transition From PVC Pipe to Manhole - A suitable coupling, with a rubber ring seal against the pipe, shall be used in each manhole entry to insure a surface for adherence, when the pipe to manhole connection is grouted in place to provide a watertight seal.
- 3.2.3 Certification - Acceptance of the material shall in part be based on the receipt of a written certification. This certification shall consist of a copy of the manufacturer's test report or a statement by the seller, accompanied by a copy of the test results, that the material has been sampled, tested, and inspected in accordance with the provisions of ASTM D3034. Each certification so furnished shall be signed by an authorized agent of the seller or manufacturer. The contractor shall secure this certification from the manufacturer and furnish same to the Engineer.
- 3.3 Ductile Iron Pipe and Fittings - Ductile iron pipe and fittings shall conform to the requirements of ANSI A21.51. All ductile iron fittings shall conform to ANSI A21.10. Pipe thickness shall be determined following the procedure outlined in ANSI A21.50. In any case, pipe thickness shall not be less than Class 50 as noted in Table 50.13 of ANSI A21.50. Ductile iron pipe and fittings not to be painted shall be coal tar coated on the outside. All ductile iron pipe and fittings shall receive a cement lining and bituminous seal coat conforming to the requirements of ANSI A21.4.
- 3.3.1 Joints - All ductile iron pipe and fittings shall have either bell and spigot or flanged joints. Bell and spigot joints shall be mechanical joints or slip joints conforming to the requirements of ANSI A21. 11. Flanged ends shall be faced and drilled for Class 125 flanges, except as otherwise specified or shown on the drawings. The minimum class thickness for ductile iron flanged pipe to be threaded is ANSI A21.51 Class 53.
- 3.3.2 Certification - The contractor shall secure from the manufacturer and furnish to the Engineer a certificate of inspection, sworn to by the factory inspector in the presence of a Notary Public, stating that the pieces of pipe and fittings making up the shipment were manufactured and tested in accordance with applicable ANSI standards. A statement listing all items contained in each shipment, the number of pieces of pipe and fittings in the shipment, the length of each piece of pipe and the weight of each individual item in the shipment shall be attached to the certificate of inspection.
- 3.4 Steel Casing Pipe - Casing joints shall be of fully welded, leak proof construction. The steel casing pipe shall have a minimum yield strength of 35,000 psi and shall have the minimum wall thickness of 0.25 inches for 12" nominal diameter and smaller pipe. Casing pipe larger than 12" shall have a wall thickness corresponding to ASTM standards for Standard Weight steel pipe. Steel casing pipe shall be coal tar protected according to AWWA Standard C203-91 and C209-20. Pipe shall be welded according to AWWA Standard C206-91 unless otherwise specified.
- 3.4.1 Joints - where required, shall be electric-fusion (arc) welded by operators qualified in accordance with American Welding Society Standard Procedure.
- 3.4.2 Casing Vent Pipe will not be required for gravity sewer installations.
- 3.4.3 Casing End Seals shall be heavy duty rubber with stainless steel clamps for attachment to the casing pipe and carrier to form a watertight seal. CCI Model ESW or approved equal.
- 3.4.5 Carrier Pipe Casing Spacers: Casing Spacers shall be of heavy-duty two-piece stainless steel as manufactured by Advance Products or CCI (Model CSS-center restrained) or approved equal. Provide at least four skids equally spaced around the full length of the pipe barrel. Skids shall be of sufficient size to assure that the pipe bell does not contact the casing.
- 3.5 Precast Concrete Manholes - Precast concrete manholes shall conform to the requirements of the ASTM Serial Designation C478, with subsequent revisions. Whenever necessary, barrel sections shall be custom made with openings to meet indicated pipe alignment conditions and invert elevations. The thickness of the wall base section shall conform to details on the drawings.
- 3.5.1 Standard Manholes - The standard manhole will be 3'-0" in depth measured from the base of the cover frame to the invert of the lowest pipe in the manhole. The standard manhole will include a standard frame and cover as specified herein.

- 3.5.2 Concrete - The concrete for use in manhole construction shall conform to requirements for Class B concrete using standard aggregates as set out in Division 3, CONCRETE, of these specifications.
- 3.5.3 Base - The bottom section of the precast manhole shall be placed in a 6 inch bed of Class D concrete. The concrete shall be poured directly on undisturbed soil or upon a prepared granular bedding approved by the Engineer.
- 3.5.4 Joints - Joint contact surfaces shall be joined with an approved non-shrink mortar and/or an approved rubber gasket. Approval shall be given by the Engineer.
- 3.5.5 Inlet and Outlet Pipes - Whenever a sewer enters or leaves a manhole, a short section of pipe shall be used as shown on the manhole detail to reduce the incidence of sheared pipe. The short pipe shall be cradled in concrete extending from the manhole base to the next joint. The concrete cradle and manhole base shall be poured at the same time to ensure that a non-jointed base is formed. Forms shall be used to prevent concrete from protruding under the next section of pipe.
- 3.5.6 Cast Iron Manhole Frames and Covers - A cast iron manhole frame and cover shall be furnished for each manhole and thoroughly grouted in place with non-shrink grout. Castings shall be true to pattern in form and dimensions, free from pouring faults, sponginess, cracks, blow-holes, and other defects that would effect the value for the service intended. The surface of contact of the cover with the frame and the surface of contact of the frame with the cover are to be machined to a plane true surface. Both frame and cover shall be painted in the shop with one heavy coat of a medium hard drying asphalt base paint.
- 3.5.6.1 Standard Manhole Frames and Covers - The standard frame and cover shall be plain "Sewer" No. 1110 Nashville Standard Traffic as manufactured by John Bouchard & Sons Company, or R-1668 as manufactured by Neenah Foundry Company, Neenah, Wisconsin, or equal. The lid shall be solid with no vent holes, and marked "sewer".
- 3.5.6.2 Watertight Frames and Covers - Watertight frames and covers will be required where shown on the plans. Watertight frames and covers shall be No. 1122 Water Tight Nashville Standard as manufactured by John Bouchard & Sons Company, Nashville, Tennessee, or equal. All manhole covers shall be solid, and marked "sewer".
- 3.5.7 Manhole Steps - Manhole steps shall be No. 1800 Nashville Standard as manufactured by John Bouchard & Sons Company, or R-1980-E as manufactured by Neenah Foundry Co., Neenah WI, or equal. The steps shall be made of Class 30 cast iron ASTM Specifications A48-56, resistant to rust and corrosion. After being set they shall be given one coat of approved protective asphalt paint.
- 3.6 Pipeline Detection Tape - Detectable pipeline location tape shall be plastic composition film containing one layer of metalized foil laminated between two layers of inert plastic film specifically formulated for prolonged use underground. Tape shall be a minimum of 5.5 mils thickness and continuously printed in permanent ink to indicate caution for a buried sewer line below. Tape shall be a minimum of 3 inches in width with a minimum tensile strength of 5000 psi. Tape shall be Terra-Tape as manufactured by Reef Industries, Inc., or approved equal.

4.0 PIPE INSTALLATION

- 4.1 General - The method of pipe laying shall be subject to the approval of the Engineer. Each pipe length shall be inspected and tested before being laid. The pipe laying shall proceed upgrade, beginning at the lower end of the sewer, with pipe bell ends upgrade. Extreme care shall be exercised to keep the pipe in exact alignment and elevation. Pipe shall be laid to conform accurately to the lines and grades indicated on the drawings. If approved by the Engineer, minor changes in the alignment but not in the grade will be permitted to avoid underground facilities, provided that straight alignment can be maintained between manholes. In no case shall the pipe be walked on either before or after the joints have been made, Upon discovery, any defective pipe which may have been laid shall be removed and replaced with sound pipe. The contractor shall investigate well in advance of pipe laying any conflicts which may require readjustment in planned locations; and shall advise the Engineer of the results of these investigations so that a determination may be made and instructions given by the Engineer as to any required modifications.

- 4.2 Trenching - Unless otherwise directed by the Engineer, all trenches in which pipes are to be laid shall be excavated in open cut to such depths to allow proper bedding as shown on the plans or otherwise called for in these specifications. The trenches shall be opened to the depths specified by the Engineer. Before laying the pipe, the trench shall be opened far enough ahead to reveal Obstructions. The pipe line shall be straight and uniform and shall be kept at a uniform distance from the offset line as staked by the contractor. A minimum horizontal distance of 10' between sewer and water mains shall be maintained. Where a crossing is required, the sewer shall be a minimum of 18" below the water main.
- 4.3 Obstructions - Materials excavated shall be disposed of so as to interfere as little as possible with public travel, and in all cases the disposition of excavated material shall be satisfactory to the Engineer. In cases where gas, sewer, water or other pipe is encountered, it shall neither be displaced nor disturbed unless necessary, in which case, it shall be replaced in good condition as promptly as possible. All gas, water, storm sewer lines and existing utilities damaged or disturbed in the construction shall be replaced or repaired at the Contractor's expense, unless in the opinion of the Engineer, such damage was caused through no fault of the Contractor. The Contractor shall notify and comply with all rules, regulations and requirements of the respective authority for the replacement and/or repair of all existing utilities which are damaged due to construction.
- 4.3.1 At all street and road crossings, only one-half of such street crossings and road crossings shall be excavated before placing temporary bridges over the side excavated, for the convenience of the traveling public. All temporary bridges, barricades, lanterns, and watchmen by night and such other signs and signals by day, as shall be necessary to warn the public of the damages caused by excavations and other obstructions shall be provided by and at the expense of the Contractor and shall comply with the local highway authority.
- 4.4 Bedding All sewer pipe will be bedded in tamped stone chips in accordance with the details on the drawings and as specified in paragraph 4.5 of this section of these specifications. The cost of these chips will not be a pay item but will be included in the unit price bid per foot for the sewer lines.
- 4.5 Laying and Jointing - The pipe shall be laid on an unyielding foundation with uniform bearing under the full length of the barrel of the pipe. Suitable excavations shall be made to receive the bell of each pipe, which shall be carefully laid true to line and grade. All adjustments to line and grade must be made by scraping away or filling in under the barrel of the pipe and not by wedging or blocking UP of any portion of the pipe. The spigot end of each pipe shall abut against the base of the socket of the adjacent pipe in such a manner that there will be no unevenness of any kind along the bottom halves of the pipes. Just before jointing the pipes, the mating ends shall be thoroughly cleaned of all dirt, debris, and foreign material. The pipe shall be jointed in accordance with the recommendations of the manufacturers of the pipe and gasket. In all jointing operations, the trench must be dewatered when joints are made and kept dewatered until sufficient time has elapsed to assure efficient hardening of the jointing material, or as may be required. The pipe shall not be driven down to grade by striking it with a shovel handle, timber, rammer, or other unyielding object. The Contractor shall take all necessary precautions to prevent flotation of the pipe from flooding of the trench. Dewatering, when necessary, shall be at the Contractor's expense and shall not justify additional pay.

Batterboards, laser beams or methods approved by the Engineer shall be used to assure the proper grade and alignment of gravity sewers. Pipe shall be laid to conform accurately to the alignment and grades indicated on the drawings.

- 4.5.1 Ductile Iron Pipe - Installation of ductile iron pipe shall conform to ASTM C-12, bedding Class C unless specified otherwise on the Drawings.
- 4.5.2 Polyvinyl Chloride (PVC) Pipe - Installation of PVC pipe shall conform to ASTM D-2321, "Recommended Practice for Underground Installation of Thermoplastic Sewer Pipe", except as amended herein. Bedding material for PVC pipe shall be clean, compacted, angular, graded stone (1/4 to 3/4 inches). All bedding material for PVC pipe shall extend from a minimum of 6 inches below the bottom of the pipe to the top of the pipe.

Care shall be taken during compaction with tamping machines that the pipe is not dislodged by "rebound".

PVC pipe shall pass a vertical floating pin type go-no go mandrel (or effective equivalent) sized to 95% of the pipe diameter of the actual pipe used with the pipe in place and covered. The appropriate allowable

deflection when installed (must be less than 5%) may be calculated using the pipe stiffness formula in ASTM D-2321.

- 4.6 Stoppers - Openings such as stubs, tees, or other services along the lines shall be securely closed by means of an approved stopper that fits into the bell of the pipe and is recommended by the pipe manufacturer. This stopper shall be jointed in such a manner that it may be removed at some future time without injury to the pipe itself. At the close of each day's work, and at other times when pipe is not being laid, the end of the pipe shall be temporarily closed with a close-fitting stopper approved by the Engineer. No special payment will be made for stoppers or bulkheads.
- 4.7 Cleaning - All necessary precautions shall be taken to prevent the entrance of mud, sand or other obstructing material into the pipelines. As the work progresses, the interior of the sewer shall be cleaned of all dirt, jointing material and superfluous materials of every description. The Contractor shall flush all sewer lines constructed under this Contract with clean water, prior to final inspection, to assure complete removal of all debris and foreign material, and to the satisfaction of the Engineer. Cleaning work shall be done with care to avoid damage to any interior coating.
- 4.8 Inspection of Lines - Before the Contractor backfills any of the lines they shall first be inspected by the Engineer and the Engineer shall give the Contractor permission to proceed. If any joints or specials in the line are found defective, they shall be removed and replaced by the Contractor without extra compensation.
- 4.9 Backfilling of Sewer Lines - Backfilling shall be started as soon as practical after pipe laying. In the backfilling of the trench, material reasonably free from rock and acceptable to the Engineer shall be used. The granular backfill shall be carefully tamped under and around the lower half of the pipe and to a depth of 6" above the top of the pipe. In filling the remainder of the trench, the backfill material may be shoveled into the trench without compacting and heaped over it wherever, in the judgment of the Engineer, this method of backfilling can be done without inconvenience to the traveling public. The backfilling shall all be done in layers not exceeding 6" and firmly tamped into place by mechanical tampers or rammers where crushed stone roadways and driveways or pavement is to be replaced. Before final acceptance, the Contractor will be required to level off all trenches where backfilled materials have been piled up, or to bring up the trench to grade where necessary; also to remove from the property all excess earth or other material not needed in the work. The Contractor shall not have more than 300' of open trench.

It shall be the responsibility of the Contractor to properly maintain the backfilled ditches in such a manner that they will offer no hazard to the passage of traffic. The Contractor shall take into consideration the convenience of the traveling public and the convenience of the proper abutting the improvements and shall backfill or bridge drives promptly at the direction of the Engineer.

- 4.10 Pipe on Piers - Where sewer pipe crosses a stream or depression, it shall be constructed in accordance with details shown on the drawings. Where piers are required, ductile iron or steel pipe shall be used in not less than 18' lengths or as specified on the drawings.

5.0 SERVICE CONNECTIONS

- 5.1 Types of Connections shall be as described in the proposal. The actual location shall be determined by the Contractor, subject to approval by the Engineer. Each service connection shall be accurately recorded by the Contractor by stationing on the as-built drawings and shall be furnished to the Engineer.

5.2 Sewer Service Pipe Installation

- 5.2.1 All service connection piping shall be extended from the sewer main to a connection point at the residence or structure as required to connect to the sewage plumbing. The intended route of service connection piping is indicated on the Drawings, but the route shown is not intended to be exclusive and may vary as needed. Measurement and payment shall be by linear footage at the unit bid price. Concrete, clay or fibrous type pipe will not be acceptable. Service connection piping termination shall be at a depth no greater than six (6) feet deep.

- 5.2.2 In the event it is necessary to install a service line beneath an existing curb or curb and gutter installation, the Contractor shall tunnel beneath said installation, when so authorized by the Engineer. Any damage

resulting therefrom shall be repaired by and at the expense of the Contractor, unless otherwise agreed to by the Engineer.

- 5.3 Stoppers - If the service line from the area being served is not installed at the time of construction, the opening at the end of the new service line shall be securely closed with an approved stopper that fits into the bell of the pipe and is recommended by the pipe manufacturer. This stopper shall be jointed in such a manner that it may be removed at some future time without injury to the pipe itself.

6.0 MANHOLE INSTALLATION

- 6.1 Installing Sections - Precast concrete sections shall be set so the manhole will be vertical and with sections in true alignment. Joint surfaces of the base or previously set section shall be joined in accordance with paragraph 3.7.4 of this Section.

- 6.2 Non-Shrink Mortar - All holes in sections used for their handling, and the annular space between the wall and entering pipes shall be thoroughly plugged with an approved non-shrinking mortar, applied and cured in strict conformance with the manufacturer's recommendations so that there will be zero leakage through openings and around pipes. The mortar shall be finished smooth and flush with the adjoining interior and exterior manhole wall surfaces.

- 6.3 Grade Adjustment - For grade adjustment in setting the manhole frame, brick masonry shall be used on top of manhole slabs and precast concrete manhole cones in accordance with the drawings. Mortar shall be one part cement and two parts sand; lime shall not be used.

- 6.4 Setting Manhole Frames - Manhole frames and covers shall be set to conform accurately to the finished ground or pavement surface as established by the Contract Drawings, unless otherwise directed by the Engineer. Frames on manhole cones shall be set concentric with the masonry and in a full bed of mortar so that the space between the top of the manhole masonry and the bottom flanges of the frame shall be completely filled and made watertight. A ring of mortar at least four inches thick and pitched to shed water away from the frame shall be placed around the outside of the bottom flange. Mortar shall extend to the outer edge of the masonry and shall be finished smooth and flush with the top of the flange. Watertight manhole frames shall be set as recommended by the manufacturer.

- 6.5 Flow Channels in manhole base shall be formed of Class B concrete and mortar, while the manholes are under construction. Cut off pipes at inside face of the manhole and construct the invert to the shape and sizes of pipe indicated. All inverts shall follow the grades of the pipe entering the manholes. Changes in direction of the sewer and entering branch or branches shall be laid out in smooth curves of the longest possible radius which is tangent to the centerline of adjoining pipelines.

- 6.6 Drop Connections - Where shown on the drawings, drop connection to the manholes shall be constructed as shown on the drawings and specified herein.

- 6.7 Stub-outs - Where shown on drawings, stub-outs shall be provided for the connection of future sewer lines to manholes. The end of each stub-out shall be provided with a bell end which shall be closed by an approved stopper as specified above. Each stub-out shall be accurately referenced to the center of the manhole, and the actual invert elevation of each end of the stub-out shall be accurately recorded on the as-built drawings.

- 6.8 Special Manholes - Where shown on the drawings, special manholes shall be constructed as shown on the drawings and to the satisfaction of the Engineer.

7.0 CONCRETE ENCASEMENT, CRADLES AND SPECIALS

Provide concrete encasement, cradles and specials for pipe as shown on the drawings or directed by the Engineer in writing. Various pipe supports shall be worked out in the field and approved by the Engineer to suit local conditions and emergencies. Concrete shall conform to the specifications for Class C concrete as set out in Division 3 and shall be mixed sufficiently wet to permit it to flow under the pipe to form a continuous solid bed. In tamping concrete care shall be taken not to disturb the grade or line of the

pipe or cause injury to the joints. Concrete placed outside the specified limits or without written authorization from the Engineer will not be subject to payment.

8.0 SPECIAL STRUCTURES

Special structures shall be constructed in accordance with details and dimensions shown on the drawings or as approved by the Engineer.

9.0 TESTS

9.1 Samples for Testing - If required by the Engineer, the Contractor shall furnish after delivery on the ground as much as 10 feet of pipe for each 500' of line for testing purposes. If the Engineer desires to test a greater number of joints of pipe, the Contractor shall furnish same but shall receive compensation for the pipe at the cost of same plus his handling charges. If the Contractor desires additional tests, the Engineer shall make them but the cost of the pipe for such test will be borne by the Contractor.

9.2 Testing Gravity Sewer Mains - After the sewer system has been brought to completion and prior to final inspection, the Contractor shall rod out the entire system by pushing through each individual line in the system from manhole to manhole appropriate tools for the removal from the lines of any and all debris and obstructions. During the process of rodding the system, water shall be turned into the system in sufficient quantities to carry off the debris and trash.

After debris and trash have been removed, the Engineer will require that the Contractor pass through the complete system, under its own momentum, a ball of diameter 1" less than the nominal diameter of the sewer. Contractor shall remove and replace at his own expense any and all sections of the line that are found to be deformed to such an extent that the ball cannot freely pass. Any other obstruction, improper grade, or improper installation discovered by testing shall be corrected to the Engineer's satisfaction.

Other tests that may be conducted, if the Engineer feels necessary, are as follows:

1. Line Leakage Test - The Contractor shall be required to test all of the completed sewer lines for leakage by performing either a low-pressure air test or an infiltration/exfiltration test as described herein. The Engineer shall approve the type of test to be performed for each section of line.
2. Infiltration/Exfiltration - The Contractor will be required to so lay these sewer lines that the infiltration and/or exfiltration test does not exceed 200 gallons per inch of pipe diameter per mile per day for all sections of the sewer system for pipe less than 15 inches in diameter. In order to test such infiltration, the Engineer may require that the Contractor plug the open ends of all lines at the manhole so that measurements may be made on each section of the sewer line. This infiltration test will not be made until the sewer line is completed and the Contractor may be required to replace such sections of the line which show excessive infiltration. If weather conditions are unsatisfactory for an infiltration test at the time of completion, the Engineer may require an exfiltration test which shall be made in the following manner. The sections of sewer line to be tested shall be satisfactorily plugged at the manholes and water run in the sewer until it backs up in the upper manhole to a depth of not less than 2' above the top of the sewer pipe. The rate of loss shall be determined over a measured interval of time.
3. Low Pressure Air Test - The Contractor will furnish all equipment and facilities and all personnel for conducting the test. The test shall be observed by a representative of the Owner and/or a representative of the Engineer. The air test will be made after all services have been installed and backfilling has been completed and compacted. The first series of air tests is to be made after 2,000 linear feet of sewer has been laid but before 4,000 linear feet is completed. The purpose of this first series of tests is to assure both the Contractor and the Owner that the material and method of installation meet the intent of these specifications. The remainder of the tests are to be conducted after approximately each additional 10,000 linear feet has been laid.

All pipe ends and ends of sewer services shall be plugged with flexible joint plugs or caps securely fastened to withstand the internal test pressures. Such plug or cap shall be readily removable,

and their removal shall provide a socket suitable for making a flexible jointed lateral connection or extension.

Prior to testing, the pipe will be checked to see that it is clean. If not, it shall be cleaned by passing through the pipe a full gauge squeegee. It shall be the contractor's responsibility to have the pipe clean prior to testing.

Immediately following this check or cleaning, the pipe installation shall be tested with low-pressure air. Air shall be slowly supplied to the plugged pipe installation until the internal air pressure reaches 4.0 pounds per square inch greater than the average back pressure of any ground water that may submerge the pipe. At least two minutes shall be allowed for temperature stabilization.

The requirements of this specification shall be considered satisfied if the time required in seconds for the pressure to decrease from 3.5 to 2.5 pounds per square inch greater than the average back pressure of any ground water that may submerge the pipe is not less than that shown in the "Allowable Time Tables" listed below. Interpolate time for intermediate lengths.

Table 1

Minimum Holding Time in Seconds for Pressure to Drop from 3½ to 2½ psig
(One Pipe Size Only)

| Length (feet) | Line Size (inches) | | | | | |
|------------------|--------------------|-----|-----|-----|-----|-----|
| | 4 | 6 | 8 | 10 | 12 | 15 |
| 25 | 4 | 10 | 18 | 28 | 40 | 62 |
| 50 | 9 | 20 | 35 | 55 | 79 | 124 |
| 100 | 18 | 40 | 70 | 110 | 158 | 248 |
| 200 | 35 | 79 | 141 | 220 | 317 | 425 |
| 300 | 53 | 119 | 221 | 283 | 340 | 425 |
| 400 | 70 | 158 | 227 | 283 | 340 | 425 |
| 500 | 88 | 170 | 227 | 283 | 340 | 425 |

Table 2

Minimum Holding Time in Seconds for Pressure to Drop from 3½ to 2½ psig
(8" Main with 6" Laterals)

| Length of 6" Lateral (feet) | Length of 8" Diameter Sewer Main (feet) | | | | | | |
|--------------------------------|---|-----|-----|-----|-----|-----|-----|
| | 25 | 50 | 100 | 200 | 300 | 400 | 500 |
| 25 | 28 | 45 | 80 | 151 | 221 | 224 | 225 |
| 50 | 37 | 55 | 90 | 161 | 220 | 222 | 223 |
| 100 | 57 | 75 | 110 | 181 | 215 | 218 | 220 |
| 200 | 97 | 114 | 150 | 202 | 207 | 211 | 214 |
| 300 | 136 | 154 | 187 | 196 | 202 | 207 | 209 |
| 400 | 173 | 178 | 184 | 192 | 198 | 203 | 206 |
| 500 | 173 | 177 | 182 | 189 | 194 | 200 | 203 |

If the pipe installation fails to meet these requirements, the Contractor shall determine at his own expense the source or sources of leakage; and he shall repair or replace all defective materials or workmanship. The completed pipe installation shall meet the requirements of both the deformation and leakage tests before being considered acceptable.

Recommended Procedures For Conducting Low Pressure Air Test

- a) Clean pipe to be tested.
- b) Plug all pipe outlets with suitable test plugs. Brace each plug securely.
- c) Increase gauge pressure in the test by the amount of ground water pressure at the crown of the pipe.

- d) Add air slowly to the portion of the pipe installation under test until the internal air pressure is raised to 4.0 pounds per square inch greater than the average back pressure above the crown of the pipe.
- e) After the above internal pressure is obtained, allow at least two minutes for air temperature to stabilize adding only the amount of air required to maintain pressure.
- f) After the two-minute period, disconnect air supply.
- g) When pressure decreases to 3.5 psig, start stopwatch. Determine the time in seconds that is required for the internal air pressure to reach 2.5 psig. This time interval should then be compared with the time shown in Tables 1, 2 or 3 attached, as applicable. If the time is greater than that shown in the table, the test will be assumed to be acceptable.

Low Pressure Air Test Safety Provisions - Plugs used to close the sewer pipe for the air test must be securely braced to prevent their unintentional release. A blown plug can become a high velocity projectile which can harm or kill persons in the vicinity. The Contractor is responsible for the safety of the testing procedures, and for any accidents resulting therefrom.

Gages, air piping manifolds, and valves shall be located at the top of the ground. No one shall be permitted to enter a manhole where a plugged pipe is under pressure. Four pounds (gauge) air pressure develops a force against the plug in a 12-inch diameter pipe of approximately 450 pounds. A safety release device set to release at 10 pounds per square inch is to be provided between the air supply and the sewer under test.

- 9.3 Selection of Testing Method - The Engineer must approve use of the testing method proposed by the Contractor on a segment by segment and day by day basis.

10.0 CLEAN-UP AND SURFACE RESTORATION

10.1 Pavement Replacement

In roadway or driveway areas as soon as the pipe has been installed, the trench shall be backfilled as specified and the surface replaced as indicated below:

1. Asphalt Highway or Roadways: This item of pavement restoration shall conform to the details included in the Contract Drawings. The leveling course, binder course and the surface course shall be furnished and placed in accordance with Kentucky Department of Transportation Standard Specifications.
2. Asphalt Driveway and Parking Lot Replacement: Asphalt Driveways and Parking Lots shall be replaced equal to that existing prior to construction and shall consist of no less than 2 inches of surface course conforming to the Kentucky Department of Transportation Standard Specifications.
3. Crushed Stone Roadway Replacement or Driveway Replacement: Crushed Stone Roadways and Pavement shall be replaced to that existing prior to construction but in no case less than 6 inches in depth.

10.2 Final Grading and Seeding

Final Grading and Seeding shall be in compliance and equal to the Erosion Control requirements set forth in the Kentucky Transportation Cabinet's (KYTC) Standard Specifications, Section 212.

The Contractor shall perform permanent seeding and final grading for areas where grass growth was damaged or destroyed by the Contractor's operation, and this work shall only be done during the period of September 1 thru April 30, unless specifically waived by the Owner. Between installation and final grading, the affected area must be stabilized by other practical methods to prevent erosion and protect the exposed areas. In areas of established lawns no rock shall be left in the top 6" of soil and the finished grade shall be equivalent to that which existed before construction began. In all cases, lawn and pasture

areas shall be left neat and in a condition so that mowing is as easy and convenient as before construction began. The lawn areas and other areas disturbed by the Contractor's activities shall have ground cover restored to a condition satisfying the affected landowner and Owner.

Final Grading and Seeding requirements are as indicated below:

1. Placement of Topsoil: Where warranted and requested, topsoil shall be spread after grading and shaping of the area to receive the material is completed and seeding and protection operations are ready to begin. Spread and lightly compact the topsoil to uniform depth of approximately 6 inches over areas specified by the Owner or Engineer. Topsoil should not be placed on slopes steeper than 3:1.
2. Seed Mixture for Permanent Seeding: For permanent seeding on slopes 3:1 or less, a Type 1 seed mix shall be applied at a minimum rate of 100 pounds per acre. For steeper slopes, apply a Type 3 mix as specified in the KYTC Standard Specification 212.03.03.
Seed Mix Type 1:
 - 30% Kentucky 31 Tall Fescue
 - 20% Creeping Red Fescue
 - 35% Hard Fescue
 - 10% Ryegrass, Annual
 - 5% White Dutch Clover
3. Procedure for Permanent Seeding: Prepare a seedbed and incorporate a minimum of 100 pounds of nitrogen, 100 pounds of phosphate, 100 pounds of potash, and 3 tons of agricultural limestone per acre. Add additional fertilizer and agricultural limestone as needed. Do not apply dry agricultural Limestone when it may generate a traffic hazard. Remove all rock in the top 6" of the soil, and all dirt clods over 4 inches in diameter shall be removed from the surface of the seedbed. All seeding shall be mechanically tracked into the seedbed, utilizing a power seeder, Harley rake, cultipacker, or other approved device. For all slopes 3:1 or greater, ensure that tracking is performed up and down and not across. Seed and mulch to produce a uniform vegetation cover using the seeding rates as indicated to each application. Mulch with clean, weed free straw. Place straw to an approximate 2-inch loose depth (2 tons per acre) and anchor it into the soil by mechanically crimping it into the soil surface or applying tackifier to provide a protective cover. For the periods of March 1 through May 15 and from September 1 through November 1, the Owner will allow the option of using hydromulch at minimum rate of 1,500 pounds per acre in place of straw with tackifier. Regardless of materials used, ensure the protective cover holds until seeding is acceptably established.
4. Maintenance of Seeded Areas during Warranty Period: From the time seeding and protection work begins until the date the project is declared complete (i.e. Warranty Expiration), keep all seeded areas in good condition at all times. Promptly repair any damage to seeded areas or to mulch materials as directed.

END OF SECTION 02-190

MEASUREMENT AND PAYMENT

1.0 GENERAL

The Contractor shall furnish all labor, tools, equipment and materials to construct the proposed improvements complete as shown on the plans and described in these Specifications. The work shall be measured for payment in accordance with applicable provisions of these Specifications and payment shall be made on the basis of the unit prices or lump sum prices bid. The sum of the payments for eligible pay items contained in the proposal form shall be the compensation to be paid for the completed project; provided however, that changes in the work covered by written change orders, properly executed, may result in additions or deductions from the contract price.

The Contractor's attention is called to the fact that although the pay items shown shall be the basis for establishing the contract price, the description of the pay items do not necessarily reflect the full extent of work to be performed. The cost of the incidental work such as clearing and grubbing, trenching, backfilling, testing, etc., which is necessary but which is not specifically listed as one of the pay items, shall be included in the prices bid for the pay items to which the incidental work is most closely related.

2.0 GRAVITY SEWER MAINS

- A. Measurement - Sewer mains shall be measured for payment by horizontal measurements or station distances (to the nearest 1-foot) along the centerline of the pipe within its respective depth range, as listed on the Bid Form. Sewer main size shall be based on nominal pipe diameter as shown on the Plans.
- B. Payment - Sewer mains shall be paid for on the basis of the respective unit prices bid per linear foot for pipe in all depth ranges. Partial payments for sewer line installations shall be based upon the following percentages:

| <u>Status</u> | <u>Maximum Percentage of Bid Price</u> |
|---|--|
| Line installed and backfilled only | 70% |
| Line installed, backfilled, debris/rock removed, & rough clean-up completed | 80% |
| Line installed, backfilled, debris removed, rough clean-up, & successfully tested | 90% |
| Line installed, backfilled, successfully tested & final surface restoration completed | 100% |

The foregoing partial payments will be subject to retainage.

Payment for furnishing and installing the sewer mains shall constitute compensation in full for furnishing all labor, tools, equipment and materials and installing the sewer mains complete, including incidental work such as location and protection of existing utilities, clearing, excavation (including rock), dewatering trenches, bedding with crushed stone in accordance with Specifications, fittings, thrust blocks, driveway and private road crossings and bores (including surface and pavement restoration), detector tape (where required) backfilling, disposal of surplus excavated material, the removal of existing timber, structures and piping to be relocated or abandoned; also sheeting, diking, well pointing, bailing, dewatering; the furnishing, placing and removal of bulkheads, and restoration of any utilities, parkways, trees, turf, shrubbery, culverts, fences, and other surface features, and testing.

Backfill shall be in accordance with Specification 02-190, and the cost thereof shall be included in the appropriate bid price. Where the sewer line is to be installed under roadways, railroads, creeks, or other special crossings for which a specific pay item is provided, payment based on the measured quantity and unit cost of the work shall be made in addition to the base unit cost for the designation of pipe provided as compensation for the additional work associated with the installation.

Final Surface Restoration shall be in accordance with Specification 02-190, Section 10.2

3.0 FINAL CLEANUP OF GRAVITY SEWER MAINS (All sizes)

- A. Measurement – Final Cleanup of Gravity Sewer Mains shall be measured for payment by horizontal measurements or station distances along the centerline of the pipe to the nearest 1 foot actually installed in accordance with the contract drawings and specifications.
- B. Payment – Final Cleanup of Gravity Sewer Mains shall be paid for on the basis of the respective unit price bid per linear foot, for all pipe size, in accordance with the contract drawings and specifications. **Note: All Bidders shall include the specified unit price (See the Bid Form) as a minimum, for Final Cleanup.**

Payment for final cleanup of installed Gravity Sewer Mains and Sewer Force Mains shall constitute compensation in full for furnishing all labor, tools, equipment and materials for complete land restoration from the sewer main installation. Specific work items for the following areas shall be included for the payment:

- i. Residential Yards: The Gravity Sewer Mains and Sewer Force Mains areas shall be free of all rocks, and the area shall be fine graded and thickly sown in accordance with Specification 02-190, Section 10.2 or Specification 02-195, Section 8.2. If warranted, new top soil shall be placed to cover poor, rocky soil and promote the healthy re-growth of grass in the affected portions of the yard. Additionally, if the Contractor hauls off and disposes a load of waste material (i.e. rock) from a particular yard, the Owner reserves the right to request the Contractor haul in and replace the area with an equal amount of suitable, topsoil material at no additional cost. Prior to final seeding, all areas shall be leveled and trench settlement shall be sufficiently backfilled to bring the areas back to their original grade. Final Seeding and Grading to affected areas shall only be completed between September 1 and April 30. Upon completion of the final cleanup, the Contractor shall obtain and supply the Owner with a handwritten acceptance notice from each affected landowner (Sample included in the Appendix). A landowner's acceptance does not supersede the Owner's acceptance, and the Owner reserves the right to request that leftover debris be thoroughly removed from the utility easement or hauled to the landowner's desired location on the respective parcel.
- ii. Row-Crop Fields: The Gravity Sewer Mains and Sewer Force Mains areas shall be free of all rocks. All areas shall be leveled and trench settlement shall be sufficiently backfilled to bring the areas back to their original grade. Additionally, if the Contractor hauls off and disposes a load of waste material (i.e. rock) from a particular location, the Owner reserves the right to request the Contractor haul in and replace the area with an equal amount of suitable, topsoil material at no additional cost. Upon completion of the final cleanup, the Contractor shall provide evidence of crop damage restitution with each affected landowner, and the Contractor shall obtain and supply the Owner with a signed acceptance notice from each affected landowner (Sample included in the Appendix).
- iii. Pasture Fields: The Gravity Sewer Mains and Sewer Force Mains areas shall be free of all rocks, and the area shall be graded and seeded sown in accordance with Specification 02-190, Section 10.2 or Specification 02-195, Section 8.2. Additionally, if the Contractor hauls off and disposes a load of waste material (i.e. rock) from a particular field, the Owner reserves the right to request the Contractor haul in and replace the area with an equal amount of suitable, topsoil material at no additional cost. Prior to final seeding, all areas shall be leveled and trench settlement shall be sufficiently backfilled to bring the areas back to their original grade. Final Seeding and Grading to affected areas shall only be completed between September 1 and April 30. Upon completion of the final cleanup, the Contractor shall obtain and supply the Owner with a handwritten acceptance notice from each affected landowner (Sample included in the Appendix). A landowner's acceptance does not supersede the Owner's acceptance, and the Owner reserves the right to request that leftover debris be thoroughly removed from the utility easement or hauled to the landowner's desired location on the respective parcel.

4.0 SEWER SERVICE LINE (If applicable)

- A. Measurement - Service line shall be measured by linear footage of service line actually installed (regardless of depth) in accordance with the contract drawings and specifications in the

completed system. Service line installation is to include any required excavation, pipe bedding and backfill and surface restoration.

- B. Payment - Sewer services shall be paid for on the basis of the respective unit prices bid per linear foot to the nearest one foot. Partial payments for sewer line installations shall be based upon the following percentages:

| <u>Status</u> | <u>Maximum Percentage of Bid Price</u> |
|---|--|
| Line installed and backfilled only | 70% |
| Line installed, backfilled, debris/rock removed, & rough clean-up completed | 80% |
| Line installed, backfilled, debris removed, rough clean-up, & successfully tested | 90% |
| Line installed, backfilled, successfully tested & final surface restoration completed | 100% |

The foregoing partial payments will be subject to retainage.

Payment for furnishing and installing the sewer services shall constitute compensation in full for furnishing all labor, tools, equipment and materials and installing the sewer services complete, including incidental work such as location and protection of existing utilities, clearing, excavation (including rock), dewatering trenches, bedding with crushed stone in accordance with Specifications, backfilling, disposal of surplus excavated material, the removal of existing timber, structures and piping to be relocated or abandoned, and restoration of any utilities, culverts, fences, and other surface features, and acceptance testing. Rough clean-up shall be defined as having installed and backfilled the line, removed any excess materials and debris, and having the surface prepared to receive finished surface restoration.

Final Surface Restoration shall be in accordance with Specification 02-190, Section 10.2

5.0 MANHOLES

- A. Measurement - Manholes shall be measured by count and depth of each unit actually installed within its respective depth range, as listed on the Bid Form, all in accordance with the contract drawings and specifications in the completed system.
- B. Payment - Payment shall be at the unit bid price for the measured quantity. Payment shall include the manhole along with all related supplies and materials required for a complete installation in accordance with the contract drawings and specifications.

6.0 STEEL CASSED GRAVITY SEWER ROAD BORE

- A. Measurement - Steel cased gravity sewer road bore shall be measured to the nearest 1 linear foot of bore as shown on the Contact Drawings for each size of casing and carrier pipe installed in accordance with the contract drawings and specifications.
- B. Payment - Payment shall be at the unit bid price for the measured quantity. Payment shall include the steel casing pipe, installation of the casing and the carrier pipes, all required materials, supplies and equipment for a complete installation.

7.0 STEEL CASSED GRAVITY SEWER RAILROAD BORE

- A. Measurement - Steel cased gravity sewer railroad bore shall be measured to the nearest 1 linear foot of bore as shown on the Contact Drawings for each size of casing and carrier pipe installed in accordance with the contract drawings, project specifications and AREMA specifications (American Railway Engineering and Maintenance-of-Way Association).
- B. Payment - Payment shall be at the unit bid price for the measured quantity. Payment shall include the steel casing pipe (excluding the carrier pipe), excavation, installation and backfill of the pipes, all required materials, supplies and equipment for a complete installation as well as all associated pavement and/or surface repair required for a complete installation. For the CSX crossing, the application and permit fees have been paid by the Owner. The Contractor will be required to coordinate payment with the Owner and/or CSX for all applicable flagging and inspection fees, billed during construction. For CSX questions, contact Eric Horton at (904) 279-3806.

8.0 UNCASED DRIVEWAY BORE (If applicable)

- A. Measurement – Uncased driveway bores shall be measured to the nearest 1 linear foot of bore as shown on the Contact Drawings for each size of carrier pipe installed in accordance with the contract drawings and specifications.
- B. Payment - Payment shall be at the unit bid price for the measured quantity. Payment shall include the installation of the carrier pipe, all required materials, supplies and equipment for a complete installation.

9.0 SEWER SERVICE LINE ROAD BORE (If applicable)

- A. Measurement - Steel cased service line road bore shall be measured to the nearest 1 linear foot of bore as shown on the Contact Drawings for each size of casing and carrier pipe installed in accordance with the contract drawings and specifications.
- B. Payment - Payment shall be at the unit bid price for the measured quantity. Payment shall include the steel casing pipe, boring, installation of the casing and the carrier pipes, all required materials, supplies and equipment for a complete installation.

10.0 WIDE STREAM CROSSING (All Line Sizes)

- A. Measurement – Wide Stream crossings shall be measured to the nearest 1-foot of crossing actually installed in accordance with the contract drawings and specifications in the completed system.
- B. Payment - Payment shall be at the unit bid price for the measured quantity. Payment shall include fittings for deflection, steel casing pipe if applicable per bury depth (excluding DIP carrier pipe), waterline markers, any temporary measures taken to control water flow in the river, excavation, installation of the water main and casing, backfilling, concrete encasement where required, rip rap channel & bank lining, removal of temporary water control measures, accessories and related work referenced by the plans and specifications or otherwise required for a complete and working installation. Payment shall also include any erosion control measures justified by the construction as well as any measures needed to return sediment-free water back into the stream. Payment shall also include adhering to any special provisions specifically instructed by the Army Corp of Engineer &/or the KDOW Stream Construction Permits, obtained by the Owner.

11.0 WETLAND CROSSING & RESTORATION

- A. Measurement – Wetland Crossings & Restoration shall be measured to the nearest 1-foot of crossing actually installed in accordance with the contract drawings and specifications in the completed system.
- B. Payment - Payment shall be at the unit bid price for the measured quantity. Payment shall include trench plugs, protection/preservation of vegetation, erosion control measures justified by the construction as well as any measures needed to preclude sediment entering wetland areas, stripping/salvaging and backfilling native topsoil in each area, and replanting/reseeding the areas with indigenous wetland plants or native seedlings. Payment shall also include all accessories and related work referenced by the plans and specifications or otherwise required for a complete and working installation. Payment shall also include adhering to any special provisions specifically instructed by the Army Corp of Engineer &/or the KDOW Stream Construction Permits, obtained by the Owner.

12.0 CREEK/SHALLOW DITCH CROSSING (All line Sizes)

- A. Measurement - Creek or Shallow Ditch crossings shall be measured to the nearest 1-foot of crossing actually installed in accordance with the contract drawings and specifications in the completed system.

- B. Payment - Payment shall be at the unit bid price for the measured quantity. Payment shall include casing pipe where required by rock depth, any temporary measures taken to control water flow in the creek, excavation, installation of the water main and/or casing (as required), backfilling, concrete encasement where required, rip rap channel and bank lining, removal of temporary water control measures, accessories and related work referenced by the plans and specifications or otherwise required for a complete and working installation. Payment shall also include any erosion control measures justified by the construction as well as any measures needed to return sediment-free water back into the river. Payment shall also include adhering to any special provisions specifically instructed by the Army Corp of Engineer &/or the KDOW Stream Construction Permits, obtained by the Owner.

13.0 SEWER LINE MARKERS (if applicable)

- A. Measurement – Isolated pipeline markers, where ordered by the Engineer, shall be measured as the actual number installed.
- B. Payment – Payment will be made at the unit bid price for the measured quantity.

14.0 UNDERCUT AND REFILL (if applicable)

- A. Measurement - Where directed by the Engineer to undercut an excavation to avoid unstable soils, the undercut shall be measured as the actual volume of material removed from the excavation in excess of that which would have been otherwise required. Refill shall be measured as the actual volume of crushed stone or concrete refill placed in accordance with the Engineer's directions. Undercut or refill made without the direction or concurrence of the Engineer will not be measured for payment. Unclassified aggregate refill is not applicable for gravel driveway backfilling. No differentiation will be made between rock and soil undercutting.
- B. Payment - Payment shall be at the unit bid price for the measured quantity. Payment shall include removing and disposing of undercut materials, placing and compacting any refill materials, and all other work as required for a complete and working installation.

15.0 SEWER SERVICE TAPS (if applicable)

- A. Measurement - Service connections shall be measured by count of each by lateral size actually installed in accordance with the contract drawings and specifications in the completed system.
- B. Payment - Payment shall be at the unit bid price for the measured quantity. Payment shall include the tee, riser, fittings and plug (where required) along with all related supplies and materials required for a complete installation in accordance with the contract drawings and specifications.

16.0 SEWER SERVICE CLEAN OUTS (if applicable)

- A. Measurement - Cleanouts shall be measured by count of each installed in accordance with the contract drawings and specifications in the completed system.
- B. Payment - Payment shall be at the unit bid price for the measured quantity. Payment shall include the tee, riser, fittings and plug along with all related supplies and materials required for a complete installation in accordance with the contract drawings and specifications.

17.0 OPEN CUT CASED ROAD CROSSING (if applicable)

- A. Measurement - Open cut cased road crossing shall be measured to the nearest 1 linear foot of crossing as shown on the Contact Drawings for each size casing and carrier pipe installed in accordance with the contract drawings and specifications.
- B. Payment - Payment shall be at the unit bid price for the measured quantity. Payment shall include the steel casing pipe (excluding the PVC carrier pipe), excavation, installation and backfill of the casing and sewer main, all required materials, supplies and equipment for a complete installation as well as all associated pavement and/or surface repair required for a complete installation.

Payment shall also include adhering to any special provisions instructed by County/State Highway Officials and the encroachment permit(s) obtained by the Owner.

18.0 ASPHALT REPLACEMENT (if applicable)

- A. Measurement - The replacement of asphalt surface (non-roadway crossing areas) shall be measured for payment by horizontal measurements or station distances along the centerline of the pipe to the nearest 1 foot (all depths).
- B. Payment - Payment shall be at the unit bid price for the measured quantity. Payment shall be total compensation for saw cutting, granular backfill or flowable concrete fill (as specified), furnishing and placing all base and surfacing materials, including rolling and finishing, for disposal of all surplus material, and for all labor, tools, equipment and incidentals necessary to complete the work, all in accordance with the plans and specifications.

19.0 CONCRETE REPLACEMENT (if applicable)

- A. Measurement - The replacement of concrete surface (non-roadway crossing areas) shall be measured for payment by horizontal measurements or station distances along the centerline of the pipe to the nearest 1 foot (all depths).
- B. Payment - Payment shall be at the unit bid price for the measured quantity. Payment shall be total compensation for saw cutting, granular backfill or flowable concrete fill (as specified), furnishing and placing all base and surfacing materials, including reinforcement and finishing, for disposal of all surplus material, and for all labor, tools, equipment and incidentals necessary to complete the work, all in accordance with the plans and specifications.

20.0 CONNECTION TO EXISTING MANHOLE OR WET WELL

- A. Measurement – Connections to existing manhole or wet well shall be measured by count of connections actually installed in accordance with the contract drawings and specifications in the completed system.
- B. Payment - Payment shall be at the unit bid price for the measured quantity. Payment shall include locating and excavating around the existing structure, coring a hole at the proper diameter and elevation in the structure, and furnishing all materials and accessories necessary to make the pipe connection to the structure, all in accordance with the plans specifications.

END OF SECTION 02-950

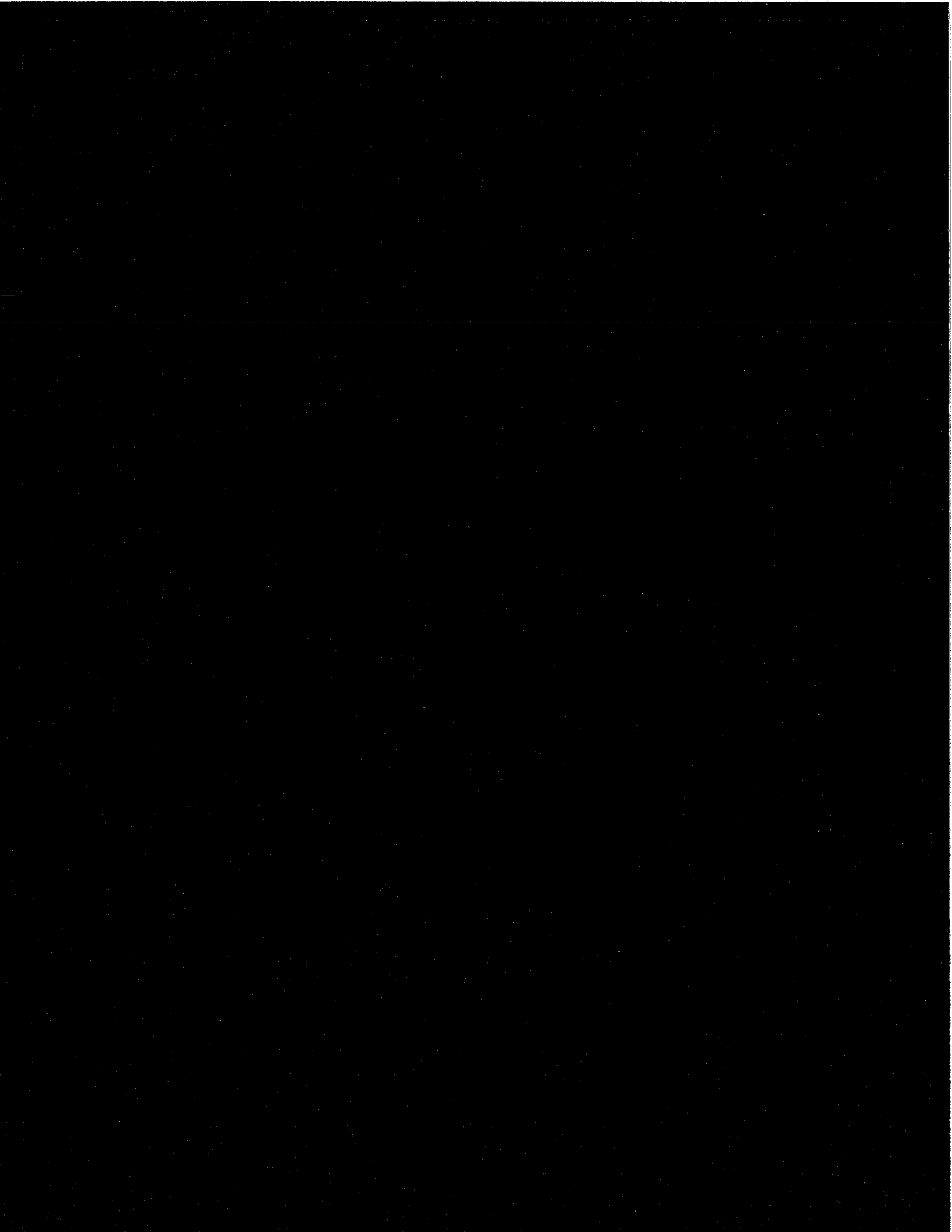

APPENDIX 1

KPDES FORM NOI-SW

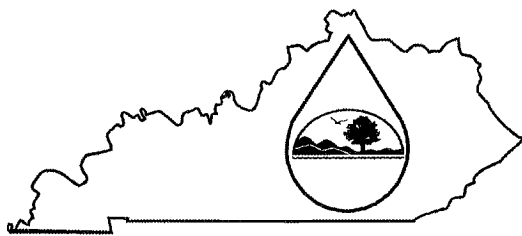

Kentucky Pollutant Discharge Elimination System
(KPDES)
Notice of Intent (NOI)
for Storm Water Discharges
Associated with Industrial Activity Under the
KPDES General Permit

Submission of this Notice of Intent constitutes notice that the party identified in Section I of this form intends to be authorized by a KPDES permit issued for storm water discharges associated with industrial activity. Becoming a permittee obligates such discharger to comply with the terms and conditions of the permit.

ALL NECESSARY INFORMATION MUST BE PROVIDED ON THIS FORM (See Instructions on back)

I. Facility Operator Information

| | | | |
|------------------------|--|---------------------------|--|
| Name: | | Phone: | |
| Address: | | Status of Owner/Operator: | |
| City, State, Zip Code: | | | |

II. Facility/Site Location Information

| | | | |
|---|--|--|--|
| Name: | | | |
| Address: | | | |
| City, State, Zip Code: | | | |
| County: | | | |
| Site Latitude: (degrees/minutes/seconds) | | Site Longitude: (degrees/minutes/seconds) | |

III. Site Activity Information

| | | | | |
|--|------------------------------|--------------------------------|-----|-----|
| MS4 Operator Name: | | | | |
| Receiving Water Body: | | | | |
| Are there existing quantitative data? | Yes <input type="checkbox"/> | If Yes, submit with this form. | | |
| | No <input type="checkbox"/> | | | |
| SIC or Designated Activity Code Primary | | 2nd | 3rd | 4th |
| If this facility is a member of a Group Application, enter Group Application Number: | | | | |
| If you have other existing KPDES Permits, enter Permit Numbers: | | | | |

IV. Additional Information Required FOR CONSTRUCTION ACTIVITIES ONLY

| | | | |
|--|------------------------------|-----------------------------|--|
| Project Start Date: | | Completion Date: | |
| Estimated Area to be disturbed (in acres): | | | |
| Is the Storm Water Pollution Prevention Plan in Compliance with State and/or Local Sediment and Erosion Plans? | Yes <input type="checkbox"/> | No <input type="checkbox"/> | |

V. Certification: I certify under penalty of law that this document and all attachments were prepared under my direction or supervision in accordance with a system designed to assure that qualified personnel properly gather and evaluate the information submitted. Based on my inquiry of the person or persons who manage the system, or those persons directly responsible for gathering the information, the information submitted is, to the best of my knowledge and belief, true, accurate, and complete. I am aware that there are significant penalties for submitting false information, including the possibility of fine and imprisonment for knowing violations.

| | | | |
|------------------------|--|-------|--|
| Printed or Typed Name: | | | |
| Signature: | | Date: | |

Kentucky Pollutant Discharge Elimination System (KPDES)
Instructions
Notice of Intent (NOI) for Storm Water Discharges Associated with Industrial Activity
To Be Covered Under The KPDES General Permit

WHO MUST FILE A NOTICE OF INTENT (NOI) FORM

Federal law at 40 CFR Part 122 prohibits point source discharges of stormwater associated with industrial activity to a water body of the Commonwealth of Kentucky without a Kentucky Pollutant Discharge Elimination System (KPDES) permit. The operator of an industrial activity that has such a storm water discharge must submit a NOI to obtain coverage under the KPDES Storm Water General Permit. If you have questions about whether you need a permit under the KPDES Storm Water program, or if you need information as to whether a particular program is administered by the state agency, call the Storm Water Contact, Industrial Section, Kentucky Division of Water at (502) 564-3410.

WHERE TO FILE NOI FORM

NOIs must be sent to the following address:

Section Supervisor
Inventory & Data Management Section
KPDES Branch, Division of Water
Frankfort Office Park
14 Reilly Road
Frankfort, KY 40601

COMPLETING THE FORM

Type or print legibly in the appropriate areas only. If you have any questions regarding the completion of this form call the Storm Water Contact, Industrial Section, at (502) 564-3410.

SECTION I - FACILITY OPERATOR INFORMATION

Give the legal name of the person, firm, public organization, or any other entity that operates the facility or site described in this application. The name of the operator may or may not be the same as the name of the facility. The responsible party is the legal entity that controls the facility's operation, rather than the plant or site manager. Do not use a colloquial name. Enter the complete address and telephone number of the operator.

Enter the appropriate letter to indicate the legal status of the operator of the facility.

F = Federal M = Public (other than federal or state)
S = State P = Private

SECTION II - FACILITY/SITE LOCATION INFORMATION

Enter the facility's or site's official or legal name and complete street address, including city, state, and ZIP code.

SECTION III - SITE ACTIVITY INFORMATION

If the storm water discharges to a municipal separate storm sewer system (MS4), enter the name of the operator of the MS4 (e.g., municipality name, county name) and the receiving water of the discharge from the MS4. (A MS4 is defined as a conveyance or system of conveyances (including roads with drainage systems, municipal streets, catch basins, curbs, gutters, ditches, man-made channels, or storm drains) that is owned or operated by a state, city, town, borough, county, parish, district, association, or other public body which is designed or used for collecting or conveying storm water.)

If the facility discharges storm water directly to receiving water(s), enter the name of the receiving water.

Indicate whether or not the owner or operator of the facility has existing quantitative data that represent the characteristics and concentration of pollutants in storm water discharges. If data is available submit with this form.

List, in descending order of significance, up to four 4-digit standard industrial classification (SIC) codes that best describe the principal products or services provided at the facility or site identified in Section II of this application.

If the facility listed in Section II has participated in Part 1 of an approved storm water group application and a group number has been assigned, enter the group application number in the space provided.

If there are other KPDES permits presently issued for the facility or site listed in Section II, list the permit numbers.

SECTION IV - ADDITIONAL INFORMATION REQUIRED FOR CONSTRUCTION ACTIVITIES ONLY

Construction activities must complete Section IV in addition of Sections I through III. Only construction activities need to complete Section IV.

Enter the project start date and the estimated completion date for the entire development plan.

Provide an estimate of the total number of acres of the site on which soil will be disturbed (round to the nearest acre).

Indicate whether the storm water pollution prevention plan for the site is in compliance with approved state and/or local sediment and erosion plans, permits, or storm water management plans.

SECTION V - CERTIFICATION

Federal statutes provide for severe penalties for submitting false information on this application form. Federal regulations require this application to be signed as follows:

For a corporation: by a responsible corporate officer, which means: (i) president, secretary, treasurer, or vice-president of the corporation in charge of a principal business function, or any other person who performs similar policy or decision making functions, or (ii) the manager of one or more manufacturing, production, or operating facilities employing more than 250 persons or having gross annual sales or expenditures exceeding \$25 million (in second-quarter 1980 dollars), if authority to sign documents has been assigned or delegated to the manager in accordance with corporate procedures;

For a partnership or sole proprietorship: by a general partner or the proprietor; or

For a municipality, state, Federal, or other public facility: by either a principal executive officer or ranking elected official.

APPENDIX 2

AMERICAN IRON AND STEEL COMPLIANCE STATEMENT

"Section 746 of Title VII of the Consolidated Appropriations Act of 2017 (Division A- Agriculture, Rural Development, Food and Drug Administration, and Related Agencies Appropriations Act, 2017) and subsequent statues mandating domestic preference applies an American Iron and Steel requirement to this project.

All parties are required to comply with these requirements and to ensure that all iron and steel products used on this project are produced in the United States. The term "iron and steel products" means the following products made of primarily iron or steel: lined or unlined pipes and fittings, manhole covers and other municipal castings, hydrants, tanks, flanges, pipe clamps and restraints, valves, structural steel, reinforced precast concrete, and construction materials."

RD Specialist Signature

Date

Printed Name

Borrower Signature or Approved Representative

Date

Printed Name

Engineer's Signature

Date

Printed Name

Contractor's Signature

Date

Printed Name

ENGINEER'S CERTIFICATION LETTER

DATE:

RE: APPLICANT
PROJECT NAME
CONTRACT NUMBER

I hereby certify that to the best of my knowledge and belief, iron and steel products referenced in the Plans, Specifications, and Bidding Documents for this project comply with Section 746 of Title VII of the Consolidated Appropriations Act of 2017 and any subsequent statutes mandating domestic preference or are the subject of a waiver approved by the Secretary of Agriculture or designee. This certification is not intended to be a warranty in any way, but rather the designer's professional opinion that to the best of their knowledge, the products comply.

I hereby commit that to the best of my ability, all iron and steel products that will be referenced in the Bid Addenda, Executed contracts, and Change Orders will comply with Section 746 of the Title VII of the Consolidated Appropriations Act, 2017 and any subsequent statutes mandating domestic preference or are/will be the subject of a waiver approved by the Secretary of Agriculture or designee.

Name of Engineering Firm (Print)

By Authorized Representative (Signature)

Title

This document is to be submitted prior to Agency authorization for Advertisement for Bids.

CONTRACTOR'S CERTIFICATION LETTER

DATE:

**RE: APPLICANT
PROJECT NAME
CONTRACT NUMBER**

I hereby certify that, to the best of my knowledge and belief, all iron and steel products installed for this project by my company and by any and all subcontractors and manufacturers my company has contracted with for this project, comply with Section 746 of Title VII of the Consolidated Appropriations Act of 2017 and any subsequent statutes mandating domestic preference or are the subject of a waiver approved by the Secretary of Agriculture or designee.

Name of Construction Company (Print)

By Authorized Representative (Signature)

Title

This certification is to be submitted upon completion of the project to the project engineer.

MANUFACTURER'S CERTIFICATION LETTER

Date:

Company Name:

Company Address:

Subject: AIS Step Certification for Project (X), Owner's Name, and Contract Number

I, (company representative), certify that the (melting, bending, galvanizing, cutting, etc.) processes for (manufacturing or fabricating) the following products and/or material shipped or provided for the subject project is in full compliance with the mandated AIS requirements.

Item, Products and/or Materials, and location of delivery (City, State)

- 1.
- 2.
- 3.

Such process for AIS took place in the following location:

City, State

This certification is to be submitted upon request to interested parties (e.g. municipalities, consulting engineers, general contractors, etc.)

If any of the above compliance statements change while providing materials to this project, please immediately notify the person(s) who is requesting to use your product(s).

Authorized Company Representative

(Note: Authorized signature shall be manufacturer's representative and not the materials distributor or supplier)

EXAMPLES OF MUNICIPAL CASTINGS *(includes but not limited to):*

Access Hatches
Ballast Screen
Benches (Iron or Steel)
Bollards
Cast Bases
Cast Iron Hinged Hatches, Square and Rectangular
Cast Iron Riser Rings
Catch Basin Inlet
Cleanout/Monument Boxes
Construction Covers and Frames
Curb Corner Guards
Curb Openings
Detectable Warning Plates
Downspout Shoes (Boot, Inlet)
Drainage Grates, Frames and Curb Inlets
Inlets
Junction Boxes
Lampposts
Manhole Covers, Rings and Frames, Risers
Meter Boxes
Service Boxes
Steel Hinged Hatches, Square and Rectangular
Steel Riser Rings
Trash Receptacles
Tree Grates
Tree Guards
Trench Grates
Valve Boxes, Covers and Risers

EXAMPLES OF CONSTRUCTION MATERIALS (included but not limited to)

Wire rod, bar, angles
Concrete reinforcing bar, wire, wire cloth
Wire rope and cables
Tubing
Framing
Joists
Trusses
Fasteners (i.e., nuts and bolts)
Welding rods
Decking
Grating
Railings
Stairs
Access ramps
Fire escapes
Ladders
Wall panels
Dome structures
Roofing
Ductwork
Surface drains
Cable hanging systems
Manhole steps
Fencing and fence tubing
Guardrails
Doors
Stationary screens

EXAMPLES OF NON-CONSTRUCTION MATERIALS- (includes but not limited to):

(Note: includes appurtenances necessary for their intended use and operation and are not subject to AIS requirements)

Pumps

Motors

Gear Reducers

Drives (including variable frequency drives (VFD's)

Electric/pneumatic/manual accessories used to operate valves (such as electric valve actuators).

Mixers

Gates (e.g. sluice and slide gates)

Motorized screens (such as traveling screens)

Blowers/aeration equipment

Compressors

Meters (flow and water meters)

Sensors

Controls and switches

Supervisory control data acquisition (SCADA)

Membrane filtration systems (includes RO package plants)

Filters

Clarifier arms and clarifier mechanisms

Rakes

Grinders

Disinfection systems

Presses (including belt presses)

Conveyors

Cranes

HVAC (excluding network)

Water heaters

Heat exchangers

Generators

Cabinetry and housing (such as electrical boxes/enclosures)

Lighting fixtures

Electrical conduit

Emergency life systems

Metal office furniture

Shelving

Laboratory equipment

Analytical instrumentation

Dewatering equipment

INFORMATIONAL CHECKLIST FOR PROJECT SPECIFIC WAIVER REQUEST
 Please reference the specifications of the product.

| Information | <input type="checkbox"/> | Note |
|--|--------------------------|------|
| <p>General</p> <ul style="list-style-type: none"> • Waiver request includes the following information: <ul style="list-style-type: none"> — Description of the foreign and domestic construction materials — Unit of measure — Quantity — Price — Date that product is needed (e.g. time of delivery or availability) — Location of the construction project — Name and address of the proposed supplier — A detailed justification for the use of foreign construction materials • Waiver request was submitted according to the instructions in the memorandum • Assistance recipient made a good faith effort to solicit bids for domestic iron and steel products, as demonstrated by language in requests for proposals, contracts, and communications with the prime | | |
| <p>Cost Waiver Requests</p> <ul style="list-style-type: none"> • Waiver request includes the following information: <ul style="list-style-type: none"> — Comparison of overall cost of project with domestic iron and steel products to overall cost of project with foreign iron and steel products (Exhibit J) — Relevant excerpts from the bid documents used by the contractors to complete the comparison — Supporting documentation indicating that the contractor made a reasonable survey of the market, such as a description of the process for identifying suppliers and a list of contacted suppliers | | |
| <p>Availability Waiver Requests</p> <ul style="list-style-type: none"> • Waiver request includes the following supporting documentation necessary to demonstrate the availability, quantity, and/or quality of the materials for which the waiver is requested: <ul style="list-style-type: none"> — Supplier information or pricing information from a reasonable number of domestic suppliers indicating availability/delivery date for construction materials — Documentation of the assistance recipient's efforts to find available domestic sources, such as a description of the process for identifying suppliers and a list of contacted suppliers. — Date that product is needed (e.g. time of delivery or availability) to provide justification — Relevant excerpts from project plans, specifications, and permits indicating the required quantity and quality of construction materials • Waiver request includes a statement from the prime contractor and/or supplier confirming the non-availability of the domestic construction materials for which the waiver is sought • Has the State received other waiver requests for the materials described in this waiver request, for comparable projects? | | |

APPENDIX 3



MATTHEW G. BEVIN
GOVERNOR

CHARLES G. SNAVELY
SECRETARY

ENERGY AND ENVIRONMENT CABINET
DEPARTMENT FOR ENVIRONMENTAL PROTECTION

ANTHONY R. HATTON
COMMISSIONER

300 SOWER BOULEVARD
FRANKFORT, KENTUCKY 40601

October 20, 2018

Scott Marshall
Guthrie Water & Sewer
110 Kendall St
Guthrie, KY 42234

Re: Novelis Sanitary Sewer Extension Project
Todd County, Kentucky
Guthrie WWTP
Activity ID #: 4018, APE20180001
Receiving Treatment Plant KPDES #: KY0063649

Dear Mayor Marshall:

We have reviewed the plans and specifications for the above referenced project. The plans include the construction of approximately 3,771 linear feet of 12 inch DI sanitary sewer. This is to advise that plans and specifications for the above referenced project are APPROVED with respect to sanitary features of design, as of this date with the requirements contained in the attached construction permit.

If we can be of any further assistance or should you wish to discuss this correspondence, please do not hesitate to contact Daniel Kulik at 502-782-6998.

Sincerely,

Terry Humphries, P.E.
Supervisor, Engineering Section
Water Infrastructure Branch
Division of Water

TH / DK
Enclosures

c: Todd County Health Department
McGhee Engineering Inc
Division of Plumbing
City of Guthrie



Sewer Line Construction
Guthrie WWTP
Facility Requirements

Activity ID No.: APE20180001

GACT0000000003 (Novelis Sanitary Sewer Extension Project) 3771 linear feet of 12 inch DI sanitary sewer:

Submittal/Action Requirements:

| Condition No. | Condition |
|---------------|--|
| S-1 | When this project is completed, the applicant shall: submit written certification: Due 30 calendar days after Completion of Construction to the Division of Water that the facilities have been constructed and tested in accordance with the approved plans and specifications and the approval conditions. Such certification shall be signed by a registered professional engineer. Failure to certify may result in penalty assessment and/or future approvals being withheld. [401 KAR 5:005 Section 24(2)] |

Narrative Requirements:

| Condition No. | Condition |
|---------------|---|
| T-1 | The plans and specifications submitted for the project are approved by the Department of Environmental Protection as to sanitary features, subject to the requirements contained within the permit. [401 KAR 5:005 Section 24(3)] |
| T-2 | Authority to construct these sewers is hereby granted. This approval is issued under the provisions of KRS Chapter 224.10-100 (19) regulations promulgated pursuant thereto. Issuance of this permit does not relieve the permittee from the responsibility of obtaining any permits or licenses required by this cabinet and other state, federal, and local agencies. [401 KAR 5:005 Section 24(3)(c)2] |
| T-3 | A permit to construct a facility shall be effective and valid for twenty-four (24) months upon issuance unless otherwise conditioned. If construction has not commenced within twenty-four (24) months following a permit's issuance, a new permit shall be obtained before construction may begin. [401 KAR 5:005 Section 24(1)] |
| T-4 | The permit is issued to the applicant, and the permittee shall remain the responsible party for compliance with all applicable statutes and administrative regulations until a notarized applicable change in ownership certification is submitted and the transfer of ownership is acknowledged by the cabinet. [401 KAR 5:005 Section 28(1)] |
| T-5 | The issuance of a permit by the cabinet does not convey any property rights of any kind or any exclusive privilege. [401 KAR 5:005 Section 24(5)] |
| T-6 | There shall be no deviations from the plans and specifications submitted with the application or the conditions specified, unless authorized in writing by the cabinet. [401 KAR 5:005 Section 24(3)(b)1] |

Sewer Line Construction
Guthrie WWTP
Facility Requirements

Activity ID No.:APE20180001

GACT000000003 (Novelis Sanitary Sewer Extension Project) 3771 linear feet of 12 inch DI sanitary sewer:

Narrative Requirements:

| Condition No. | Condition |
|---------------|--|
| T-7 | For subfluvial pipe crossings, a floodplain construction permit will not be required pursuant to KRS 151.250, if the following requirements of 401 KAR 4:050 Section 2 are met: <ol style="list-style-type: none"> 1) During the construction of the crossing, no material may be placed in the stream or in the flood plain of the stream to form construction pads, coffer dams, access roads, etc., unless prior approval has been obtained from the cabinet. 2) The trench shall be backfilled as closely as possible to the original contour. All excess material from construction of the trench shall be disposed of outside of the flood plain, unless the applicant has received prior approval from the cabinet to fill within the flood plain. 3) For subfluvial crossings of erodible channels, there shall be at least thirty (30) inches of clear cover above the top of the pipe or conduit at all points. 4) For subfluvial crossings of nonerodible channels, there shall be at least six (6) inches of clear cover above the top of the pipe or conduit at all points, and the pipe or conduit shall be encased on all sides by at least six (6) inches of concrete. 5) The weight of a pipe and its contents during normal operating conditions at all points must exceed that of an equal volume of water, or the applicant must provide the division with sufficient information to show that the pipe and joints have sufficient strength. <p>Contact the Floodplain Management Section of the Surface Water Permits Branch at (502) 564-3410 with any question on these requirements. [KRS 151.250 & 401 KAR 4:060]</p> |
| T-8 | If any portion of the sewer project will be constructed in or along a stream or wetland, contact the Water Quality Certification Section, located within the Water Quality Branch, at 502-564-3410, to determine if a 401 certification will be required. [KRS 224.16-050] |
| T-9 | Facilities shall be designed and constructed in accordance with the "Recommended Standards for Wastewater Facilities" of the Great Lakes-Upper Mississippi River Board of State Public Health and Environmental Managers, commonly referred to as "Ten States' Standards", 2004 edition. [401 KAR 5:005 Section 7(1)(a)] |
| T-10 | Gravity sewer lines and force mains shall be designed and constructed to give mean velocities, when flowing full, of not less than two (2) feet per second. Velocity calculations shall incorporate roughness coefficients pursuant to 401 KAR 5:005 Section 8(8). [401 KAR 5:005 Section 8(8)] |
| T-11 | Sewer line pipe material, joints, fittings, and installation shall conform to the latest ASTM specifications. [Ten States (WW) 33.7-33.9] |
| T-12 | Gravity sewer lines and force mains shall have a minimum of thirty (30) inches of cover or provide comparable protection. [401 KAR 5:005 Section 8(9)] |

Sewer Line Construction
Guthrie WWTP
Facility Requirements

Activity ID No.:APE20180001

GACT0000000003 (Novelis Sanitary Sewer Extension Project) 3771 linear feet of 12 inch DI sanitary sewer:

Narrative Requirements:

| Condition No. | Condition |
|---------------|---|
| T-13 | Sewer lines crossing water mains shall be laid to provide a vertical distance of eighteen (18) inches between the outside of the water main and the outside of the sewer line. This shall be the case where the water main is either above or below the sewer line. The crossing shall be arranged so that the sewer line joints are equidistant and as far as possible from the water main joints. Where a water main crosses under a sewer, adequate structural support shall be provided for the sewer line to prevent damage to the water main. [Ten States (WW) 38.32] |
| T-14 | Sewer lines shall be laid at least ten (10) feet horizontally from any existing or proposed water main. The distance shall be measured from edge to edge. [Ten States (WW) 38.31] |
| T-15 | If gravity sewer lines and force mains are to be constructed in fill areas, the fill areas shall be compacted to ninety-five (95) percent density as determined by the Standard Proctor Density test or to a minimum of ninety (90) percent density as determined by the Modified Proctor Density test prior to the installation of the sewer lines. [401 KAR 5:005 Section 8(10)] |

Sewer Line Construction
Guthrie WWTP
Facility Requirements

Activity ID No.: APE20180001

PORT0000000006 (Novelis Sanitary Sewer Extension Project) 3771 linear feet of 12 inch DI sanitary sewer:

Narrative Requirements:

| Condition No. | Condition |
|---------------|--|
| T-1 | The integrity of a new gravity sewer line shall be verified by either the infiltration-exfiltration or low pressure air testing method, and a deflection test shall be performed, if using flexible pipe. The deflection test shall be performed after the final backfill has been in place for at least thirty (30) days with no pipe exceeding a deflection of five (5) percent. Additionally, each new manhole shall be tested for water tightness. [401 KAR 5:005 Section 8(6)(a)] |
| T-2 | The entrance of groundwater into or loss of waste from a new gravity sewer line shall be limited to two-hundred (200) gpd per inch of diameter per mile of the gravity sewer line. This limitation includes manholes, gravity sewer lines, and appurtenances. [401 KAR 5:005 Section 8(5)] |



Eric Horton
Contract Specialist

500 Water Street, J180
Jacksonville, FL 32202
904.279.3806
Eric.Horton@csx.com

October 8, 2018

Chris Wilcutt
McGhee Engineering, Inc.
202 South Ewing Street
Guthrie, KY 42234

Agreement No.: CSX872690

Dated: September 7, 2018

Dear Chris Wilcutt,

Attached is the fully-executed Agreement of the above reference file.

In accordance with this Agreement, Agreement Holder is responsible for paying the actual cost of CSXT protection services and/or support services, including all applicable surcharges (collectively "Fees").

No work is to be performed on CSXT property without Roadmaster's authorization.

It is your responsibility to schedule any work on CSXT property with CSXT Outside Services. Please visit the CSX Property Portal to complete the Outside Party (OP) Application in order to have your work scheduled.

It was a pleasure assisting you with this project and we look forward to working with you in the future.

Should there be any questions, please feel free to give us a call at the above referenced number.

Sincerely,

Eric Horton

Attachment

FACILITY ENCROACHMENT AGREEMENT

THIS AGREEMENT, made and effective as of September 7, 2018, by and between CSX TRANSPORTATION, INC., a Virginia corporation, whose mailing address is 500 Water Street, Jacksonville, Florida 32202, hereinafter called "Licensor," and CITY OF GUTHRIE, a municipal corporation, political subdivision or state agency, under the laws of the Commonwealth of Kentucky, whose mailing address is 110 Kendall Street, Guthrie, Kentucky 42234, hereinafter called "Licensee," WITNESSETH:

WHEREAS, Licensee desires to construct (unless previously constructed and designated as existing herein), use and maintain the below described facility(ies), hereinafter called "Facilities," over, under or across property owned or controlled by Licensor, at the below described location(s):

1. One (1) twelve inch (12") diameter sub-grade pipeline crossing, solely for the conveyance of raw/treated sewage, located at or near Guthrie, Todd County, Kentucky, Nashville Division, Henderson Subdivision, Valuation Station 2141+13, Milepost 00H-216.5, Latitude N36:39:22.00, Longitude W87:10:23.00;

hereinafter, called the "Encroachment," as shown on print(s) labeled Exhibit "A," attached hereto and made a part hereof;

NOW, THEREFORE, in consideration of the mutual covenants, conditions, terms and agreements herein contained, the parties hereto agree and covenant as follows:

1. LICENSE:

1.1 Subject to Article 17, Licensor, insofar as it has the legal right, power and authority to do so, and its present title permits, and subject to:

(A) Licensor's present and future right to occupy, possess and use its property within the area of the Encroachment for any and all purposes;

(B) All encumbrances, conditions, covenants, easements, and limitations applicable to Licensor's title to or rights in the subject property; and

(C) Compliance by Licensee with the terms and conditions herein contained;

does hereby license and permit Licensee to construct, maintain, repair, renew, operate, use, alter or change the Facilities at the Encroachment above for the term herein stated, and to remove same upon termination.

1.2 The term Facilities, as used herein, shall include only those structures and ancillary facilities devoted exclusively to the transmission usage above within the Encroachment, and as shown on attached Exhibit A.

1.3 No additional structures or other facilities shall be placed, allowed, or maintained by Licensee in, upon or on the Encroachment except upon prior separate written consent of Licensor.

2. ENCROACHMENT FEE; TERM:

2.1 Licensee shall pay Licensor a one-time nonrefundable Encroachment Fee of FIVE THOUSAND ONE HUNDRED AND 00/100 U.S. DOLLARS (\$5,100.00) upon execution of this Agreement. Licensee agrees that the Encroachment Fee applies only to the original Licensee under this Agreement. In the event of a successor (by merger, consolidation, reorganization and/or assignment) or if the original Licensee changes its name, then Licensee shall be subject to payment of Licensor's current administrative and document preparation fees for the cost incurred by Licensor in preparing and maintaining this Agreement on a current basis.

2.2 However, Licensee assumes sole responsibility for, and shall pay directly (or reimburse Licensor), any additional annual taxes and/or periodic assessments levied against Licensor or Licensor's property solely on account of said Facilities or Encroachment.

2.3 This Agreement shall terminate as herein provided, but shall also terminate upon: (a) Licensee's cessation of use of the Facilities or Encroachment for the purpose(s) above; (b) removal of the Facilities; (c) subsequent mutual consent; and/or (d) failure of Licensee to complete installation within five (5) years from the effective date of this Agreement.

2.4 In further consideration for the license or right hereby granted, Licensee hereby agrees that Licensor shall not be charged or assessed, directly or indirectly, with any part of the cost of the installation of said Facilities and appurtenances, and/or maintenance thereof, or for any public works project of which said Facilities is a part.

3. CONSTRUCTION, MAINTENANCE AND REPAIRS:

3.1 Licensee shall construct, maintain, relocate, repair, renew, alter, and/or remove the Facilities, in a prudent, workmanlike manner, using quality materials and complying with any applicable standard(s) or regulation(s) of Licensor (CSXT Specifications), or Licensee's particular industry, National Electrical Safety Code, or any governmental or regulatory body having jurisdiction over the Encroachment.

3.2 Location and construction of Facilities shall be made strictly in accordance with design(s) and specifications furnished to and approved by Licensor and of material(s) and size(s) appropriate for the purpose(s) above recited.

3.3 All of Licensee's work, and exercise of rights hereunder, shall be undertaken at time(s) satisfactory to Licensor, and so as to eliminate or minimize any impact on or interference with the safe use and operation of Licensor's property and appurtenances thereto.

3.4 In the installation, maintenance, repair and/or removal of said Facilities, Licensee shall not use explosives of any type or perform or cause any blasting without the separate express written consent of Licensor. As a condition to such consent, a representative will be assigned by Licensor to monitor blasting, and Licensee shall reimburse Licensor for the entire cost and/or expense of furnishing said monitor.

3.5 Any repairs or maintenance to the Facilities, whether resulting from acts of Licensee, or natural or weather events, which are necessary to protect or facilitate Licensor's use of its property, shall be made by Licensee promptly, but in no event later than thirty (30) days after Licensee has notice as to the need for such repairs or maintenance.

3.6 Licensor, in order to protect or safeguard its property, rail operations, equipment and/or employees from damage or injury, may request immediate repair or renewal of the Facilities, and if the same is not performed, may make or contract to make such repairs or renewals, at the sole risk, cost and expense of Licensee.

3.7 Neither the failure of Licensor to object to any work done, material used, or method of construction or maintenance of said Encroachment, nor any approval given or supervision exercised by Licensor, shall be construed as an admission of liability or responsibility by Licensor, or as a waiver by Licensor of any of the obligations, liability and/or responsibility of Licensee under this Agreement.

3.8 All work on the Encroachment shall be conducted in accordance with Licensor's safety rules and regulations.

3.9 Licensee hereby agrees to reimburse Licensor any loss, cost or expense (including losses resulting from train delays and/or inability to meet train schedules) arising from any failure of Licensee to make repairs or conduct maintenance as required by Section 3.5 above or from improper or incomplete repairs or maintenance to the Facilities or Encroachment.

3.10 In the event it becomes necessary for the Licensee to deviate from the approved Exhibit, Licensee shall seek prior approval from Licensor, or when applicable, an official field representative of Licensor permitted to approve changes, authorizing the necessary field changes and Licensee shall provide Licensor with complete As-Built Drawings of the completed work. As-Built Drawings shall be submitted to Licensor in either electronic or hard copy form upon the substantial completion of the project and upon Licensor's request.

3.11 In the event of large scale maintenance/construction work to railroad bridges Licensee is required to protect power lines with insulated covers or comparable safety devices at their costs during construction/maintenance for safety of railroad employees.

4. PERMITS, LICENSES:

4.1 Before any work hereunder is performed, or before use of the Encroachment for the contracted purpose, Licensee, at its sole cost and expense, shall obtain all necessary permit(s) (including but not limited to zoning, building, construction, health, safety or

environmental matters), letter(s) or certificate(s) of approval. Licensee expressly agrees and warrants that it shall conform and limit its activities to the terms of such permit(s), approval(s) and authorization(s), and shall comply with all applicable ordinances, rules, regulations, requirements and laws of any governmental authority (State, Federal or Local) having jurisdiction over Licensee's activities, including the location, contact, excavation and protection regulations of the Occupational Safety and Health Act (OSHA) (29 CFR 1926.651(b)), et al., and State "One Call" - "Call Before You Dig" requirements.

4.2 Licensee assumes sole responsibility for failure to obtain such permit(s) or approval(s), for any violations thereof, or for costs or expenses of compliance or remedy.

5. MARKING AND SUPPORT:

5.1 With respect to any subsurface installation or maintenance upon Licensor's property, Licensee, at its sole cost and expense, shall:

- (A) support track(s) and roadbed in a manner satisfactory to Licensor;
- (B) backfill with satisfactory material and thoroughly tamp all trenches to prevent settling of surface of land and roadbed of Licensor; and
- (C) either remove any surplus earth or material from Licensor's property or cause said surplus earth or material to be placed and distributed at location(s) and in such manner Licensor may approve.

5.2 After construction or maintenance of the Facilities, Licensee shall:

- (A) Restore any track(s), roadbed and other disturbed property; and
- (B) Erect, maintain and periodically verify the accuracy of aboveground markers, in a form approved by Licensor, indicating the location, depth and ownership of any underground Facilities or related facilities.

5.3 Licensee shall be solely responsible for any subsidence or failure of lateral or subjacent support in the Encroachment area for a period of three (3) years after completion of installation.

6. TRACK CHANGES:

6.1 In the event that rail operations and/or track maintenance result in changes in grade or alignment of, additions to, or relocation of track(s) or other facilities, or in the event future use of Licensor's rail corridor or property necessitate any change of location, height or depth in the Facilities or Encroachment, Licensee, at its sole cost and expense and within thirty (30) days after notice in writing from Licensor, shall make changes in the Facilities or Encroachment to accommodate such track(s) or operations.

6.2 If Licensee fails to do so, Licensor may make or contract to make such changes at Licensee's cost.

7. FACILITY CHANGES:

7.1 Licensee shall periodically monitor and verify the depth or height of the Facilities or Encroachment in relation to the existing tracks and facilities, and shall relocate the Facilities or change the Encroachment, at Licensee's expense, should such relocation or change be necessary to comply with the minimum clearance requirements of Licensor.

7.2 If Licensee undertakes to revise, renew, relocate or change in any manner whatsoever all or any part of the Facilities (including any change in voltage or gauge of wire or any change in circumference, diameter or radius of pipe or change in materials transmitted in and through said pipe), or is required by any public agency or court order to do so, plans therefor shall be submitted to Licensor for approval before such change. After approval, the terms and conditions of this Agreement shall apply thereto.

8. INTERFERENCE WITH RAIL FACILITIES:

8.1 Although the Facilities/Encroachment herein permitted may not presently interfere with Licensor's railroad or facilities, in the event that the operation, existence or maintenance of said Facilities, in the sole judgment of Licensor, causes: (a) interference (including, but not limited to, physical or interference from an electromagnetic induction, or interference from stray or other currents) with Licensor's power lines, communication, signal or other wires, train control system, or electrical or electronic apparatus; or (b) interference in any manner, with the operation, maintenance or use of the rail corridor, track(s), structures, pole line(s), devices, other property, or any appurtenances thereto; then and in either event, Licensee, upon receipt of written notice from Licensor of any such interference, and at Licensee's sole risk, cost and expense, shall promptly make such changes in its Facilities or installation, as may be required in the reasonable judgment of the Licensor to eliminate all such interference. Upon Licensee's failure to remedy or change, Licensor may do so or contract to do so at Licensee's sole cost.

8.2 Without assuming any duty hereunder to inspect the Facilities, Licensor hereby reserves the right to inspect same and to require Licensee to undertake repairs, maintenance or adjustments to the Facilities, which Licensee hereby agrees to make promptly, at Licensee's sole cost and expense.

9. RISK, LIABILITY, INDEMNITY:

With respect to the relative risk and liabilities of the parties, it is hereby agreed that:

9.1 To the fullest extent permitted by State law (constitutional or statutory, as amended), Licensee hereby agrees to, defend, indemnify, and hold Licensor harmless from and against any and all liability, loss, claim, suit, damage, charge or expense which Licensor may suffer, sustain, incur or in any way be subjected to, on account of death of or injury to any person

whomsoever (including officers, agents, employees or invitees of Licensor), and for damage to or loss of or destruction of any property whatsoever, arising out of, resulting from, or in any way connected with the construction, repair, maintenance, replacement, presence, existence, operations, use or removal of the Facilities or any structure in connection therewith, or restoration of premises of Licensor to good order or condition after removal, EXCEPT when proven to have been caused solely by the willful misconduct or gross negligence of Licensor. HOWEVER, to the fullest extent permitted by State law, during any period of actual construction, repair, maintenance, replacement or removal of the Facilities, wherein agents, equipment or personnel of Licensee are on the railroad rail corridor, Licensee's liability hereunder shall be absolute, irrespective of any joint, sole or contributory fault or negligence of Licensor.

9.2 Use of Licensor's rail corridor involves certain risks of loss or damage as a result of the rail operations. Notwithstanding Section 9.1, Licensee expressly assumes all risk of loss and damage to Licensee's Property or the Facilities in, on, over or under the Encroachment, including loss of or any interference with use or service thereof, regardless of cause, including electrical field creation, fire or derailment resulting from rail operations. For this Section, the term "Licensee's Property" shall include property of third parties situated or placed upon Licensor's rail corridor by Licensee or by such third parties at request of or for benefit of Licensee.

9.3 To the fullest extent permitted by State law, as above, Licensee assumes all responsibility for, and agrees to defend, indemnify and hold Licensor harmless from: (a) all claims, costs and expenses, including reasonable attorneys' fees, as a consequence of any sudden or nonsudden pollution of air, water, land and/or ground water on or off the Encroachment area, arising from or in connection with the use of this Encroachment or resulting from leaking, bursting, spilling, or any escape of the material transmitted in or through the Facilities; (b) any claim or liability arising under federal or state law dealing with either such sudden or nonsudden pollution of air, water, land and/or ground water arising therefrom or the remedy thereof; and (c) any subsidence or failure of lateral or subjacent support of the tracks arising from such Facilities leakage.

9.4 Notwithstanding Section 9.1, Licensee also expressly assumes all risk of loss which in any way may result from Licensee's failure to maintain either required clearances for any overhead Facilities or the required depth and encasement for any underground Facilities, whether or not such loss(es) result(s) in whole or part from Licensor's contributory negligence or joint fault.

9.5 Obligations of Licensee hereunder to release, indemnify and hold Licensor harmless shall also extend to companies and other legal entities that control, are controlled by, subsidiaries of, or are affiliated with Licensor, as well as any railroad that operates over the rail corridor on which the Encroachment is located, and the officers, employees and agents of each.

9.6 If a claim is made or action is brought against Licensor, and/or its operating lessee, for which Licensee may be responsible hereunder, in whole or in part, Licensee shall be

notified to assume the handling or defense of such claim or action; but Licensor may participate in such handling or defense.

9.7 Notwithstanding anything contained in this Agreement, the limitation of liability contained in the state statutes, as amended from time to time, shall not limit Licensor's ability to collect under the insurance policies required to be maintained under this Agreement.

10. INSURANCE:

10.1 Prior to commencement of surveys, installation or occupation of premises pursuant to this Agreement, Licensee shall procure and shall maintain during the continuance of this Agreement, at its sole cost and expense, a policy of

- (i) Statutory Worker's Compensation and Employers Liability Insurance with available limits of not less than ONE MILLION AND 00/100 U.S. DOLLARS (\$1,000,000.00).
- (ii) Commercial General Liability coverage (inclusive of contractual liability) with available limits of not less than FIVE MILLION AND 00/100 U.S. DOLLARS (\$5,000,000.00) in combined single limits for bodily injury and property damage and covering the contractual liabilities assumed under this Agreement and naming Licensor, and/or its designee, as additional insured. The evidence of insurance coverage shall be endorsed to provide for thirty (30) days' notice to Licensor, or its designee, prior to cancellation or modification of any policy. Mail CGL certificate, along with agreement, to CSX Transportation, Inc., Speed Code J180, 500 Water Street, Jacksonville, FL 32202. On each successive year, send certificate to RenewalCOI@csx.com.
- (iii) Business automobile liability insurance with available limits of not less than ONE MILLION AND 00/100 U.S. DOLLARS (\$1,000,000.00) combined single limit for bodily injury and/or property damage per occurrence naming Licensor, and/or its designee, as additional insured.
- (iv) The insurance policies must contain a waiver of subrogation against CSXT and its Affiliates, except where prohibited by law. All insurance companies must be A. M. Best rated A- and Class VII or better.
- (v) Such other insurance as Licensor may reasonably require.
- (vi) Licensee shall require its contractors to meet minimum insurance requirements above when performing work in relation to this agreement. Licensee will procure and review contractor's insurance certificates to confirm requirements are met. Licensor may request a copy of the insurance certificate.

10.2 If Licensee's existing CGL policy(ies) do(es) not automatically cover Licensee's contractual liability during periods of survey, installation, maintenance and continued occupation, a specific endorsement adding such coverage shall be purchased by Licensee. If said CGL policy is written on a "claims made" basis instead of a "per occurrence" basis, Licensee shall arrange for adequate time for reporting losses. Failure to do so shall be at Licensee's sole risk.

10.3 Licensor, or its designee, may at any time request evidence of insurance purchased by Licensee to comply with this Agreement. Failure of Licensee to comply with Licensor's request shall be considered a default by Licensee.

10.4 To the extent permitted by law and without waiver of the sovereign immunity of Licensee, securing such insurance shall not limit Licensee's liability under this Agreement, but shall be security therefor.

10.5 (A) In the event Licensee finds it necessary to perform construction or demolition operations within fifty feet (50') of any operated railroad track(s) or affecting any railroad bridge, trestle, tunnel, track(s), roadbed, overpass or underpass, Licensee shall: (a) notify Licensor; and (b) require its contractor(s) performing such operations to procure and maintain during the period of construction or demolition operations, at no cost to Licensor,

i) Railroad Protective Liability (RPL) Insurance, naming Licensor, and/or its designee, as Named Insured, written on the current ISO/RIMA Form (ISO Form No. CG 00 35 04 13) with limits of FIVE MILLION AND 00/100 U.S. DOLLARS (\$5,000,000.00) per occurrence for bodily injury and property damage, with at least TEN MILLION AND 00/100 U.S. DOLLARS (\$10,000,000.00) aggregate limit per annual policy period. The original of such RPL policy shall be sent to and approved by Licensor prior to commencement of such construction or demolition. Licensor reserves the right to demand higher limits.

OR

ii) The CGL policy shall include endorsement ISO CG 24 17 and the Auto Liability Policy shall include endorsement ISO CA 20 70 evidencing that coverage is provided for work within 50 feet of a railroad. If such endorsements are not included, RPL insurance must be provided.

(B) At Licensor's option, in lieu of purchasing RPL insurance or the 50 foot endorsements from an insurance company (but not CGL insurance), Licensee may pay Licensor, at Licensor's current rate at time of request, the cost of adding this Encroachment, or additional construction and/or demolition activities, to Licensor's Railroad Protective Liability (RPL) Policy for the period of actual construction. This coverage is offered at Licensor's discretion and may not be available under all circumstances.

10.6 Notwithstanding the provisions of Sections 10.1 and 10.2, Licensee, pursuant to State Statute(s), may self-insure or self-assume, in any amount(s), any contracted liability arising under this Agreement, under a funded program of self-insurance, which fund will respond to liability of Licensee imposed by and in accordance with the procedures established by law.

11. GRADE CROSSINGS; PROTECTION SERVICES:

11.1 Nothing herein contained shall be construed to permit Licensee or Licensee's contractor to move any vehicles or equipment over the track(s), except at public road crossing(s), without separate prior written approval of Licensor.

11.2 If Licensor deems it advisable, during any construction, maintenance, repair, renewal, alteration, change or removal of said Facilities, to place watchmen, flagmen, or field construction managers for protection of operations of Licensor or others on Licensor's rail corridor at the Encroachment, and to keep persons, equipment or materials away from the track(s), Licensor shall have the right to do so at the expense of Licensee, but Licensor shall not be liable for failure to do so.

12. LICENSOR'S COSTS:

12.1 Any additional or alternative costs or expenses incurred by Licensor to accommodate Licensee's continued use of Licensor's property as a result of track changes or wire changes shall also be paid by Licensee.

12.2 Licensor's expense for wages ("force account" charges) and materials for any work performed at the expense of Licensee pursuant hereto shall be paid by Licensee within thirty (30) days after receipt of Licensor's bill therefor. Licensor may, at its discretion, request an advance deposit for estimated Licensor costs and expenses.

12.3 Such expense shall include, but not be limited to, cost of railroad labor and supervision under "force account" rules, plus current applicable overhead percentages, the actual cost of materials, and insurance, freight and handling charges on all material used. Equipment rentals shall be in accordance with Licensor's applicable fixed rate. Licensor may, at its discretion, require advance deposits for estimated costs of such expenses and costs.

13. DEFAULT, BREACH, WAIVER:

13.1 The proper and complete performance of each covenant of this Agreement shall be deemed of the essence thereof, and in the event Licensee fails or refuses to fully and completely perform any of said covenants or remedy any breach within thirty (30) days after receiving written notice from Licensor to do so (or within forty-eight (48) hours in the event of notice of a railroad emergency), Licensor shall have the option of immediately revoking this Agreement and the privileges and powers hereby conferred, regardless of encroachment fee(s) having been paid in advance for any annual or other period. Upon such revocation, Licensee shall make removal in accordance with Article 14.

13.2 No waiver by Licensor of its rights as to any breach of covenant or condition herein contained shall be construed as a permanent waiver of such covenant or condition, or any subsequent breach thereof, unless such covenant or condition is permanently waived in writing by Licensor.

13.3 Neither the failure of Licensor to object to any work done, material used, or method of construction or maintenance of said Encroachment, nor any approval given or supervision exercised by Licensor, shall be construed as an admission of liability or responsibility by Licensor, or as a waiver by Licensor of any of the obligations, liability and/or responsibility of Licensee under this Agreement.

14. TERMINATION, REMOVAL:

14.1 All rights which Licensee may have hereunder shall cease upon the date of (a) termination, (b) revocation, or (c) subsequent agreement, or (d) Licensee's removal of the Facility from the Encroachment. However, neither termination nor revocation of this Agreement shall affect any claims and liabilities which have arisen or accrued hereunder, and which at the time of termination or revocation have not been satisfied; neither party, however, waiving any third party defenses or actions.

14.2 Within thirty (30) days after revocation or termination, Licensee, at its sole risk and expense, shall (a) remove the Facilities from the rail corridor of Licensor, unless the parties hereto agree otherwise, (b) restore the rail corridor of Licensor in a manner satisfactory to Licensor, and (c) reimburse Licensor any loss, cost or expense of Licensor resulting from such removal.

15. NOTICE:

15.1 Licensee shall give Licensor at least thirty (30) days written notice before doing any work on Licensor's rail corridor, except that in cases of emergency shorter notice may be given. Licensee shall provide proper notification as follows:

a. For non-emergencies, Licensee shall submit online via the CSX Property Portal from Licensor's web site, via web link:
https://propertyportal.csx.com/pub_ps_res/ps_res/jsf/public/index.faces

b. For emergencies, Licensee shall complete all of the steps outlined in Section 15.1 a. above, and shall also include detailed information of the emergency. Licensee shall also call and report details of the emergency to Licensor's Rail Operations Emergency Telephone Number: 1-800-232-0144. In the event Licensor needs to contact Licensee concerning an emergency involving Licensee's Facility(ies), the emergency phone number for Licensee is: 270-483-2511.

15.2 All other notices and communications concerning this Agreement shall be addressed to Licensee at the address above, and to Licensor at the address shown on Page 1, c/o CSXT Contract Management, J180; or at such other address as either party may designate in writing to the other.

15.3 Unless otherwise expressly stated herein, all such notices shall be in writing and sent via Certified or Registered Mail, Return Receipt Requested, or by courier, and shall be considered delivered upon: (a) actual receipt, or (b) date of refusal of such delivery.

16. ASSIGNMENT:

16.1 The rights herein conferred are the privileges of Licensee only, and Licensee shall obtain Licensor's prior written consent to any assignment of Licensee's interest herein; said consent shall not be unreasonably withheld.

16.2 Subject to Sections 2 and 16.1, this Agreement shall be binding upon and inure to the benefit of the parties hereto and their respective successors or assigns.

16.3 Licensee shall give Licensor written notice of any legal succession (by merger, consolidation, reorganization, etc.) or other change of legal existence or status of Licensee, with a copy of all documents attesting to such change or legal succession, within thirty (30) days thereof.

16.4 Licensor expressly reserves the right to assign this Agreement, in whole or in part, to any grantee, lessee, or vendee of Licensor's underlying property interests in the Encroachment, upon written notice thereof to Licensee.

16.5 In the event of any unauthorized sale, transfer, assignment, sublicense or encumbrance of this Agreement, or any of the rights and privileges hereunder, Licensor, at its option, may revoke this Agreement by giving Licensee or any such assignee written notice of such revocation; and Licensee shall reimburse Licensor for any loss, cost or expense Licensor may incur as a result of Licensee's failure to obtain said consent.

17. TITLE:

17.1 Licensee understands that Licensor occupies, uses and possesses lands, rights-of-way and rail corridors under all forms and qualities of ownership rights or facts, from full fee simple absolute to bare occupation. Accordingly, nothing in this Agreement shall act as or be deemed to act as any warranty, guaranty or representation of the quality of Licensor's title for any particular Encroachment or segment of Rail Corridor occupied, used or enjoyed in any manner by Licensee under any rights created in this Agreement. It is expressly understood that Licensor does not warrant title to any Rail Corridor and Licensee will accept the grants and privileges contained herein, subject to all lawful outstanding existing liens, mortgages and superior rights in and to the Rail Corridor, and all leases, licenses and easements or other interests previously granted to others therein.

17.2 The term "license," as used herein, shall mean with regard to any portion of the Rail Corridor which is owned by Licensor in fee simple absolute, or where the applicable law of the State where the Encroachment is located otherwise permits Licensor to make such grants to Licensee, a "permission to use" the Rail Corridor, with dominion and control over such portion of the Rail Corridor remaining with Licensor, and no interest in or exclusive right to possess being otherwise granted to Licensee. With regard to any other portion of Rail Corridor occupied, used or controlled by Licensor under any other facts or rights, Licensor merely waives its exclusive right to occupy the Rail Corridor and grants no other rights whatsoever under this

Agreement, such waiver continuing only so long as Licensor continues its own occupation, use or control. Licensor does not warrant or guarantee that the license granted hereunder provides Licensee with all of the rights necessary to occupy any portion of the Rail Corridor. Licensee further acknowledges that it does not have the right to occupy any portion of the Rail Corridor held by Licensor in less than fee simple absolute without also receiving the consent of the owner(s) of the fee simple absolute estate. Further, Licensee shall not obtain, exercise or claim any interest in the Rail Corridor that would impair Licensor's existing rights therein.

17.3 Licensee agrees it shall not have nor shall it make, and hereby completely and absolutely waives its right to, any claim against Licensor for damages on account of any deficiencies in title to the Rail Corridor in the event of failure or insufficiency of Licensor's title to any portion thereof arising from Licensee's use or occupancy thereof.

17.4 Licensee agrees to fully and completely indemnify and defend all claims or litigation for slander of title, overburden of easement, or similar claims arising out of or based upon the Facilities placement, or the presence of the Facilities in, on or along any Encroachment(s), including claims for punitive or special damages.

17.5 Licensee shall not at any time own or claim any right, title or interest in or to Licensor's property occupied by the Encroachments, nor shall the exercise of this Agreement for any length of time give rise to any right, title or interest in Licensee to said property other than the license herein created.

17.6 Nothing in this Agreement shall be deemed to give, and Licensor hereby expressly waives, any claim of ownership in and to any part of the Facilities.

17.7 Licensee shall not create or permit any mortgage, pledge, security, interest, lien or encumbrances, including without limitation, tax liens and liens or encumbrances with respect to work performed or equipment furnished in connection with the construction, installation, repair, maintenance or operation of the Facilities in or on any portion of the Encroachment (collectively, "Liens or Encumbrances"), to be established or remain against the Encroachment or any portion thereof or any other Licensor property.

17.8 In the event that any property of Licensor becomes subject to such Liens or Encumbrances, Licensee agrees to pay, discharge or remove the same promptly upon Licensee's receipt of notice that such Liens or Encumbrances have been filed or docketed against the Encroachment or any other property of Licensor; however, Licensee reserves the right to challenge, at its sole expense, the validity and/or enforceability of any such Liens or Encumbrances.

18. GENERAL PROVISIONS:

18.1 This Agreement, and the attached specifications, contains the entire understanding between the parties hereto.

18.2 Neither this Agreement, any provision hereof, nor any agreement or provision included herein by reference, shall operate or be construed as being for the benefit of any third person.

18.3 Except as otherwise provided herein, or in any Rider attached hereto, neither the form of this Agreement, nor any language herein, shall be interpreted or construed in favor of or against either party hereto as the sole drafter thereof.

18.4 This Agreement is executed under current interpretation of applicable Federal, State, County, Municipal or other local statute, ordinance or law(s). However, each separate division (paragraph, clause, item, term, condition, covenant or agreement) herein shall have independent and severable status for the determination of legality, so that if any separate division is determined to be void or unenforceable for any reason, such determination shall have no effect upon the validity or enforceability of each other separate division, or any combination thereof.

18.5 This Agreement shall be construed and governed by the laws of the state in which the Facilities and Encroachment are located.

18.6 If any amount due pursuant to the terms of this Agreement is not paid by the due date, it will be subject to Licensor's standard late charge and will also accrue interest at eighteen percent (18%) per annum, unless limited by local law, and then at the highest rate so permitted.

18.7 Licensee agrees to reimburse Licensor for all reasonable costs (including attorney's fees) incurred by Licensor for collecting any amount due under the Agreement.

18.8 The provisions of this License are considered confidential and may not be disclosed to a third party without the consent of the other party(s), except: (a) as required by statute, regulation or court order, (b) to a parent, affiliate or subsidiary company, (c) to an auditing firm or legal counsel that are agreeable to the confidentiality provisions, or (d) to Lessees of Licensor's land and/or track who are affected by the terms and conditions of this Agreement and will maintain the confidentiality of this Agreement.

18.9 Within thirty (30) days of an overpayment in a cumulative total amount of One Hundred Dollars (\$100.00) or more by Licensee to Licensor, Licensee shall notify Licensor in writing with documentation evidencing such overpayment. Licensor shall refund the actual amount of Licensee's overpayment within 120 days of Licensor's verification of such overpayment.

19. **RESERVED:**

20. **RESERVED:**

21. **RIDERS:**

21.1 The following Rider(s) is/are herewith attached and included herein:

Telecommunication Cable or Fiber Optic Line

[REMAINDER OF PAGE INTENTIONALLY LEFT BLANK]

IN WITNESS WHEREOF, the parties hereto have executed this Agreement in duplicate
(each of which shall constitute an original) as of the effective date of this Agreement.

Witness for Licensor:

CSX TRANSPORTATION, INC.

EH

By: [Signature]

Print/Type Name: Donna Jabis

Print/Type Title: Sr Manager Real Estate Services

Witness for Licensee:

CITY OF GUTHRIE

Patricia Shepherd

By: A. Scott Marshall

Who, by the execution hereof, affirms that he/she has
the authority to do so and to bind the Licensee to the
terms and conditions of this Agreement.

Print/Type Name: A. Scott Marshall

Print/Type Title: Mayor

Tax ID No.: 61-6001835

Authority under Ordinance or

Resolution No. _____,

Dated _____.

COMMUNICATIONS CABLE OR FIBER OPTIC LINE PROTECTION RIDER

This Rider is and shall be a part of Agreement No. CSX872690, and is incorporated therein.

1. No construction of any type pursuant or related in any way to this Agreement shall be commenced by Licensee, or by any agent, representative, contractor, subcontractor of Licensee, without Licensee first giving at least thirty (30) days written notice to the following Parallel Cable Occupier(s):

("Verizon") ATTN:
Mr. Dean Boyers
Verizon Business
Wireline Network Ops & Eng
400 International Pkwy, Room N/A
Richardson, TX USA 75081
Phone No. (469) 886-4238 (Work)
or dean.boyers@verizon.com

(NOTE: WRITTEN NOTICE TO VERIZON IS ALSO REQUIRED)

2. The notice shall be accompanied by drawing(s) showing the general plan, elevation, details and methods of Licensee's proposed construction, and the location of Occupier(s)' cable or facilities in relation to Licensee's proposed construction.

3. Prior to any construction, Licensee must locate and identify, any existing cable, wire or fiber optic line (including any appurtenances thereto) of said cable occupier(s) traversing or located in, on, or immediately adjacent to the proposed Crossing, at Licensee's sole risk.

4. Any changes, alteration, relocation or protection of wire(s), cable(s) or facilities of such Occupier(s), required by said Occupier(s), shall be at Licensee's sole expense except as otherwise negotiated between Licensee and said Occupier(s).

5. Licensee shall be solely responsible and liable for any damage to (e.g., cutting, dislocating, etc.) said wire(s) or cable(s), and appurtenances thereto, resulting in any way from Licensee's exercise of rights or privileges under this Agreement.

6. Licensee shall defend, indemnify and hold Licensor harmless from any such damage claims and any relocation or protection costs of said Occupier(s).

CSX-872690 EXHIBIT A

Guthrie, Todd Co., KY
Southwest Region / Nashville Zone / Henderson (HE) Subdivision Milepost
00H-216.5

Val. Sta. 2141+13 (GIS Map No. 20135)
N36:39:22.00 / W87:10:23.00

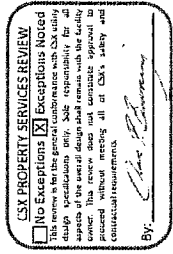

CSX GENERAL NOTES:

1. REFER TO THE CSX PIPELINE DESIGN & CONSTRUCTION SPECIFICATIONS FOR ADDITIONAL INFORMATION.
2. THE FRONT OF THE PIPE SHALL BE PROVIDED WITH MECHANICAL ARRANGEMENTS OR DEVICES THAT WILL POSITIVELY PREVENT THE AUGER FROM LEADING THE PIPE SO THAT NO UNSUPPORTED EXCAVATION IS AHEAD OF THE PIPE.
3. THE OPERATION SHALL BE PROCEEDED ON A 24-HOUR BASIS WITHOUT STOPPAGE (EXCEPT FOR ADDING LENGTHS OF PIPE) UNTIL THE LEADING EDGE OF THE PIPE HAS REACHED THE RECEIVING PIT.
4. THE AUGER AND CUTTING HEAD ARRANGEMENT SHALL BE REMOVABLE FROM WITHIN THE PIPE IN THE EVENT AN OBSTRUCTION IS ENCOUNTERED.
5. PIPELINE SHALL BE PROMINENTLY MARKED AT BOTH SIDES OF THE CSX PROPERTY LINES BY DURABLE, WEATHERPROOF SIGNS LOCATED OVER THE CENTERLINE OF THE PIPE IN ACCORDANCE WITH CSX SPECIFICATIONS.
6. NO CONSTRUCTION OR ENTRY UPON THE CSX CORRIDOR IS PERMITTED UNTIL THE DOCUMENT TRANSACTION IS COMPLETED, YOU ARE IN RECEIPT OF A FULLY EXECUTED DOCUMENT, AND YOU HAVE OBTAINED AUTHORITY FROM THE LOCAL ROADMASTER.
7. IF REQUIRED, A DEWATERING PLAN IN ACCORDANCE WITH CSX SPECIFICATIONS WILL BE SUBMITTED TO THE CSX REPRESENTATIVE FOR REVIEW AND APPROVAL PRIOR TO ANY DEWATERING OPERATIONS.
8. BLASTING IS NOT PERMITTED UNDER OR ON CSX PROPERTY.
9. CSX DOES NOT GRANT OR CONVEY AN EASEMENT FOR THIS INSTALLATION.
10. ALL PERSONNEL SHALL RECEIVE SAFETY BRIEFINGS BY A CSXT FLAGMAN OR DESIGNATED CSXT REPRESENTATIVE EACH DAY BEFORE BEGINNING WORK ON THE RIGHT OF WAY. ADDITIONAL SAFETY BRIEFINGS MAY BE REQUIRED WHEN CONDITIONS AND/OR WORK SITES ARE CHANGED.
11. AGENCY OR ITS CONTRACTOR SHALL ARRANGE AND CONDUCT ITS WORK SO THAT THERE WILL BE NO INTERFERENCE WITH CSXT OPERATIONS, INCLUDING TRAIN, SIGNAL, TELEPHONE AND TELEGRAPHIC SERVICES, OR DAMAGES TO CSXT'S PROPERTY, OR TO POLES, WIRES, AND OTHER FACILITIES OF TENANTS OF CSXT'S PROPERTY OR RIGHT-OF-WAY.
12. CONTRACTOR MUST CONDUCT ALL OF ITS WORK IN A SAFE MANNER. ALL WORK SHALL BE PERFORMED IN ACCORDANCE WITH RULES, REGULATIONS, PROCEDURES AND SAFE PRACTICES OF CSXT, OSHA, THE FRA AND ALL OTHER GOVERNMENT AGENCIES HAVING JURISDICTION OVER THE PROJECT.
13. OWNER SHALL REIMBURSE CSXT DIRECTLY FOR ALL COSTS OF FLAGGING AND INSPECTION SERVICE THAT ARE REQUIRED ON ACCOUNT OF CONSTRUCTION WITHIN CSXT PROPERTY SHOWN IN THE PLANS, OR COVERED BY AN APPROVED PLAN, REVISION, SUPPLEMENTAL AGREEMENT OR CHANGE ORDER. INSPECTION SERVICE SHALL NOT RELIEVE CONTRACTOR FROM LIABILITY FOR ITS WORK.
14. OWNER OR CONTRACTOR SHALL GIVE A MINIMUM OF 30 DAYS' ADVANCE NOTICE TO CSXT REPRESENTATIVE FOR ANTICIPATED NEED FOR FLAGGING AND INSPECTION SERVICE. NO WORK SHALL BE UNDERTAKEN UNTIL THE FLAG PERSON(S) AND INSPECTOR(S) IS/ARE AT THE JOB SITE. IF IT IS NECESSARY FOR CSXT TO ADVERTISE A FLAGGING JOB FOR BID, CSXT SHALL NOT BE LIABLE FOR THE COST OF DELAYS ATTRIBUTABLE TO OBTAINING SUCH SERVICE.
15. THE RIGHT OF WAY SHALL BE RESTORED TO A CONDITION EQUAL TO OR BETTER THAN THE CONDITION PRIOR TO BEGINNING THE PROJECT BEFORE FINAL ACCEPTANCE WILL BE PROVIDED. PUNCH LISTS SHALL BE RESPONDED TO PRIOR TO ISSUANCE OF AN ACCEPTANCE MEMORANDUM SIGNED BY THE CSXT REPRESENTATIVE.
16. CONTRACTOR ALSO HAS THE SOLE RESPONSIBILITY OF ASCERTAINING THAT ALL OTHER UTILITIES HAVE BEEN PROPERLY LOCATED BY THE LOCAL "CALL BEFORE YOU DIG" REGULATION(S). CONTRACTOR SHALL SOLELY BE RESPONSIBLE FOR NOTIFYING OWNERS OF ADJACENT PROPERTIES AND OF UNDERGROUND FACILITIES AND UTILITY OWNERS WHEN PROSECUTION OF THE WORK MAY AFFECT THEM, AND SHALL COOPERATE WITH THEM IN THE PROTECTION, REMOVAL, RELOCATION AND REPLACEMENT OF THEIR PROPERTY.
17. CONTRACTOR SHALL ESTABLISH APPROPRIATE LAYDOWN AREAS, PLACE SNOW FENCE AROUND EXCAVATION PITS, APPLY LAYER (6" MIN.) OF WASHED STONE TO BASE OF EXCAVATION TO ESTABLISH PROPER LINE AND GRADE, AND USE BEST MANAGEMENT PRACTICES FOR ALL EROSION CONTROL MEASURES.

EXCEPTIONS NOTED:

1. SUITABLE ACCESS ROADS AS NECESSARY SHALL BE PROVIDED AT THE EXPENSE OF THE CONTRACTOR TO PROVIDE INGRESS AND EGRESS TO THE SITE OF THE WORK. THE CONTRACTOR SHALL ALSO PROVIDE AND/OR MAINTAIN ANY PUBLIC OR PRIVATE ROADS HE MAY USE IN THE PROCESS OF THE WORK. ANY CONTRACTOR CAUSED DAMAGE THAT MAY OCCUR TO THESE ROADS IS THE RESPONSIBILITY OF THE CONTRACTOR TO REPAIR AT CONTRACTOR'S EXPENSE.
2. THE TOE OF SLOPES IN EXCAVATION SHALL IN NO CASE BE UNDERCUT BY POWER SHOVELS, BULLDOZERS, GRADERS, BLASTING, OR IN ANY MANNER. EXCAVATION SHALL NOT BE MADE IN EXCESS OF THE AUTHORIZED CROSS-SECTION.
3. CONTRACTOR SHALL MONITOR FOR SETTLEMENT OF THE TRACKS DURING THE INSTALLATION. A TOP OF RAIL BASELINE SURVEY SHOULD BE CONDUCTED BEFORE THE START OF CONSTRUCTION.

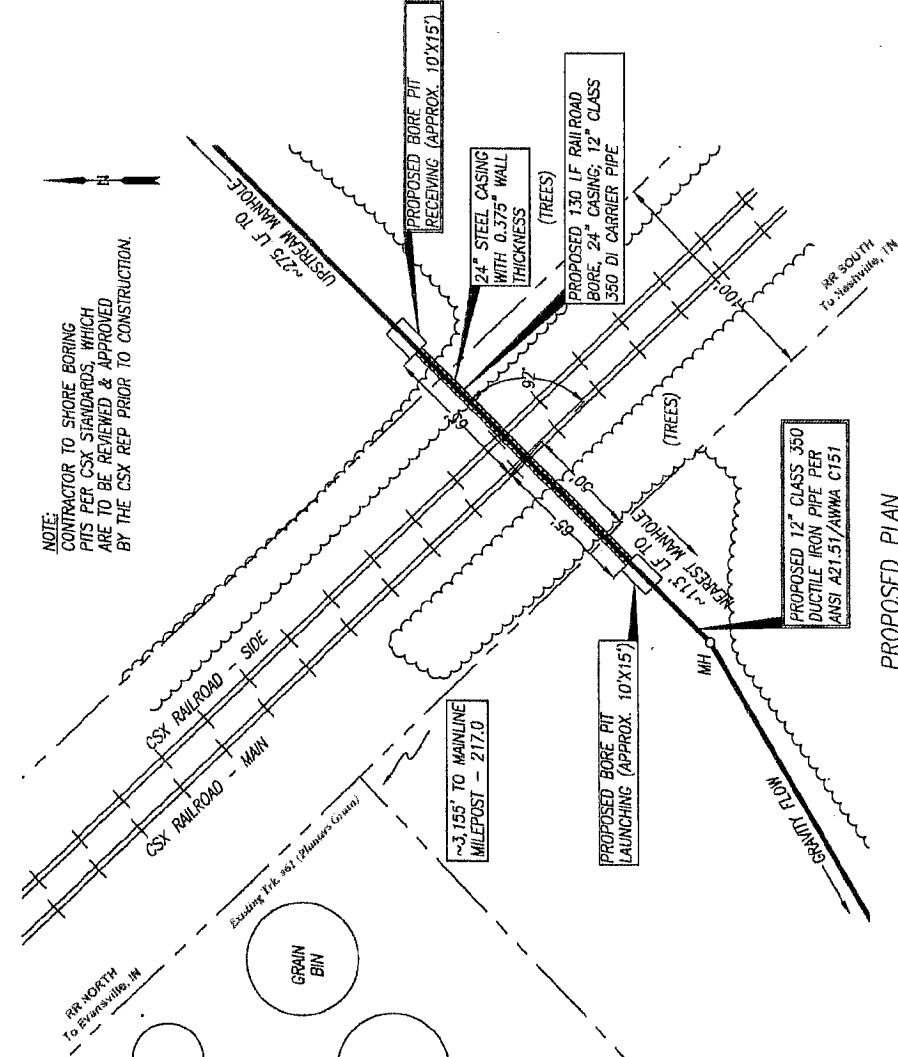

NOTES:
 THE FRONT OF THE CASING PIPE SHALL BE PROVIDED WITH MECHANICAL ARRANGEMENTS OR DEVICES THAT WILL POSITIVELY PREVENT THE AUGER FROM LEADING THE PIPE SO THAT NO UNSUPPORTED EXCAVATION IS AHEAD OF THE PIPE.
 CASING PIPE ENDS WILL BE SEALED IN ACCORDANCE WITH CSXT SPECS.
 FOR ANY EXCAVATED SOIL THAT REQUIRES OFF-SITE DISPOSAL, THE LICENSEE IS REQUIRED TO USE ONLY CSX APPROVED LABORATORIES, TRANSPORTERS AND DISPOSAL FACILITIES. ALL DISPOSAL-RELATED DOCUMENTS (MANIFEST, PROFILE, ETC.) MUST GO THROUGH THE CSX DISPOSAL APPROVAL PROCESS, MANAGED BY CCR ENVIRONMENTAL SOLUTIONS LLC. CONTRACTOR MUST HAVE THE WRITTEN APPROVAL FROM THE CSX ENVIRONMENTAL DEPARTMENT. CONTACT THE CSXT FIELD REPRESENTATIVE. UTILITY MARKER SIGNS SHALL BE PLACED IN ACCORDANCE WITH CSX SPECIFICATIONS.

NOTE:
 CONTRACTOR TO SHORE BORING PITS PER CSX STANDARDS, WHICH ARE TO BE REVIEWED & APPROVED BY THE CSX REP PRIOR TO CONSTRUCTION.

August 16, 2018



Chris Wilcutt
 Chris Wilcutt, P.E.

LAT: 36.656226N
 LONG: 87.173136W

MCGHEE ENGINEERING, INC.
 200 South Perry Street
 Guthrie, Kentucky 40343
 Phone: (270) 443-9688
 Fax: (270) 443-9689
 www.mcgheehill.com

CITY OF GUTHRIE, KENTUCKY
 WATER & SEWER
 115 West 1st Street
 Guthrie, KY 40343
 Phone: (270) 445-2911

Proposed Railroad Crossing - PLAN
 Guthrie, Kentucky
 Date: August 2018
 Scale: 1" = 50'
 Sheet: 2 of 2

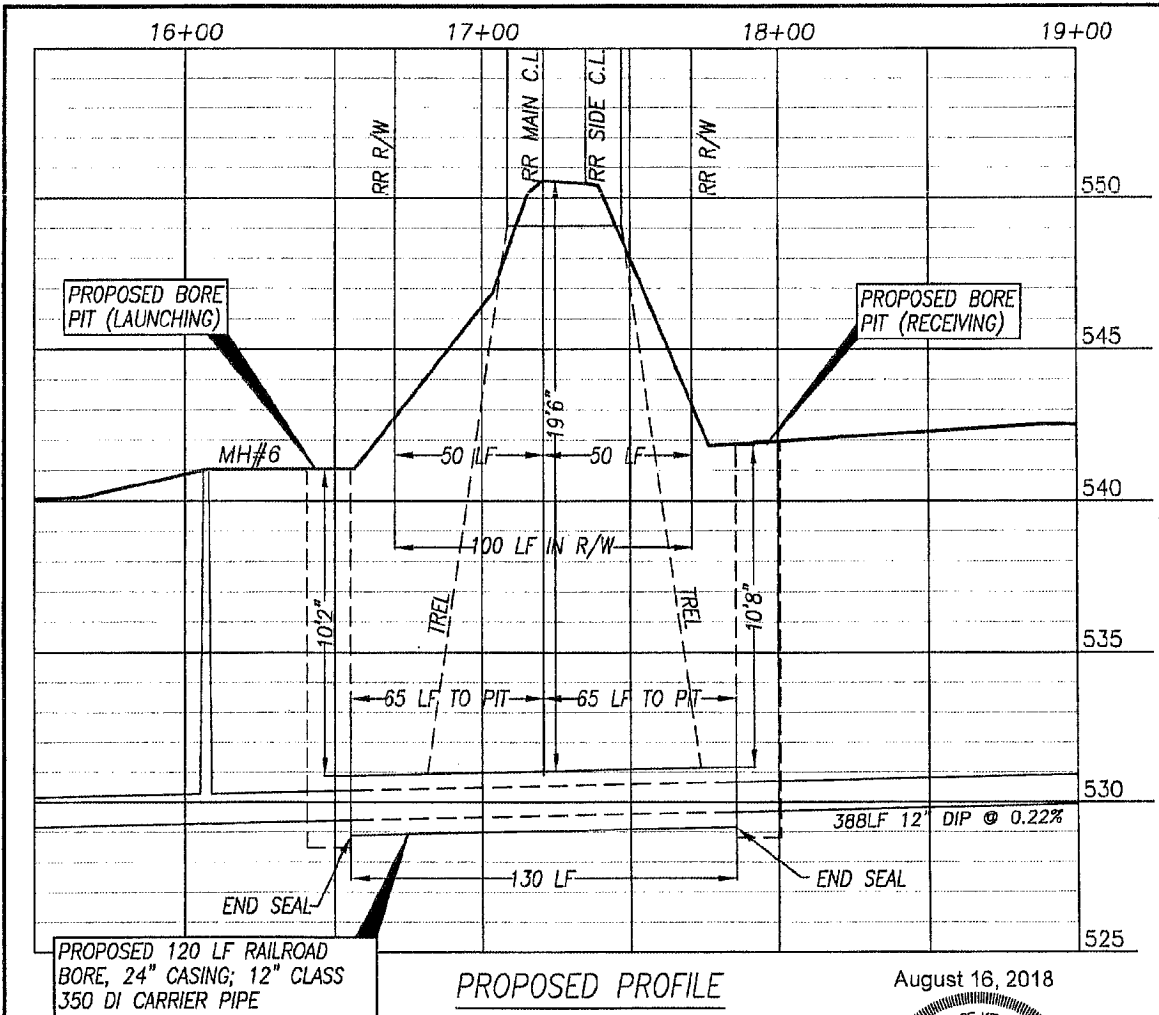

PROPOSED PROFILE

August 16, 2018

| PIPELINE CONTENT DETAILS | | | |
|---|---|--|-------------|
| Commodity Description: | Gravity Sewer (Wastewater) | | |
| Maximum Operating Pressure: | 0 | | |
| Is Commodity Flammable: | <input type="checkbox"/> Yes | <input checked="" type="checkbox"/> No | |
| CARRIER/CASING PIPE DETAILS | | | |
| | Carrier Pipe | | Casing Pipe |
| Pipe Material: | Ductile Iron | Steel | |
| Material Specifications & Grade: | ANSI A21.5A/WWAC150 | ASTM | |
| Specified Minimum Yield Strength: | 42,000 | 35,000 PSI | |
| Nominal Size Outside Diameter (Inches): | 13.2 | 24 | |
| Wall Thickness (Inches): | .28 | .375 | |
| Type of Seam: | n/a | Weld | |
| Type of Joint: | Bell | Weld | |
| Canal Liner Plates Required: | <input type="checkbox"/> Yes | <input checked="" type="checkbox"/> No | |
| Cathodic Protection: | <input type="checkbox"/> Yes | <input checked="" type="checkbox"/> No | |
| Protective Coating: | <input checked="" type="checkbox"/> Yes | <input type="checkbox"/> No | |
| Temp. Track Support or Rip-Rap Req.: | <input type="checkbox"/> Yes | <input checked="" type="checkbox"/> No | |
| | | Type: Asphalt | |
| | | Must Describe & Show on Dwg. | |

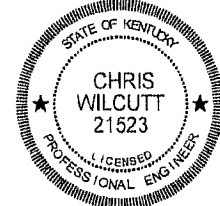

Chris Wilcutt

Chris Wilcutt, P.E.

CITY OF GUTHRIE, KENTUCKY
WATER & SEWER
 110 Kendall Street
 Guthrie, KY 42234 Phone: (270) 483-2511

Proposed Railroad Crossing - PROFILE
Guthrie, Kentucky



McGHEE ENGINEERING, INC.

Phone: (270) 483-9965
 Fax: (270) 483-9988
 www.mcgheengr.com

202 South Ewing Street
 P. O. Box 267
 Guthrie, Kentucky 42234

| Date | Prep. By | Scale | File No. | Sheet |
|-------------|------------|----------|----------|--------|
| August 2018 | C. Wilcutt | 1" = 50' | | 2 of 2 |



Kentucky Transportation Cabinet
 Department of Highways
 Division of Maintenance
 Permits Branch

TC 99-1 (B)
 07/2018
 Page 1 of 1

ENCROACHMENT PERMIT

KYTC KEPT #: 03-2018-00269

Permittee: City of Guthrie Water Works

Permit Type / Subtype: Utilities / Sewer

Work Completion Date: 9/30/2019

| INDEMNITIES | | |
|---------------------|-----------------|-----------------|
| Type | Amount Required | Tracking Number |
| Performance Bond | \$0.00 | |
| Cash / Check | \$0.00 | |
| Self-Insured | \$0.00 | |
| Payment Bond | \$0.00 | |
| Liability Insurance | \$0.00 | |

This permit has been: **APPROVED** **DENIED**

Sarah Payton D3 Permits - Supervisor 9/20/2018

SIGNATURE TITLE DATE

The TC 99-1(B), including the application TC-99 1(A) and all related and accompanying documents and drawings make up the permit. It is not a permit unless both the TC 99-1(A) and TC 99-1(B) are both present.

| LOCATION(S) | | | |
|-------------|----------------|-----------|------------|
| Description | County - Route | Latitude | Longitude |
| Sewer | Todd - US 79 | 36.657421 | -87.175941 |
| Sewer | Todd - KY 346 | 36.654340 | -87.174252 |



Know what's below. Call before you dig

To Submit a Locate Request
 24 Hours a Day, Seven Days a Week:
 Call 811 or 800-752-6007



Kentucky Transportation Cabinet
 Department of Highways
 Permits Branch

TC 99-1 (A)
 8/2012
 Page 1 of 4

APPLICATION FOR ENCROACHMENT PERMIT

| | | | | | | | |
|------------------------------|-------------------------------------|------|-------|---|---------------------------------------|---|-----------------------|
| Permittee Information | | | | KYTC No. <u>T03-2018-00269</u> | | | |
| Name | City of Guthrie Water Works | | | Permit Information | | | |
| Address | PO Box 125 | | | Address | 8535 Russellville Road | | |
| City | Guthrie | | | City | Guthrie | | |
| State | KY | Zip | 42234 | State | KY | Zip | 42234 |
| Phone# | 270-483-2511 | | | County | Todd | | |
| Contact | Scott Marshall | | | Route No. | US79 | Mile Point | 1.9 2.2 |
| Phone | 270-483-2511 | Cell | | Longitude (X) | -87.172461° | | -87.175941 <i>JMS</i> |
| Email | <u>guthriemayor@gmail.com</u> | | | Latitude (Y) | 36.659732° | | 36.657421 |
| Contact | Chris Wilcutt | | | Information below to be filled out by KYTC | | | |
| Phone | 270-426-9143 | Cell | | <input type="checkbox"/> Air Right | <input type="checkbox"/> Entrance | | |
| Email | chris.wilcutt@mcgheeengineering.com | | | <input checked="" type="checkbox"/> Utilities | <input type="checkbox"/> Other: _____ | | |
| | | | | <i>Sewer</i> | | | |
| | | | | <input checked="" type="checkbox"/> Left | <input type="checkbox"/> Right | <input checked="" type="checkbox"/> X-ing | |
| | | | | Access: <input type="checkbox"/> Full | <input type="checkbox"/> Partial | <input checked="" type="checkbox"/> by Permit | |

General Description of Work:

The City of Guthrie plans to extend gravity sewer approximately 3,800 LF as part of their Novelis Sanitary Sewer Extension Project. This Permit Form entails the City's plan to encroach a total of 200 LF across state right-of-way (US HIGHWAY 79) with a 70 LF road bore (24" steel casing; 12" DIP carrier). A copy of the plans for the proposed encroachment locations are attached to this application.

THE UNDERSIGNED PERMITTEE(s) (being duly authorized representative(s) or owner(s)) DO AGREE TO ALL TERMS AND CONDITIONS ON THE TC 99-1 (A).

A. Scott Marshall

Signature

9/4/18

Date

This is not a permit unless and until the permittee(s) receives an approved TC 99-1(B) from KYTC. This application will become void if not approved by the cancellation date. The cancellation date will be one year from the date the permittee submits their application.



Kentucky Transportation Cabinet
 Department of Highways
 Permits Branch

TC 99-1 (A)
 8/2012
 Page 1 of 4

APPLICATION FOR ENCROACHMENT PERMIT

| | | | |
|------------------------------|--|---|---|
| Permittee Information | | KYTC No. <u>T03-2018-00269</u> | |
| Name | City of Guthrie Water Works | Permit Information | |
| Address | PO Box 125 | Address | NW of 350 Ewing Street |
| City | Guthrie | City | Guthrie |
| State | KY | State | KY |
| Zip | 42234 | Zip | 42234 |
| Phone# | 270-483-2511 | County | Todd |
| Contact | Scott Marshall | Route No. | KY346 |
| Phone | 270-483-2511 | Mile Point | 0.6 |
| Email | <u>guthriemayor@gmail.com</u> | Longitude (X) | -87.174129° <u>-87.174252</u> |
| Contact | Chris Wilcutt | Latitude (Y) | 36.654265° <u>36.654340</u> |
| Phone | 270-426-9143 | <i>Information below to be filled out by KYTC</i> | |
| Email | <u>chris.wilcutt@mcgheeengineering.com</u> | <input type="checkbox"/> Air Right | <input type="checkbox"/> Entrance |
| | | <input type="checkbox"/> Utilities | <input type="checkbox"/> Other: _____ |
| | | <input checked="" type="checkbox"/> Left | <input checked="" type="checkbox"/> Right |
| | | | <input checked="" type="checkbox"/> X-ing |
| | | Access: | <input type="checkbox"/> Full |
| | | | <input type="checkbox"/> Partial |
| | | | <input type="checkbox"/> by Permit |

General Description of Work:

The City of Guthrie plans to extend gravity sewer approximately 3,800 LF as part of their Novelis Sanitary Sewer Extension Project. This Permit Form entails the City's plan to encroach a total of 170 LF across state right-of-way (KY HIGHWAY 346) with 80 LF road bore (24" steel casing; 12" DIP carrier) and approximately 100 LF parallel placement in R/W at Spring Creek. A copy of the plans for the proposed encroachment locations are attached to this application.

THE UNDERSIGNED PERMITTEE(s) (being duly authorized representative(s) or owner(s)) DO AGREE TO ALL TERMS AND CONDITIONS ON THE TC 99-1 (A).

A. Scott Marshall
 Signature

9/4/18
 Date

This is not a permit unless and until the permittee(s) receives an approved TC 99-1(B) from KYTC. This application will become void if not approved by the cancellation date. The cancellation date will be one year from the date the permittee submits their application.



APPLICATION FOR ENCROACHMENT PERMIT

TERMS AND CONDITIONS

1. The permit, including this application and all related and accompanying documents and drawings making up the permit, remains in effect and is binding upon the Applicant/Permittee, its successors and assigns, as long as the encroachment(s) exists and also until the permittee is finally relieved by the Department of Highways from all its obligations.
2. Applicant shall meet all requirements of the Clean Water Act if the project will disturb one acre or more, the applicant shall obtain a KPDES KYR10 Permit from the Kentucky Division of Water. All disturbed areas shall meet the requirements of the Department of Highway's Standard Specifications, Sections 212 and 213, as amended.
3. **INDEMNITY:**
 - A. **PERFORMANCE BOND:** The permittee shall provide to the Department a performance bond according to the Permits Manual, Section PE-203 as a guarantee of conformance with the Department's Encroachment Permit requirements.
 - B. **PAYMENT BOND:** At the discretion of the department, a payment bond will be required of the permittee to ensure payment of liquidated damages assessed to the permittee.
 - C. **LIABILITY INSURANCE:** Liability insurance will be required of the permittee (in an amount approved by the department) to cover all liabilities associated with the encroachment.
 - D. It shall be the responsibility of the permittee, its successors and assigns, to maintain all indemnities in full force and effect until the permittee is authorized to release the indemnity by the Department.
4. A copy of this application and all related documents making up the approved permit will be given to the applicant and shall be made readily available for review at the work site at all times.
5. Perpetual maintenance of the encroachment is the responsibility of the permittee, its successors and assigns, with the approval of the Department as required, unless otherwise stated.
6. Permittee, its successors and assigns, shall comply with and agrees to be bound by the requirements and terms of (a) this application and all related documents making up the approved permit, (b) by the Department's Permits Manual, and (c) by the Manual on Uniform Traffic Control Devices, both manuals as revised to and in effect on the date of issuance of the permit, all of which documents are made a part thereof by this reference. Compliance by the permittee, its successors and assigns, with subsequent revisions to applicable provisions of either manual or other policy of the Department may be made a condition of allowing the encroachment to persist under the permit.
7. Permittee agrees that this and any encroachment may be ordered removed by the Department at any time, and for any reason, upon thirty days written notice to the last known address of the applicant or to the address at the location of the encroachment. The permittee agrees that the cost of removing and of restoring the associated right-of-way is the responsibility of the permittee, its successors and assigns.
8. Permittee, its successors and assigns, agree that if the Department determines that motor vehicular safety deficiencies develop as a result of the installation or use of the encroachment, the permittee, its successors and assigns, shall provide and bear the expenses to adjust, relocate, or reconstruct the facilities, and/or add signs, auxiliary lanes, or other corrective measures reasonably deemed necessary by the Department within a reasonable time after receipt of a written notice of such deficiency. The period within which such adjustments, relocations, additions, modifications, and/or other corrective measures must be completed will be specified in the notice.
9. Where traffic signals are required as a condition of granting the requested permit or are thereafter required to correct motor vehicular safety deficiencies, as determined by the Department, the costs for signal equipment and



APPLICATION FOR ENCROACHMENT PERMIT

installation(s) shall be borne by the permittee, its successors and assigns, and/or the Department in its reasonable discretion and only in accordance with the Department's current policy set forth in the Traffic Operations Manual and Permits Manual. Any modifications to the permittee's entrance necessary to accommodate signalization (including necessary easement(s) on private property) shall be the responsibility of the permittee, its successors and assigns, at no expense to the Department.

10. The requested encroachment shall not infringe on the frontage rights of an abutting owner without their written consent as hereinafter described. Each abutting owner shall express their consent, which shall be binding on their successors and assigns, by the submission of a notarized statement as follows, "I _____ (we), _____ hereby consent to the granting of the permit requested by the applicant along Route _____, which permit does affect frontage rights along my (our) adjacent real property." By signature(s) _____ subscribed and sworn by _____, on this date _____.

11. The permit, if approved, is subject to the agreement that it shall not interfere with any similar rights or permit(s) previously granted to any other party, except as otherwise provided by law.

12. Permittee shall include documentation which describes the facilities to be constructed. Permittee, its successors and assigns, agrees as a condition of the granting of the permit to construct and maintain any and all permitted facilities or other encroachments in strict accordance with the submitted and approved permit documentation and the policies and procedures of the Department. Permittee, its successors and assigns, shall not use facilities authorized herein in any manner contrary to that prescribed by the approved permit. Only normal usage as contemplated by the parties and by this application and routine maintenance are authorized by the permit.

13. Permittee, its successors and assigns, at all times from the date permitted work is commenced until such time as all permitted facilities or other encroachments are removed from the right-of-way and the right-of-way restored, shall defend, protect, indemnify and save harmless the Department from any and all liability claims and demands arising out of the work, encroachment, maintenance, or other undertaking by the permittee, its successors and assigns, related or undertaken pursuant to the granted permit, due to any claimed act or omission by the permittee, its servants, agents, employees, or contractors. This provision shall not inure to the benefit of any third party nor operate to enlarge any liability of the Department beyond that existing at common law or otherwise if this right to indemnity did not exist.

14. Upon a violation of any provision of the permit, or otherwise in its reasonable discretion, the Department may require additional action by the permittee, its successors and assigns, up to and including the removal of the encroachment and restoration of the right-of-way. In the event additional actions required by the Department under the permit are not undertaken as ordered and within a reasonable time, the Department may in its discretion cause those or other additional corrective actions to be undertaken and the Department may and shall recover the reasonable costs of those corrective actions from the permittee, its successors and assigns.

15. Permittee, its successors and assigns, shall use the encroachment premises in compliance with all requirements of federal law and regulation, including those imposed pursuant to Title VI of the Civil Right Act of 1964 (42 U.S.C. § 2000d et seq.) and the related regulations of the U.S. Department of Transportation in Title 49 C.F.R. Part 21, all as amended.

16. Permittee, its successors and assigns, agree that if the Department determines it is necessary for the facilities or other encroachment authorized by the permit to be removed, relocated or reconstructed in connection with the reconstruction, relocation or improvement of a highway, the Department may revoke permission for the



Kentucky Transportation Cabinet
Department of Highways
Permits Branch

TC 99-1 (A)
8/2012
Page 4 of 4

APPLICATION FOR ENCROACHMENT PERMIT

encroachment to remain under the permit and may order its removal, relocation or reconstruction by the permittee, its successors and assigns, at the expense of the permittee, except where the Department is required by law to pay any or all of those costs.

17. Permittee agrees that the authorized permit is personal to the permittee and shall remain in effect until such time as (a) the permittee's rights to the adjoining real property to have benefitted from the requested encroachment have been relinquished, (b) until all permit obligations have been assumed by appropriate successors and assigns, and (c) unless and until a written release from permit obligations has been granted by the Department. The permit and its requirements shall also bind the real property to have benefitted from the requested encroachment to the extent permitted by law. The permit and the related encroachment become the responsibility of the successors and assigns of the permittee and the successors and assigns of each property owner benefitting from the encroachment, or the encroachment may not otherwise permissibly continue to be maintained on the right-of-way. (Does not apply to utility encroachments serving the general public.)

18. If work authorized by the permit is within a highway construction project in the construction phase, it shall be the responsibility of the permittee to make personal contact with the Department's Engineer on the project in order to coordinate all permitted work with the Department's prime contractor on the project.

19. This permit is not intended to, nor shall it, affect, alter or alleviate any requirement imposed upon the permittee, its successors and assigns, by any other agency.

20. Permittee, its successors and assigns, agrees to contain and maintain all dirt, mud, and other debris emanating from the encroachment away from the surrounding right-of-way and the travel way of the highway hereafter and at all times that its obligations under the permit remain in effect.

MATTHEW G. BEVIN
GOVERNOR



CHARLES G. SNAVELY
SECRETARY

ENERGY AND ENVIRONMENT CABINET
DEPARTMENT FOR ENVIRONMENTAL PROTECTION

ANTHONY R. HATTON
COMMISSIONER

300 SOWER BOULEVARD
FRANKFORT, KENTUCKY 40601

STREAM CONSTRUCTION PERMIT

For Construction In Or Along A Stream

Issued to: **City of Guthrie**
Address: **110 Kendall St**
Guthrie, KY 42234

Permit expires on
October 1, 2019

Permit No. **28232P**

AI: **4018**

In accordance with KRS 151.250 and KRS 151.260, the Energy and Environment Cabinet approves the application dated **September 17, 2018** for **subfluvial crossings by 'open cut' method at coordinate 36.654473, -87.174265 in conjunction with approximately 3800 LF of 12-inch sewer line extension along KY-346, across the floodplain of Spring Creek Tributary #6, in Guthrie, Todd County.**

There shall be no deviation from the plans and specifications submitted and hereby approved unless the proposed change shall first have been submitted to and approved in writing by the Cabinet. This approval is subject to the attached limitations. **Please read these limitations carefully!** If you are unable to adhere to these limitations for any reason, please contact this office prior to construction.

This permit is valid from the standpoint of stream obstruction only. Issuance of this permit does not relieve the permittee from the responsibility of obtaining any other permits or licenses required by this Cabinet and other state, federal and local agencies. Specifically if the project involves work in a stream, such as bank stabilization, dredging, relocation, or in designated wetlands, a 401 Water Quality Certification from the Division of Water will be required.

This permit is nontransferable and is not valid unless actual construction of this authorized work is begun prior to the expiration date noted above. Any violation of the Water Resources Act of 1966 as amended is subject to penalties as set forth in KRS 151.990.

If you have any questions regarding this permit, please call Kourosh Namin at 502-782-7025.

Issued October 1, 2018.

Ron Dutta, P.E., Supervisor
Floodplain Management Section
Surface Water Permit Branch
Division of Water

RD/KN/rd

pc: Madisonville Regional Office
A Scott Marshall – Todd County Floodplain Coordinator
Chris Wilcutt, P.E. McGhee Engineering, Inc.
File



THIS PAGE INTENTIONALLY LEFT BLANK

FINAL CONSTRUCTION REPORT

NAME: City of Guthrie

PERMIT NO: 28232P

AI NO: 4018 Activity ID: APE20180002

Has all work on this project been completed according to the plans and specifications on file with the Division of Water?

Yes: _____

No: _____ **If no, explain. You may include attachments if necessary.**

Mailing Instructions

- Fold the top edge of this page to the top edge of this box.
- Fold the bottom edge of the page up to meet the top fold and tape shut.
- Fill out return address portion
- Affix a stamp and mail.

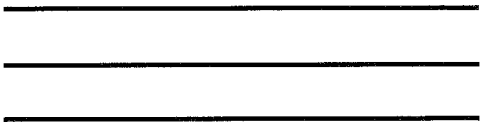

Place
Stamp
Here

**Floodplain Management Section
Division of Water
300 Sower Boulevard
Frankfort, KY 40601**

Stream Construction Permit

Guthrie WWTP

Facility Requirements

Permit Number: 28232P

Activity ID No.:APE20180002

STRC000000002 (AI: 4018 - Sewer) -Subfluvial crossings by 'open cut' method at coordinate 36.654473, -87.174265 in conjunction with approximately 3800 LF of 12-inch sewer line extension along KY-346, across the floodplain of Spring Creek Tributary #6, in Guthrie, Todd County:

Submittal/Action Requirements:

| Condition No. | Condition |
|---------------|--|
| S-1 | City of Guthrie must submit final construction report within 90 days after completion of construction. City of Guthrie must certify in writing that the project has been completed in accordance with the approved plans and specifications. A Final Construction Report Form is enclosed. [401 KAR 4:060 Section 6] |

Narrative Requirements:

| Condition No. | Condition |
|---------------|---|
| T-1 | The issuance of this permit by the cabinet does not convey any property rights of any kind or any exclusive privilege. [KRS 151.250 & 401 KAR 4:060] |
| T-2 | This permit is issued from the standpoint of stream obstruction only and does not constitute certification of any other aspect of the proposed construction. The applicant is liable for any damage resulting from the construction, operation, or maintenance of this project. This permit has been issued under the provisions of KRS Chapter 151.250 and regulations promulgated pursuant thereto. Issuance of this permit does not relieve the permittee from the responsibility of obtaining any other permits or licenses required by this Cabinet and other state, federal and local agencies. [KRS 151.250] |
| T-3 | A copy of this permit must be available at the construction site. [KRS 151.250] |
| T-4 | Any work performed by or for City of Guthrie that does not fully conform to the submitted application or drawings and the limitations set forth in this permit, is subject to partial or total removal and enforcement actions pursuant to KRS 151.280 as directed by the Kentucky Department for Environmental Protection. [KRS 151.280] |
| T-5 | Any design changes or amendments to the approved plans must be submitted to the Division of Water and approved in writing prior to implementation. [KRS 151.250] |
| T-6 | Since Guthrie/ Todd County participates in the National Flood Insurance Program, a local floodplain permit must be obtained prior to beginning of construction. Upon completion of construction City of Guthrie must contact the local permitting agency for final approval of the construction for compliance with the requirements of the local floodplain ordinance. [401 KAR 4:060 Section 9(c)] |
| T-7 | The permittee must obtain a Water Quality Certification (or a determination that none is required) through the Division of Water, Water Quality Branch before beginning construction. Contact the Water Quality Certification Supervisor at (502) 564-3410. [KRS 224.16-050 & Clean Water Act Section 401] |

Stream Construction Permit

Guthrie WWTP

Facility Requirements

Permit Number: 28232P

Activity ID No.: APE20180002

Page 2 of 2

STRC000000002 (AI: 4018 - Sewer) -Subfluvial crossings by 'open cut' method at coordinate 36.654473, -87.174265 in conjunction with approximately 3800 LF of 12-inch sewer line extension along KY-346, across the floodplain of Spring Creek Tributary #6, in Guthrie, Todd County:

Narrative Requirements:

| Condition No. | Condition |
|---------------|--|
| T-8 | Erosion prevention measures, sediment control measures, and other site management practices shall be designed, installed, and maintained in an effective operating condition to prevent migration of sediment off site. [KRS 224.70-110] |
| T-9 | To avoid secondary adverse impacts, all materials used shall be stable and inert, free from pollutants and floatable objects, and shall meet all appropriate engineering standards. (Inert here means materials that are not chemically reactive and that will not rot or decompose, such as soil, rock, broken concrete or similar materials.). [401 KAR 4:060 Section 7] |
| T-10 | Stream bank restoration and stabilization shall be limited to that necessary to restore the stream bank as closely as possible to its original location and configuration, and shall be completed without compromising the conveyance capacity of the stream at any time. [401 KAR 4:060] |
| T-11 | All debris and excess material shall be removed for disposal outside of the base floodplain. [401 KAR 4:060] |
| T-12 | Upon completion of construction all disturbed areas shall be seeded and mulched or otherwise stabilized to prevent erosion. [401 KAR 4:060] |
| T-13 | The entry of mobile equipment into the stream channel shall be limited as much as reasonably possible to minimize degradation of the waters of the Commonwealth. [401 KAR 4:060] |
| T-14 | Construction other than as authorized by this permit shall require written approval from the Division of Water. [401 KAR 4:060] |
| T-15 | The Sub-fluvial crossing must meet the following criteria whichever is applicable: (1) During the construction of the crossing, no material may be placed in the stream or in the flood plain of the stream to form construction pads, coffer dams, access roads, etc., unless prior approval has been obtained from the cabinet. (2) The trench shall be backfilled as closely as possible to the original contour. All excess material from construction of the trench shall be disposed of outside of the flood plain unless the applicant has received prior approval from the cabinet to fill within the flood plain. (3) For subfluvial crossings of erodible channels, there shall be at least thirty (30) inches clear to the top of the pipe or conduit at all points. (4) For subfluvial crossings of nonerodible channels, there shall be at least six (6) inches of clear cover above the top of the pipe or conduit at all points, and the pipe or conduit shall be encased on all sides by at least six (6) inches of concrete. (5) The weight of a pipe and its contents during normal operating conditions at all points must exceed that of an equal volume of water, or the applicant must provide the division with sufficient information to show that the pipe and joints have sufficient strength. [401 KAR 4:050 Section 2] |



DEPARTMENT OF THE ARMY
NASHVILLE DISTRICT, CORPS OF ENGINEERS
Regulatory Division
3701 Bell Road
NASHVILLE, TENNESSEE 37214

SUBJECT: File No. LRN-2018-00737; Proposed Utility Line Crossing on an Unnamed Tributary to Spring Creek, Todd County, Kentucky

City of Guthrie
C/O Mr. Scott Marshall
PO Box 125
Guthrie, Kentucky 42234

Dear Mr. Marshall:

This correspondence is in regard to the pre-construction notification (PCN) for the discharge of dredged or fill material associated with the proposed utility line crossing. The proposed discharge of fill material is a sewer line crossing. The project is located along an Unnamed Tributary to Spring Creek, Todd County, Kentucky (Latitude: 36.6621; Longitude: -87.1708). This project has been assigned number LRN-2018-00737. Please refer to this number in all communication concerning this matter.

Based on the information you provided, Nationwide Permit (NWP) #12 Bank Stabilization Activities, which became effective March 19, 2017 [82 FR 1860], authorizes your proposal as depicted on the enclosed plans. In order for this authorization to be valid, you must ensure the work is performed in accordance with the enclosed *NWP #12 Terms and Conditions*, and the *2017 Nationwide Permit General Conditions*. The work must also comply with the special conditions listed in the enclosed "SPECIAL CONDITIONS FOR PERMIT LRN-2018-00737, City of Guthrie."

This verification is valid until March 18, 2022, unless the NWP authorization is modified, suspended, or revoked prior to that date. Furthermore, if you commence or are under contract to commence this activity before the date of NWP expiration, modification, or revocation, you will have 12 months from the date of expiration, modification or revocation to complete the activity under the present terms and conditions of the NWP. This will apply to all NWPs unless discretionary authority has been exercised on a case-by-case basis to modify, suspend, or revoke the authorization in accordance with 33 CFR 330.4(e) and 33 CFR 330.5(c) or (d).

The NWP 12 verification does not obviate your responsibility to obtain and abide by all other federal, state and local permits or approvals required. The NWP verification should not be considered as an approval of the design features of any activity authorized or an implication that such construction is considered adequate for the purpose intended. In addition, it does not grant any property rights or exclusive privileges and does not authorize any injury to the property or rights of others. Failure to comply with all terms and conditions of this NWP verification invalidates this authorization and could result in a violation of Section 404 of the Clean Water Act and/or Section 10 of the Rivers and Harbors Act.

Upon completing the authorized work, you must fill out and return the enclosed *Certificate of Compliance with Department of the Army Permit* form. Thank you for your cooperation during the permitting process. If you have any questions, please contact me at the above address or telephone (615) 369-7503 or via e-mail mark.carnes@usace.army.mil.

Sincerely,



Floyd M. Carnes
Regulatory Specialist
Regulatory Division

Enclosures

- Enclosure 1 – Special Conditions
- Enclosure 2 – Drawings (Sheets 1-3)
- Enclosure 3 – NWP 12, Terms and Conditions
- Enclosure 4 – 2017 Nationwide Permit General Conditions
- Enclosure 5 – Compliance Certification
- Enclosure 6 – Water Quality Certification

Copy Furnished:

Kentucky Division of Water
Water Quality Certification Section - Electronically

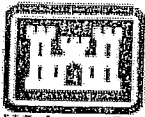

US Army Corps
of Engineers @
Nashville District

SPECIAL CONDITIONS

PERMIT LRN-2018-00737 City of Guthrie

- 1. Permit Drawings:** The Permittee shall construct the authorized activity in accordance with the attached permit drawings (Enclosure 2, Sheets 1-3). Work in waters of the U.S. that deviates from the approved plans shall NOT occur without first obtaining approval from the U.S. Army Corps of Engineer, Nashville District Regulatory Division
- 2. Water Quality Certification:** The Permittee must comply with all conditions of the state permit. The Commonwealth of Kentucky has issued a conditional 401 water quality certification for the NWP. Consequently, the proposed work must also be constructed in accordance with the enclosed 401 certification. The Permittee must comply with all conditions of the state permit.
- 3. Tree Removal:** In accordance with the information provided, no trees would be removed associated with this project. If project plans are modified to include any tree removal, you shall notify this office so we can ensure appropriate ESA coordination with the US Fish and Wildlife Service occurs.

SITE

KENTUCKY
TENNESSEE

TODD CO
MONTGOMERY CO

Guthrie

Warfield
Sch

File No. LRN-2018-00737
Sheet 1 of 3
Enclosure 2



US Army Corps
of Engineers®
Nashville District

2017 Nationwide Permit

82 FR 1860

12. Utility Line Activities.

Activities required for the construction, maintenance, repair, and removal of utility lines and associated facilities in waters of the United States, provided the activity does not result in the loss of greater than 1/2-acre of waters of the United States for each single and complete project.

Utility lines: This NWP authorizes discharges of dredged or fill material into waters of the United States and structures or work in navigable waters for crossings of those waters associated with the construction, maintenance, or repair of utility lines, including outfall and intake structures. There must be no change in pre-construction contours of waters of the United States. A "utility line" is defined as any pipe or pipeline for the transportation of any gaseous, liquid, liquescent, or slurry substance, for any purpose, and any cable, line, or wire for the transmission for any purpose of electrical energy, telephone, and telegraph messages, and internet, radio, and television communication. The term "utility line" does not include activities that drain a water of the United States, such as drainage tile or french drains, but it does apply to pipes conveying drainage from another area.

Material resulting from trench excavation may be temporarily sidecast into waters of the United States for no more than three months, provided the material is not placed in such a manner that it is dispersed by currents or other forces. The district engineer may extend the period of temporary side casting for no more than a total of 180 days, where appropriate. In wetlands, the top 6 to 12 inches of the trench should normally be backfilled with topsoil from the trench. The trench cannot be constructed or backfilled in such a manner as to drain waters of the United States (e.g., backfilling with extensive gravel layers, creating a french drain effect). Any exposed slopes and stream banks must be stabilized immediately upon completion of the utility line crossing of each waterbody.

Utility line substations: This NWP authorizes the construction, maintenance, or expansion of substation facilities associated with a power line or utility line in non-tidal waters of the United States, provided the activity, in combination with all other activities included in one single and complete project, does not result in the loss of greater than 1/2-acre of waters of the United States. This NWP does not authorize discharges into non-tidal wetlands adjacent to tidal waters of the United States to construct, maintain, or expand substation facilities.

Foundations for overhead utility line towers, poles, and anchors: This NWP authorizes the construction or maintenance of foundations for overhead utility line towers, poles, and anchors in all waters of the United States, provided the foundations are the minimum size necessary and separate footings for each tower leg (rather than a larger single pad) are used where feasible.

Access roads: This NWP authorizes the construction of access roads for the construction and maintenance of utility lines, including overhead power lines and utility line substations, in non-tidal waters of the United States, provided the activity, in combination with all other activities included in one single and complete project, does not cause the loss of greater than 1/2-acre of non-tidal waters of the United States. This NWP does not authorize discharges into nontidal wetlands adjacent to tidal waters for access roads. Access roads must be the minimum width necessary (see Note 2, below). Access roads must be constructed so that the length of the

road minimizes any adverse effects on waters of the United States and must be as near as possible to pre-construction contours and elevations (e.g., at grade corduroy roads or geotextile/gravel roads). Access roads constructed above pre-construction contours and elevations in waters of the United States must be properly bridged or culverted to maintain surface flows.

This NWP may authorize utility lines in or affecting navigable waters of the United States even if there is no associated discharge of dredged or fill material (See 33 CFR part 322). Overhead utility lines constructed over section 10 waters and utility lines that are routed in or under section 10 waters without a discharge of dredged or fill material require a section 10 permit.

This NWP authorizes, to the extent that Department of the Army authorization is required, temporary structures, fills, and work necessary for the remediation of inadvertent returns of drilling fluids to waters of the United States through sub-soil fissures or fractures that might occur during horizontal directional drilling activities conducted for the purpose of installing or replacing utility lines. These remediation activities must be done as soon as practicable, to restore the affected waterbody. District engineers may add special conditions to this NWP to require a remediation plan for addressing inadvertent returns of drilling fluids to waters of the United States during horizontal directional drilling activities conducted for the purpose of installing or replacing utility lines.

This NWP also authorizes temporary structures, fills, and work, including the use of temporary mats, necessary to conduct the utility line activity. Appropriate measures must be taken to maintain normal downstream flows and minimize flooding to the maximum extent practicable, when temporary structures, work, and discharges, including cofferdams, are necessary for construction activities, access fills, or dewatering of construction sites. Temporary fills must consist of materials, and be placed in a manner, that will not be eroded by expected high flows. After construction, temporary fills must be removed in their entirety and the affected areas returned to preconstruction elevations. The areas affected by temporary fills must be revegetated, as appropriate.

Notification: The permittee must submit a pre-construction notification to the district engineer prior to commencing the activity if any of the following criteria are met:

- (1) The activity involves mechanized land clearing in a forested wetland for the utility line right-of-way;
- (2) a section 10 permit is required;
- (3) the utility line in waters of the United States, excluding overhead lines, exceeds 500 feet;
- (4) the utility line is placed within a jurisdictional area (i.e., water of the United States), and it runs parallel to or along a stream bed that is within that jurisdictional area;
- (5) discharges that result in the loss of greater than 1/10- acre of waters of the United States;
- (6) permanent access roads are constructed above grade in waters of the United States for a distance of more than 500 feet; or
- (7) permanent access roads are constructed in waters of the United States with impervious materials.
(See general condition 32.)

(Authorities: Sections 10 and 404)

Note 1: Where the utility line is constructed or installed in navigable waters of the United States (i.e., section 10 waters) within the coastal United States, the Great Lakes, and United States territories, a copy of the NWP verification will be sent by the Corps to the National Oceanic and Atmospheric Administration (NOAA), National Ocean Service (NOS), for charting the utility line to protect navigation.

Note 2: For utility line activities crossing a single waterbody more than one time at separate and distant locations, or multiple waterbodies at separate and distant locations, each crossing is considered a single and complete project for purposes of NWP authorization. Utility line activities must comply with 33 CFR 330.6(d).

Note 3: Utility lines consisting of aerial electric power transmission lines crossing navigable waters of the United States (which are defined at 33 CFR part 329) must comply with the applicable minimum clearances specified in 33 CFR 322.5(i).

Note 4: Access roads used for both construction and maintenance may be authorized, provided they meet the terms and conditions of this NWP. Access roads used solely for construction of the utility line must be removed upon completion of the work, in accordance with the requirements for temporary fills.

Note 5: Pipes or pipelines used to transport gaseous, liquid, liquescent, or slurry substances over navigable waters of the United States are considered to be bridges, not utility lines, and may require a permit from the U.S. Coast Guard pursuant to section 9 of the Rivers and Harbors Act of 1899. However, any discharges of dredged or fill material into waters of the United States associated with such pipelines will require a section 404 permit (see NWP 15).

Note 6: This NWP authorizes utility line maintenance and repair activities that do not qualify for the Clean Water Act section 404(f) exemption for maintenance of currently serviceable fills or fill structures.

Note 7: For overhead utility lines authorized by this NWP, a copy of the PCN and NWP verification will be provided to the Department of Defense Siting Clearinghouse, which will evaluate potential effects on military activities.

Note 8: For NWP 12 activities that require pre-construction notification, the PCN must include any other NWP(s), regional general permit(s), or individual permit(s) used or intended to be used to authorize any part of the proposed project or any related activity, including other separate and distant crossings that require Department of the Army authorization but do not require preconstruction notification (see paragraph (b) of general condition 32). The district engineer will evaluate the PCN in accordance with Section D, "District Engineer's Decision." The district engineer may require mitigation to ensure that the authorized activity results in no more than minimal individual and cumulative adverse environmental effects (see general condition 23).

Regional Conditions for the State of Tennessee:

- a. PCN in accordance with NWP General Condition 32 is required for all proposed blasting within waters of the U.S.



US Army Corps
of Engineers ®
Nashville District

2017 Nationwide Permit General Conditions

The following General Conditions must be followed in order for any authorization by NWP to be valid:

State of Tennessee Regional General Conditions (Applicable to ALL Nationwide Permits):

1. A PCN is required for all proposed activities in *Exceptional Tennessee Waters* and/or *Outstanding National Resource Waters*. A list of known *Exceptional Tennessee Waters* and/or *Outstanding National Resource Waters* can be obtained from the Tennessee Department of Environment and Conservation's website: <https://tn.gov/environment/article/wr-water-resources-data-viewer>. A map of known *Exceptional Tennessee Waters* and *Outstanding National Resource Waters* can be obtained from the Tennessee Department of Environment and Conservation's website: <http://tdeconline.tn.gov/dwrf/>.

2. All impacts to wetlands/open waters shall be calculated and reported in acres. Stream impacts shall be calculated separately and reported in both linear feet and acres.

Additional Information

Endangered Species Act: Nationwide Permit General Condition 32, *Pre-Construction Notification*, requires a PCN to be submitted to the District Engineer if any listed species or designated critical habitat might be affected or is in the vicinity of the activity, or if the activity is located in designated resources may be impacted by your proposed project, migratory birds or other natural resources' IPAC website: <http://ecos.fws.gov/ipac>.

Historic Properties: Nationwide Permit General Condition 32, *Pre-Construction Notification*, requires a PCN to be submitted to the District Engineer if the NWP activity might have the potential to cause effects to a historic property listed on, determined to be eligible for listing on, or potentially eligible for listing on, the National Register of Historic Places. The PCN must state which historic property might have the potential to be affected by the proposed activity or include a vicinity map indicating the location of the historic property. Information regarding cultural resources and the National Historic Preservation Act, can be reviewed at the National Park Service's website: <http://www.nps.gov/nrl/>. A map of non-restricted listed properties on the National Register of Historic Places at can be viewed at: <https://www.nps.gov/maps/full.html?mapId=7ad17cc9-b808-4ff8-a2f9-a99909164466>

National General Conditions:

1. Navigation.
 - (a) No activity may cause more than a minimal adverse effect on navigation.
 - (b) Any safety lights and signals prescribed by the U.S. Coast Guard, through regulations or otherwise, must be installed and maintained at the permittee's expense on authorized facilities in navigable waters of the United States.
 - (c) The permittee understands and agrees that, if future operations by the United States require the removal, relocation, or other alteration, of the structure or work herein authorized, or if, in

the opinion of the Secretary of the Army or his authorized representative, said structure or work shall cause unreasonable obstruction to the free navigation of the navigable waters, the permittee will be required, upon due notice from the Corps of Engineers, to remove, relocate, or alter the structural work or obstructions caused thereby, without expense to the United States. No claim shall be made against the United States on account of any such removal or alteration.

2. Aquatic Life Movements. No activity may substantially disrupt the necessary life cycle movements of those species of aquatic life indigenous to the waterbody, including those species that normally migrate through the area, unless the activity's primary purpose is to impound water. All permanent and temporary crossings of waterbodies shall be suitably culverted, bridged, or otherwise designed and constructed to maintain low flows to sustain the movement of those aquatic species. If a bottomless culvert cannot be used, then the crossing should be designed and constructed to minimize adverse effects to aquatic life movements.

3. Spawning Areas. Activities in spawning areas during spawning seasons must be avoided to the maximum extent practicable. Activities that result in the physical destruction (e.g., through excavation, fill, or downstream smothering by substantial turbidity) of an important spawning area are not authorized.

4. Migratory Bird Breeding Areas. Activities in waters of the United States that serve as breeding areas for migratory birds must be avoided to the maximum extent practicable.

5. Shellfish Beds. No activity may occur in areas of concentrated shellfish populations, unless the activity is directly related to a shellfish harvesting activity authorized by NWPs 4 and 48, or is a shellfish seeding or habitat restoration activity authorized by NWP 27.

6. Suitable Material. No activity may use unsuitable material (e.g., trash, debris, car bodies, asphalt, etc.). Material used for construction or discharged must be free from toxic pollutants in toxic amounts (see section 307 of the Clean Water Act).

7. Water Supply Intakes. No activity may occur in the proximity of a public water supply intake, except where the activity is for the repair or improvement of public water supply intake structures or adjacent bank stabilization.

8. Adverse Effects From Impoundments. If the activity creates an impoundment of water, adverse effects to the aquatic system due to accelerating the passage of water, and/or restricting its flow must be minimized to the maximum extent practicable.

Enclosure 4

9. Management of Water Flows. To the maximum extent practicable, the pre-construction course, condition, capacity, and location of open waters must be maintained for each activity, including stream channelization, storm water management activities, and temporary and permanent road crossings, except as provided below. The activity must be constructed to withstand expected high flows. The activity must not restrict or impede the passage of normal or high flows, unless the primary purpose of the activity is to impound water or manage high flows. The activity may alter the pre-construction course, condition, capacity, and location of open waters if it benefits the aquatic environment (e.g., stream restoration or relocation activities).

10. Fills Within 100-Year Floodplains. The activity must comply with applicable FEMA-approved state or local floodplain management requirements.

11. Equipment. Heavy equipment working in wetlands or mudflats must be placed on mats, or other measures must be taken to minimize soil disturbance.

12. Soil Erosion and Sediment Controls. Appropriate soil erosion and sediment controls must be used and maintained in effective operating condition during construction, and all exposed soil and other fills, as well as any work below the ordinary high water mark or high tide line, must be permanently stabilized at the earliest practicable date. Permittees are encouraged to perform work within waters of the United States during periods of low-flow or no-flow, or during low tides.

13. Removal of Temporary Fills. Temporary fills must be removed in their entirety and the affected areas returned to pre-construction elevations. The affected areas must be revegetated, as appropriate.

14. Proper Maintenance. Any authorized structure or fill shall be properly maintained, including maintenance to ensure public safety and compliance with applicable NWP general conditions, as well as any activity-specific conditions added by the district engineer to an NWP authorization.

15. Single and Complete Project. The activity must be a single and complete project. The same NWP cannot be used more than once for the same single and complete project.

16. Wild and Scenic Rivers.

(a) No NWP activity may occur in a component of the National Wild and Scenic River System, or in a river officially designated by Congress as a "study river" for possible inclusion in the system while the river is in an official study status, unless the appropriate Federal agency with direct management responsibility for such river, has determined in writing that the proposed activity will not adversely affect the Wild and Scenic River designation of study status. If a proposed NWP activity will occur in a component of the National Wild and Scenic River System, or in a river officially designated by Congress as a "study river" for possible inclusion in the system while the river is in an official study status, the permittee must submit a pre-construction notification (see general condition 32). The district engineer will coordinate the PCN with the Federal agency with direct management responsibility for that river. The permittee shall not begin the NWP activity until notified by the district engineer that the Federal agency with direct management responsibility for that river has determined in writing that the proposed NWP activity will not adversely affect the Wild and Scenic River designation or study status.

(c) Information on Wild and Scenic Rivers may be obtained from the appropriate Federal land management agency responsible for the designated Wild and Scenic River or study river (e.g.,

National Park Service, U.S. Forest Service, Bureau of Land Management, U.S. Fish and Wildlife Service). Information on these rivers is also available at: <http://www.rivers.gov/>.

17. Tribal Rights. No NWP activity may cause more than minimal adverse effects on tribal rights (including treaty rights), protected tribal resources, or tribal lands.

18. Endangered Species.

(a) No activity is authorized under any NWP which is likely to directly or indirectly jeopardize the continued existence of a threatened or endangered species or a species proposed for such designation, as identified under the Federal Endangered Species Act (ESA), or which will directly or indirectly destroy or adversely modify the critical habitat of such species. No activity is authorized under any NWP which "may affect" a listed species or critical habitat, unless ESA section 7 consultation addressing the effects of the proposed activity has been completed. Direct effects are the immediate effects on listed species and critical habitat caused by the NWP activity. Indirect effects are those effects on listed species and critical habitat caused by the caused by the NWP activity and are later in time, but still are reasonably certain to occur.

(b) Federal agencies should follow their own procedures for complying with the requirements of the ESA. If pre-construction notification is required for the proposed activity, the Federal permittee must provide the district engineer with the appropriate documentation to demonstrate compliance with those requirements. The district engineer will verify that the appropriate documentation has been submitted. If the appropriate documentation has not been submitted, additional ESA section 7 consultation may be necessary for the activity and the respective federal agency would be responsible for fulfilling its obligation under section 7 of the ESA.

(c) Non-federal permittees must submit a pre-construction notification to the district engineer if any listed species or designated critical habitat might be affected or is in the vicinity of the activity, or if the activity is located in designated critical habitat, and shall not begin work on the activity until notified by the district engineer that the requirements of the ESA have been satisfied and that the activity is authorized. For activities that might affect Federally-listed endangered or threatened species or designated critical habitat, the pre-construction notification must include the name(s) of the endangered or threatened species that might be affected by the proposed activity or that utilize the designated critical habitat that might be affected by the proposed activity. The district engineer will determine whether the proposed activity "may affect" or will have "no effect" to listed species and designated critical habitat and will notify the non-Federal applicant of the Corps' determination within 45 days of receipt of a complete pre-construction notification. In cases where the non-Federal applicant has identified listed species or critical habitat that might be affected or is in the vicinity of the activity, and has so notified the Corps, the applicant shall not begin work until the Corps has provided notification that the proposed activity will have "no effect" on listed species or critical habitat, or until ESA section 7 consultation has been completed. If the non-Federal applicant has not heard back from the Corps within 45 days, the applicant must still wait for notification from the Corps.

(d) As a result of formal or informal consultation with the FWS or NMFS the district engineer may add species-specific permit conditions to the NWPs.

(e) Authorization of an activity by an NWP does not authorize the "take" of a threatened or endangered species as defined under the ESA. In the absence of separate authorization (e.g., an ESA Section 10 Permit, a Biological Opinion with "incidental take" provisions, etc.) from the FWS or the NMFS, the Endangered Species Act prohibits any person subject to the jurisdiction of the United States to take a listed species, where "take" means to harass, harm, pursue, hunt, shoot, wound, kill, trap, capture, or collect, or to attempt to engage in any such conduct. The word "harm" in the definition of "take" means an act which actually kills or injures wildlife. Such

an act may include significant habitat modification or degradation where it actually kills or injures wildlife by significantly impairing essential behavioral patterns, including breeding, feeding or sheltering.

(f) If the non-federal permittee has a valid ESA section 10(a)(1)(B) incidental take permit with an approved Habitat Conservation Plan for a project or a group of projects that includes the proposed NWP activity, the non-federal applicant should provide a copy of that ESA section 10(a)(1)(B) permit with the PCN required by paragraph (c) of this general condition. The district engineer will coordinate with the agency that issued the ESA section 10(a)(1)(B) permit to determine whether the proposed NWP activity and the associated incidental take were considered in the internal ESA section 7 consultation conducted for the ESA section 10(a)(1)(B) permit. If that coordination results in concurrence from the agency that the proposed NWP activity and the associated incidental take were considered in the internal ESA section 7 consultation for the ESA section 10(a)(1)(B) permit, the district engineer does not need to conduct a separate ESA section 7 consultation for the proposed NWP activity. The district engineer will notify the non-federal applicant within 45 days of receipt of a complete pre-construction notification whether the ESA section 10(a)(1)(B) permit covers the proposed NWP activity or whether additional ESA section 7 consultation is required.

(g) Information on the location of threatened and endangered species and their critical habitat can be obtained directly from the offices of the FWS and NMFS or their world wide Web pages at <http://www.fws.gov/> or <http://www.fws.gov/ipac> and <http://www.nmfs.noaa.gov/pr/species/esa/> respectively.

19. Migratory Birds and Bald and Golden Eagles. The permittee is responsible for ensuring their action complies with the Migratory Bird Treaty Act and the Bald and Golden Eagle Protection Act. The permittee is responsible for contacting appropriate local office of the U.S. Fish and Wildlife Service to determine applicable measures to reduce impacts to migratory birds or eagles, including whether "incidental take" permits are necessary and available under the Migratory Bird Treaty Act or Bald and Golden Eagle Protection Act for a particular activity.

20. Historic Properties.

(a) In cases where the district engineer determines that the activity may have the potential to cause effects to properties listed, or eligible for listing, in the National Register of Historic Places, the activity is not authorized, until the requirements of Section 106 of the National Historic Preservation Act (NHPA) have been satisfied.

(b) Federal permittees should follow their own procedures for complying with the requirements of section 106 of the National Historic Preservation Act. If pre-construction notification is required for the proposed NWP activity, the Federal permittee must provide the district engineer with the appropriate documentation to demonstrate compliance with those requirements. The district engineer will verify that the appropriate documentation has been submitted. If the appropriate documentation is not submitted, then additional consultation under section 106 may be necessary. The respective federal agency is responsible for fulfilling its obligation to comply with section 106.

(c) Non-federal permittees must submit a pre-construction notification to the district engineer if the NWP activity might have the potential to cause effects to any historic properties listed on, determined to be eligible for listing on, or potentially eligible for listing on the National Register of Historic Places, including previously unidentified properties. For such activities, the pre-construction notification must state which historic properties might have the potential to be affected by the proposed NWP activity or include a vicinity map indicating the location of the historic properties or the potential for the presence of historic properties. Assistance regarding

information on the location of, or potential for, the presence of historic properties can be sought from the State Historic Preservation Officer, Tribal Historic Preservation Officer, or designated tribal representative, as appropriate, and the National Register of Historic Places (see 33 CFR 330.4(g)). When reviewing pre-construction notifications, district engineers will comply with the current procedures for addressing the requirements of section 106 of the National Historic Preservation Act. The district engineer shall make a reasonable and good faith effort to carry out appropriate identification efforts, which may include background research, consultation, oral history interviews, sample field investigation, and field survey. Based on the information submitted in the PCN and these identification efforts, the district engineer shall determine whether the proposed NWP activity has the potential to cause effects on the historic properties. Section 106 consultation is not required when the district engineer determines that the activity does not have the potential to cause effects on historic properties (see 36 CFR 800.3(a)). Section 106 consultation is required when the district engineer determines that the activity has the potential to cause effects on historic properties (see 36 CFR 800.3(a)).

consultation with consulting parties identified under 36 CFR 800.2(c) when he or she makes any of the following effect determinations for the purposes of section 106 of the NHPA: no historic properties affected, no adverse effect, or adverse effect. Where the non-Federal applicant has identified historic properties on which the activity might have the potential to cause effects and so notified the Corps, the non-Federal applicant shall not begin the activity until notified by the district engineer either that the activity has no potential to cause effects to historic properties or that NHPA section 106 consultation has been completed.

(d) For non-federal permittees, the district engineer will notify the prospective permittee within 45 days of receipt of a complete pre-construction notification whether NHPA section 106 consultation is required. If NHPA section 106 consultation is required, the district engineer will notify the non-Federal applicant that he or she cannot begin the activity until section 106 consultation is completed. If the non-Federal applicant has not heard back from the Corps within 45 days, the applicant must still wait for notification from the Corps.

(e) Prospective permittees should be aware that section 110k of the NHPA (54 U.S.C. 306113) prevents the Corps from granting a permit or other assistance to an applicant who, with intent to avoid the requirements of section 106 of the NHPA, has intentionally significantly adversely affected a historic property to which the permit would relate, or having legal power to prevent it, allowed such significant adverse effect to occur, unless the Corps, after consultation with the Advisory Council on Historic Preservation (ACHP), determines that circumstances justify granting such assistance despite the adverse effect created or permitted by the applicant. If circumstances justify granting the assistance, the Corps is required to notify the ACHP and provide documentation specifying the circumstances, the degree of damage to the integrity of any historic properties affected, and proposed mitigation. This documentation must include any views obtained from the applicant, SHPO/THPO, appropriate Indian tribes if the undertaking occurs on or affects historic properties on tribal lands or affects properties of interest to those tribes, and other parties known to have a legitimate interest in the impacts to the permitted activity on historic properties.

21. Discovery of Previously Unknown Remains and Artifacts. If you discover any previously unknown historic, cultural or archeological remains and artifacts while accomplishing the activity authorized by this permit, you must immediately notify the district engineer of what you have found, and to the maximum extent practicable, avoid construction activities that may affect the remains and artifacts until the required coordination has been completed. The district engineer will initiate the Federal, Tribal, and state coordination required to determine if the items or remains warrant a recovery effort or if the site is eligible for listing in the National Register of Historic Places.

22. Designated Critical Resource Waters. Critical resource waters include, NOAA-managed marine sanctuaries and marine monuments, and National Estuarine Research Reserves. The district engineer may designate, after notice and opportunity for public comment, additional waters officially designated by a state as having particular environmental or ecological significance, such as outstanding national resource waters or state natural heritage sites. The district engineer may also designate additional critical resource waters after notice and opportunity for public comment.

- (a) Discharges of dredged or fill material into waters of the United States are not authorized by NWP's 7, 12, 14, 16, 17, 21, 29, 31, 35, 39, 40, 42, 43, 44, 49, 50, 51, and 52 for any activity within, or directly affecting, critical resource waters, including wetlands adjacent to such waters.
- (b) For NWP's 3, 8, 10, 13, 15, 18, 19, 22, 23, 25, 27, 28, 30, 33, 34, 36, 37, 38, and 54, notification is required in accordance with general condition 32, for any activity proposed in the designated critical resource waters including wetlands adjacent to those waters. The district engineer may authorize activities under these NWP's only after it is determined that the impacts to the critical resource waters will be no more than minimal.

23. Mitigation. The district engineer will consider the following factors when determining appropriate and practicable mitigation necessary to ensure that the individual and cumulative adverse environmental effects are no more than minimal:

- (a) The activity must be designed and constructed to avoid and minimize adverse effects, both temporary and permanent, to waters of the United States to the maximum extent practicable at the project site (i.e., on site).
- (b) Mitigation in all its forms (avoiding, minimizing, rectifying, reducing, or compensating for resource losses) will be required to the extent necessary to ensure that the individual and cumulative adverse environmental effects are no more than minimal.
- (c) Compensatory mitigation at a minimum one-for-one ratio will be required for all wetland losses that exceed 1/10-acre and require pre-construction notification, unless the district engineer determines in writing that either some other form of mitigation would be more environmentally appropriate or the adverse environmental effects of the proposed activity are no more than minimal, and provides an activity-specific waiver of this requirement. For wetland losses of 1/10-acre or less that require pre-construction notification, the district engineer may determine on a case-by-case basis that compensatory mitigation is required to ensure that the activity results in only minimal adverse environmental effects.
- (d) For losses of streams or other open waters that require pre-construction notification, the district engineer may require compensatory mitigation to ensure that the activity results in no more than minimal adverse environmental effects. Compensatory mitigation for losses of streams should be provided, if practicable, through stream rehabilitation, enhancement, or preservation, since streams are difficult-to-replace resources (see 33 CFR 332.3(e)(3)).
- (e) Compensatory mitigation plans for NWP activities in or near streams or other open waters will normally include a requirement for the restoration or enhancement, maintenance, and legal protection (e.g., conservation easements) of riparian areas next to open waters. In some cases, the restoration or maintenance/protection of riparian areas may be the only compensatory mitigation required. Restored riparian areas should consist of native species. The width of the required riparian area will address documented water quality or aquatic habitat loss concerns. Normally, the riparian area will be 25 to 50 feet wide on each side of the stream, but the district engineer may require slightly wider riparian areas to address documented water quality or habitat loss concerns. If it is not possible to restore or maintain/protect a riparian area on both

sides of a stream, or if the waterbody is a lake or coastal waters, then restoring or maintaining/protecting a riparian area along a single bank or shoreline may be sufficient. Where both wetlands and open waters exist on the project site, the district engineer will determine the appropriate compensatory mitigation (e.g., riparian areas and/or wetlands compensation) based on what is best for the aquatic environment on a watershed basis. In cases where riparian areas are determined to be the most appropriate form of minimization or compensatory mitigation, the district engineer may waive or reduce the requirement to provide wetland compensatory mitigation for wetland losses.

(f) Compensatory mitigation projects provided to offset losses of aquatic resources must comply with the applicable provisions of 33 CFR part 332.

- (1) The prospective permittee is responsible for proposing an appropriate compensatory mitigation option if compensatory mitigation is necessary to ensure that the activity results in no more than minimal adverse environmental effects. For the NWP's, the preferred mechanism for providing compensatory mitigation is mitigation bank credits or in-lieu fee program credits (see 33 CFR 332.3(b)(2) and (3)). However, if an appropriate number and type of mitigation bank or in-lieu credits are not available at the time the PCN is submitted to the district engineer, the district engineer may approve the use of permittee-responsible mitigation.
- (2) The amount of compensatory mitigation required by the district engineer must be sufficient to ensure that the authorized activity results in no more than minimal individual and cumulative adverse environmental effects (see 33 CFR 330.1(e)(3)). (See also 33 CFR 332.3(f)).
- (3) Since the likelihood of success is greater and the impacts to potentially valuable uplands are reduced, aquatic resource restoration should be the first compensatory mitigation option considered for permittee-responsible mitigation.
- (4) If permittee-responsible mitigation is the proposed option, the prospective permittee is responsible for submitting a mitigation plan. A conceptual or detailed mitigation plan may be used by the district engineer to make the decision on the NWP verification request, but a final mitigation plan that addresses the applicable requirements of 33 CFR 332.4(c)(2) through (14) must be approved by the district engineer before the permittee begins work in waters of the United States, unless the district engineer determines that prior approval of the final mitigation plan is not practicable or not necessary to ensure timely completion of the required compensatory mitigation (see 33 CFR 332.3(k)(3)).
- (5) If mitigation bank or in-lieu fee program credits are the proposed option, the mitigation plan only needs to address the baseline conditions at the impact site and the number of credits to be provided.
- (6) Compensatory mitigation requirements (e.g., resource type and amount to be provided as compensatory mitigation, site protection, ecological performance standards, monitoring requirements) may be addressed through conditions added to the NWP authorization, instead of components of a compensatory mitigation plan (see 33 CFR 332.4(c)(1)(ii)).
- (g) Compensatory mitigation will not be used to increase the acreage losses allowed by the acreage limits of the NWP's. For example, if an NWP has an acreage limit of 1/2-acre, it cannot be used to authorize any NWP activity resulting in the loss of greater than 1/2-acre of waters of the United States, even if compensatory mitigation is provided that replaces or restores some of the lost waters. However, compensatory mitigation can and should be used, as necessary, to ensure that an NWP activity already meeting the established acreage limits also satisfies the no more than minimal impact requirement for the NWP's.
- (h) Permittees may propose the use of mitigation banks, in-lieu fee programs, or permittee-responsible mitigation. When developing a compensatory mitigation proposal, the permittee

must consider appropriate and practicable options consistent with the framework at 33 CFR 332.3(b). For activities resulting in the loss of marine or estuarine resources, permittee-responsible mitigation may be environmentally preferable if there are no mitigation banks or in-lieu fee programs in the area that have marine or estuarine credits available for sale or transfer to the permittee. For permittee-responsible mitigation, the special conditions of the NWP verification must clearly indicate the party or parties responsible for the implementation and performance of the compensatory mitigation project, and, if required, its long-term management.

- (i) Where certain functions and services of waters of the United States are permanently adversely affected by a regulated activity, such as discharges of dredged or fill material into waters of the United States that will convert a forested or scrub-shrub wetland to a herbaceous wetland in a permanently maintained utility line right-of-way, mitigation may be required to reduce the adverse environmental effects of the activity to the no more than minimal level.

24. Safety of Impoundment Structures. To ensure that all impoundment structures are safely designed, the district engineer may require non-Federal applicants to demonstrate that the structures comply with established state dam safety criteria or have been designed by qualified persons. The district engineer may also require documentation that the design has been independently reviewed by similarly qualified persons, and appropriate modifications made to ensure safety.

25. Water Quality. Where States and authorized Tribes, or EPA where applicable, have not previously certified compliance of an NWP with CWA section 401, individual 401 Water Quality Certification must be obtained or waived (see 33 CFR 330.4(c)). The district engineer or State or Tribe may require additional water quality management measures to ensure that the authorized activity does not result in more than minimal degradation of water quality.

26. Coastal Zone Management. In coastal states where an NWP has not previously received a state coastal zone management consistency concurrence, an individual state coastal zone management consistency concurrence must be obtained, or a presumption of concurrence must occur (see 33 CFR 330.4(d)). The district engineer or a State may require additional measures to ensure that the authorized activity is consistent with state coastal zone management requirements.

27. Regional and Case-By-Case Conditions. The activity must comply with any regional conditions that may have been added by the Division Engineer (see 33 CFR 330.4(e)) and with any case specific conditions added by the Corps or by the state, Indian Tribe, or U.S. EPA in its section 401 Water Quality Certification, or by the state in its Coastal Zone Management Act consistency determination.

28. Use of Multiple Nationwide Permits. The use of more than one NWP for a single and complete project is prohibited, except when the acreage loss of waters of the United States authorized by the NWPs does not exceed the acreage limit of the NWP with the highest specified acreage limit. For example, if a road crossing over tidal waters is constructed under NWP 14, with associated bank stabilization authorized by NWP 13, the maximum acreage loss of waters of the United States for the total project cannot exceed 1/3-acre.

29. Transfer of Nationwide Permit Verifications. If the permittee sells the property associated with a nationwide permit verification, the permittee may transfer the nationwide permit verification to the new owner by submitting a letter to the appropriate Corps district office to validate the transfer.

A copy of the nationwide permit verification must be attached to the letter, and the letter must contain the following statement and signature:

When the structures or work authorized by this nationwide permit are still in existence at the time the property is transferred, the terms and conditions of this nationwide permit, including any special conditions, will continue to be binding on the new owner(s) of the property. To validate the transfer of this nationwide permit and the associated liabilities associated with compliance with its terms and conditions, have the transferee sign and date below.

(Transferee)

(Date)

30. Compliance Certification. Each permittee who receives an NWP verification letter from the Corps must provide a signed certification documenting completion of the authorized activity and implementation of any required compensatory mitigation. The success of any required permittee-responsible mitigation, including the achievement of ecological performance standards, will be addressed separately by the district engineer. The Corps will provide the permittee the certification document with the NWP verification letter. The certification document will include:

- (a) A statement that the authorized activity was done in accordance with the NWP authorization, including any general, regional, or activity-specific conditions;
- (b) A statement that the implementation of any required compensatory mitigation was completed in accordance with the permit conditions. If credits from a mitigation bank or in-lieu fee program are used to satisfy the compensatory mitigation requirements, the certification must include the documentation required by 33 CFR 332.3(i)(3) to confirm that the permittee secured the appropriate number and resource type of credits; and
- (c) The signature of the permittee certifying the completion of the activity and mitigation.

The completed certification document must be submitted to the district engineer within 30 days of completion of the authorized activity or the implementation of any required compensatory mitigation, whichever occurs later.

31. Activities Affecting Structures or Works Built by the United States. If an NWP activity also requires permission from the Corps pursuant to 33 U.S.C. 408 because it will alter or temporarily or permanently occupy or use a U.S. Army Corps of Engineers (USACE) federally authorized Civil Works project (a "USACE project"), the prospective permittee must submit a pre-construction notification. See paragraph (b)(10) of general condition 32. An activity that requires section 408 permission is not authorized by NWP until the appropriate Corps office issues the section 408 permission to alter, occupy, or use the USACE project, and the district engineer issues a written NWP verification.

32. Pre-Construction Notification.

- (a) Timing. Where required by the terms of the NWP, the prospective permittee must notify the district engineer by submitting a pre-construction notification (PCN) as early as possible. The

district engineer must determine if the PCN is complete within 30 calendar days of the date of receipt and, if the PCN is determined to be incomplete, notify the prospective permittee within that 30 day period to request the additional information necessary to make the PCN complete. The request must specify the information needed to make the PCN complete. As a general rule, district engineers will request additional information necessary to make the PCN complete. Once the district engineer will request additional information necessary to make the PCN complete only and the district engineer will notify the prospective permittee that the PCN is still incomplete and the PCN review process will not commence until all of the requested information has been received by the district engineer. The prospective permittee shall not begin the activity until either:

- (1) He or she is notified in writing by the district engineer that the activity may proceed under the NWP with any special conditions imposed by the district or division engineer, or and the prospective permittee has not received written notice from the district or division engineer. However, if the permittee was required to notify the Corps pursuant to division condition 18 that listed species or critical habitat might be affected or are in the vicinity of the activity, or to notify the Corps pursuant to general condition 20 that the activity might have the potential to cause effects to historic properties, the permittee cannot begin the activity until receiving written notification from the Corps that there is "no effect" on listed species or "no potential to cause effects" on historic properties, or that any consultation required under Section 7 of the Endangered Species Act (see 33 CFR 330.4(f)) and/or section 106 of the National Historic Preservation Act (see 33 CFR 330.4(g)) has been completed. Also, work cannot begin under NWPs 21, 49, or 50 until the permittee has received written approval from the Corps. If the proposed activity requires a written waiver to exceed specified limits of an NWP, the permittee may not begin the activity until the district engineer issues the waiver. If the district or division engineer notifies the permittee in writing that an individual permit is required within 45 calendar days of receipt of a complete PCN, the permittee cannot begin the activity until an individual permit has been obtained. Subsequently, the permittee's right to proceed under the NWP may be modified, suspended, or revoked only in accordance with the procedure set forth in 33 CFR 330.5(d)(2).

(b) Contents of Pre-Construction Notification: The PCN must be in writing and include the following information:

- (1) Name, address and telephone numbers of the prospective permittee;
- (2) Location of the proposed activity;
- (3) Identify the specific NWP or NWP(s) the prospective permittee wants to use to authorize the proposed activity;
- (4) A description of the proposed activity, the activity's purpose; direct and indirect adverse environmental effects the activity would cause, including the anticipated amount of loss of wetlands, other special aquatic sites, and other waters expected to result from the NWP activity, in acres, linear feet, or other appropriate unit of measure; a description of any proposed mitigation measures intended to reduce the adverse environmental effects caused by the proposed activity; and any other NWP(s), regional general permit(s), or individual permit(s) used or intended to be used to authorize any part of the proposed project or any related activity, including other separate and distant crossings for linear projects that require Department of the Army authorization but do not require pre-construction notification. The description of the proposed activity and any proposed construction notification.

mitigation measures should be sufficiently detailed to allow the district engineer to determine that the adverse environmental effects of the activity will be no more than minimal and to determine the need for compensatory mitigation or other mitigation measures. For single and complete linear projects, the PCN must include the quantity of anticipated losses of wetlands, other special aquatic sites, and other waters for each single and complete crossing of those wetlands, other special aquatic sites, and other waters. Sketches should be provided when necessary to show that the activity complies with the terms of the NWP. (Sketches usually clarify the activity and when provided results in a quicker decision. Sketches should contain sufficient detail to provide an illustrative description of the proposed activity (e.g., a conceptual plan), but do not need to be detailed engineering plans);

- (5) The PCN must include a delineation of wetlands, other special aquatic sites, and other waters, such as lakes and ponds, and perennial, intermittent, and ephemeral streams, on the project site. Wetland delineations must be prepared in accordance with the current method required by the Corps. The permittee may ask the Corps to delineate the special aquatic sites and other waters on the project site, but there may be a delay if the Corps does the delineation, especially if the project site is large or contains many wetlands, other special aquatic sites, and other waters. Furthermore, the 45 day period will not start until the delineation has been submitted to or completed by the Corps, as appropriate. If the proposed activity will result in the loss of greater than 1/10-acre of wetlands and a PCN is required, the prospective permittee must submit a statement describing how the mitigation requirement will be satisfied, or explaining why the adverse environmental effects are no more than minimal and why compensatory mitigation should not be required. As an alternative, the prospective permittee may submit a conceptual or detailed mitigation plan.
- (6) For non-Federal permittees, if any listed species or designated critical habitat might be affected or is in the vicinity of the activity, or if the activity is located in designated critical habitat, the PCN must include the name(s) of those endangered or threatened species that might be affected by the proposed activity or utilize the designated critical habitat that might be affected by the proposed activity. For NWP activities that require pre-construction notification, Federal permittees must provide documentation demonstrating compliance with the Endangered Species Act;
- (7) For non-Federal permittees, if the NWP activity might have the potential to cause effects to a historic property listed on, determined to be eligible for listing on, or potentially eligible for listing on, the National Register of Historic Places, the PCN must state which historic property might have the potential to be affected by the proposed activity or include a vicinity map indicating the location of the historic property. For NWP activities that require pre-construction notification, Federal permittees must provide documentation demonstrating compliance with section 106 of the National Historic Preservation Act; For an activity that will occur in a component of the National Wild and Scenic River System, or in a river officially designated by Congress as a "study river" for possible inclusion in the system while the river is in an official study status, the PCN must identify the Wild and Scenic River or the "study river" (see general condition 16); and
- (8) For an activity that requires permission from the Corps pursuant to 33 U.S.C. 408 because it will alter or temporarily or permanently occupy or use a U.S. Army Corps of Engineers federally authorized civil works project, the pre-construction notification must include a statement confirming that the project proponent has submitted a written request for section 408 permission from the Corps office having jurisdiction over that USACE project.

(c) Form of Pre-Construction Notification: The standard individual permit application form (Form ENG 4345) may be used, but the completed application form must clearly indicate that it is an NWP PCN and must include all of the applicable information required in paragraphs (b)(1) through (10) of this general condition. A letter containing the required information may also be used. Applicants may provide electronic files of PCNs and supporting materials if the district engineer has established tools and procedures for electronic submittals.

(d) Agency Coordination:

- (1) The district engineer will consider any comments from Federal and state agencies concerning the proposed activity's compliance with the terms and conditions of the NWPs and the need for mitigation to reduce the activity's adverse environmental effects so that they are no more than minimal.
- (2) Agency coordination is required for: (i) All NWP activities that require pre-construction notification and result in the loss of greater than 1/2-acre of waters of the United States; (ii) NWP 21, 29, 39, 40, 42, 43, 44, 50, 51, and 52 activities that require pre-construction notification and will result in the loss of greater than 300 linear feet of stream bed; (iii) NWP 13 activities in excess of 500 linear feet, fills greater than one cubic yard per running foot, or involve discharges of dredged or fill material into special aquatic sites; and (iv) NWP 54 activities in excess of 500 linear feet, or that extend into the waterbody more than 30 feet from the mean low water line in tidal waters or the ordinary high water mark in the Great Lakes.
- (3) When agency coordination is required, the district engineer will immediately provide (e.g., via email, facsimile transmission, overnight mail, or other expeditious manner) a copy of the complete PCN to the appropriate Federal or state offices (FWS, state natural resource or water quality agency, EPA, and, if appropriate, the NMFS). With the exception of NWP 37, these agencies will have 10 calendar days from the date the material is transmitted to notify the district engineer via telephone, facsimile transmission, or email that they intend to provide substantive, site-specific comments. The comments must explain why the agency believes the adverse environmental effects will be more than minimal. If so contacted by an agency, the district engineer will wait an additional 15 calendar days before making a decision on the pre-construction notification. The district engineer will fully consider agency comments received within the specified time frame concerning the proposed activity's compliance with the terms and conditions of the NWPs, including the need for mitigation to ensure the net adverse environmental effects of the proposed activity are no more than minimal. The district engineer will provide no response to the resource agency, except as provided below. The district engineer will indicate in the administrative record associated with each pre-construction notification that the resource agencies' concerns were considered. For NWP 37, the emergency watershed protection and rehabilitation activity may proceed immediately in cases where there is an unacceptable hazard to life or a significant loss of property or economic hardship will occur. The district engineer will consider any comments received to decide whether the NWP 37 authorization should be modified, suspended, or revoked in accordance with the procedures at 33 CFR 330.5.
- (4) In cases of where the prospective permittee is not a Federal agency, the district engineer will provide a response to NMFS within 30 calendar days of receipt of any Essential Fish Habitat conservation recommendations, as required by section 305(b)(4)(B) of the Magnuson-Stevens Fishery Conservation and Management Act.

(5) Applicants are encouraged to provide the Corps with either electronic files or multiple copies of pre-construction notifications to expedite agency coordination.

Further Information

1. District Engineers have authority to determine if an activity complies with the terms and conditions of an NWP.
2. NWPs do not obviate the need to obtain other federal, state, or local permits, approvals, or authorizations required by law.
3. NWPs do not grant any property rights or exclusive privileges.
4. NWPs do not authorize any injury to the property or rights of others.
5. NWPs do not authorize interference with any existing or proposed Federal project (see general condition 31).



US Army Corps
of Engineers ®
Nashville District

COMPLIANCE CERTIFICATION

YOU ARE REQUIRED TO SUBMIT THIS SIGNED CERTIFICATION REGARDING THE COMPLETED ACTIVITY AND ANY REQUIRED MITIGATION

I hereby certify that the work authorized by **Permit No. LRN-2018-00737** and any required mitigation was done in accordance with the Corps authorization, including any general, regional, or special conditions.

Permittee Signature

Date

Please note that your permitted activity is subject to a compliance inspection by an U.S. Army Corps of Engineers representative.

Submit this signed certification to the address below:

- U.S Army Corps of Engineers
Regulatory Division
3701 Bell Road
Nashville, TN 37214-266
Attn: Floyd M. Carnes
- East Regulatory Field Office
501 Adesa Parkway
Suite 250
Lenoir City, TN 37771
- West Regulatory Field Office
2042 Beltline Road, Southwest
Building C, Suite 415
Decatur, Al 35601



MATTHEW G. BEVIN
GOVERNOR

CHARLES G. SNAVELY
SECRETARY

ENERGY AND ENVIRONMENT CABINET
DEPARTMENT FOR ENVIRONMENTAL PROTECTION

R. BRUCE SCOTT
COMMISSIONER

300 SOWER BOULEVARD
FRANKFORT, KENTUCKY 40601

**General Certification--Nationwide Permit # 12
Utility Line Backfill and Bedding**

This General Certification is issued March 19, 2017, in conformity with the requirements of Section 401 of the Clean Water Act of 1977, as amended (33 U.S.C. §1341), as well as Kentucky Statute KRS 224.16-050.

For this and all nationwide permits, the definition of surface water is as per 401 KAR 10:001 Chapter 10, Section 1(80): Surface Waters means those waters having well-defined banks and beds, either constantly or intermittently flowing; lakes and impounded waters; marshes and wetlands; and any subterranean waters flowing in well-defined channels and having a demonstrable hydrologic connection with the surface. Lagoons used for waste treatment and effluent ditches that are situated on property owned, leased, or under valid easement by a permitted discharger are not considered to be surface waters of the commonwealth.

Agricultural operations, as defined by KRS 224.71-100(1) conducting activities pursuant to KRS 224.71-100 (3), (4), (5), (6), or 10 are deemed to have certification if they are implementing an Agriculture Water Quality Plan pursuant to KRS 224.71-145.

For all other operations, the Commonwealth of Kentucky hereby certifies under Section 401 of the Clean Water Act (CWA) that it has reasonable assurances that applicable water quality standards under Kentucky Administrative Regulations Title 401, Chapter 10, established pursuant to Sections 301, 302, 304, 306 and 307 of the CWA, will not be violated for the activity covered under NATIONWIDE PERMIT 12, namely Utility Line Backfill and Bedding, provided that the following conditions are met:

1. The activity will not occur within surface waters of the Commonwealth identified by the Kentucky Division of Water as Outstanding State or National Resource Water, Cold Water Aquatic Habitat, or Exceptional Waters.
2. The activity will not occur within surface waters of the Commonwealth identified as perpetually-protected (e.g. deed restriction, conservation easement) mitigation sites.

General Certification--Nationwide Permit # 12
Utility Line Backfill and Bedding
Page 2

3. This general water quality certification is limited to the crossing of surface waters by utility lines. This document does not authorize the installation of utility lines in a linear manner within the stream channel or below the top of the stream bank.
4. For a single crossing, impacts from the construction and maintenance corridor in surface waters shall not exceed 50 feet of bank disturbance.
5. This general certification shall not apply to projects where multiple nationwide permits are issued for individual crossings which are part of a single, larger utility line project where the cumulative impacts exceed ½ acre of wetlands or 300 linear feet of surface waters. Cumulative impacts include utility line crossings, permanent or temporary access roads, headwalls, associated bank stabilization areas, substations, pole or tower foundations, maintenance corridor, and staging areas.
6. Stream impacts under Conditions 4 and 5 of this certification are defined as the length of bank disturbed. For utility line crossings and roads, only one bank length is used in calculation of the totals.
7. Any crossings must be constructed in a manner that does not impede natural water flow.
8. Stream impacts covered under this General Water Quality Certification and undertaken by those persons defined as an agricultural operation under the Agricultural Water Quality Act must be completed in compliance with the Kentucky Agricultural Water Quality Plan (KWQP).
9. The Kentucky Division of Water may require submission of a formal application for an individual certification for any project if the project has been determined to likely have a significant adverse effect upon water quality or degrade the waters of the Commonwealth so that existing uses of the water body or downstream waters are precluded.
10. Activities that do not meet the conditions of this General Water Quality Certification require an Individual Section 401 Water Quality Certification.
11. Blasting of stream channels, even under dry conditions, is not allowed under this general water quality certification.
12. Utility lines placed parallel to the stream shall be located at least 50 feet from an intermittent or perennial stream, measured from the top of the stream bank. The cabinet may allow construction within the 50 foot buffer if avoidance and minimization efforts are shown and adequate methods are utilized to prevent soil from entering the stream.

13. Utility line stream crossings shall be constructed by methods that maintain flow and allow for a dry excavation. Water pumped from the excavation shall be contained and allowed to settle prior to re-entering the stream. Excavation equipment and vehicles shall operate outside of the flowing portion of the stream. Spoil material from the excavation shall not be allowed to enter the flowing portion of the stream.
14. The activities shall not result in any permanent changes in pre-construction elevation contours in surface waters or wetlands or stream dimension, pattern or profile.
15. Utility line activities which impact wetlands shall not result in conversion of the area to non-wetland status. Mechanized land clearing of forested wetlands for the installation or maintenance of utility lines is not authorized under this certification.
16. Activities qualifying for coverage under this General Water Quality Certification are subject to the following conditions:
 - Projects requiring in-stream stormwater detention/retention basins shall require individual water quality certifications.
 - Erosion and sedimentation pollution control plans and Best Management Practices must be designed, installed, and maintained in effective operating condition at all times during construction activities so that violations of state water quality standards do not occur.
 - Sediment and erosion control measures, such as check-dams constructed of any material, silt fencing, hay bales, etc., shall not be placed within surface waters of the Commonwealth, either temporarily or permanently, without prior approval by the Kentucky Division of Water's Water Quality Certification Section. If placement of sediment and erosion control measures in surface waters is unavoidable, design and placement of temporary erosion control measures shall not be conducted in such a manner that may result in instability of streams that are adjacent to, upstream, or downstream of the structures. All sediment and erosion control devices shall be removed and the natural grade restored within the completion timeline of the activities.
 - Measures shall be taken to prevent or control spills of fuels, lubricants, or other toxic materials used in construction from entering the watercourse.
 - Removal of riparian vegetation shall be limited to that necessary for equipment access.
 - To the maximum extent practicable, all in-stream work under this certification shall be performed under low-flow conditions.
 - Heavy equipment, e.g. bulldozers, backhoes, draglines, etc., if required for this project, should not be used or operated within the stream channel. In those instances in which such in-stream work is unavoidable, then it shall

General Certification--Nationwide Permit # 12
Utility Line Backfill and Bedding
Page 4

be performed in such a manner and duration as to minimize turbidity and disturbance to substrates and bank or riparian vegetation.

- Any fill shall be of such composition that it will not adversely affect the biological, chemical, or physical properties of the receiving waters and/or cause violations of water quality standards. If rip-rap is utilized, it should be of such weight and size that bank stress or slump conditions will not be created because of its placement.
- If there are water supply intakes located downstream that may be affected by increased turbidity and suspended solids, the permittee shall notify the operator when such work will be done.
- Should evidence of stream pollution or jurisdictional wetland impairment and/or violations of water quality standards occur as a result of this activity (either from a spill or other forms of water pollution), the Kentucky Division of Water shall be notified immediately by calling (800) 928-2380.

Non-compliance with the conditions of this general certification or violation of Kentucky state water quality standards may result in civil penalties.

WATER QUALITY GENERAL CERTIFICATION
OF UTILITY LINE ACTIVITIES ALONG STREAMS
IN EFFECT: MARCH 19, 2017

Condition 12 of the March 19, 2017 Section 401 Water Quality Certification (WQC) of the U.S. Army Corps of Engineers' Nationwide Permit (NWP) # 12 Utility Line Backfill and Bedding states:

Utility lines placed parallel to the stream shall be located at least 50 feet from an intermittent or perennial stream, measured from the top of the stream bank. The cabinet may allow for construction within the 50-ft buffer if avoidance and minimization efforts are shown and adequate methods are utilized to prevent soil from entering the stream.

If a utility line project qualifies for a general certification of NWP 12 and is within 50 feet of the stream bank, a WQC application and a site-specific sediment and erosion control plan must be submitted for review by WQC before construction and construction-related activities can proceed. This is in addition to the Stormwater Pollution Prevention Plans for construction sites one (1) acre or more in size. Approval of the sediment and erosion control plan by the WQC Section is required before construction activities can begin.

WHY SEDIMENT AND EROSION CONTROL PLANS AND PRACTICES?

Construction activities near streams, rivers, and lakes have the potential to cause water pollution and stream degradation if erosion and sediment controls are not properly installed and maintained. In order to effectively reduce erosion and sedimentation impacts, plans and practices must be designed, located, installed, and maintained in effective operating condition at all times during land disturbing activities to prevent the discharge of sediment and other pollutants into waters of the Commonwealth. Sediment is a major contributor to the pollution of surface waters in Kentucky and construction activities are a major source of sediment and stream siltation. Disturbed soil, if not managed properly, can be washed off-site during storms and can cause major impairment in the receiving waters. Excessive silt causes adverse impacts such as disruption of aquatic organism life cycles, reduced passage, higher drinking water treatment costs for sediment removal, and the alteration of waters' physical/chemical properties, resulting in degradation of its quality. Therefore, erosion prevention and sediment control practices are the key parameter for successful water quality protection.

Applicants should design the site construction and development by selecting erosion prevention and sediment controls and practices to accommodate the unique hydrologic and geologic conditions of the site. Some of the factors to be considered include: local development requirements and/or codes, precipitation patterns for the area when the project will be underway, soil types, slopes, layout of structures for the site, sensitivity of nearby waters and natural areas, and safety concerns. A number of structural practices (e.g., mulching, vegetated buffer strips, grassed swales, retention/detention ponds, silt fence and hay bale barriers, stone check dams, inlet protection, infiltration practices) and non-structural practices (minimizing disturbance, good housekeeping) have shown to be efficient, cost effective, and versatile for construction site developers to implement.

EROSION PREVENTION AND SEDIMENT CONTROL STRATEGIES

Appropriate erosion prevention and sediment control measures and other stormwater management practices must be designed, installed, and maintained. Applicants are encouraged to perform work within

surface waters during periods of low-flow or no-flow. To ensure that all sources of soil erosion and sediment on the construction site are adequately controlled, the following strategies should be employed:

- Sediment and erosion control measures shall not be placed in surface waters. The design and placement of temporary erosion control measures shall not be conducted in a manner that may result in disruption of flow in wetlands or streams.
- Maximize the protection of existing vegetation. Natural vegetation should be retained, protected or supplemented to the maximum extent practical, and vegetation not intended for removal should be adequately marked, fenced, or flagged as necessary.
- Avoid disturbing critical areas. Areas such as sinkholes, streams, wetlands, stream buffers, highly erodible soils, and steep slopes should be avoided to the greatest extent feasible. Mark, fence or flag areas in the field that should be protected from construction activities such as clearing, grubbing, grading, mowing, staging activities, material storage and/or other related activities.
- Minimize size and duration of disturbed soil. Limit site preparation of activities such as grading and clearing to where they are absolutely necessary and consistent with plan and daily schedules of construction activities.
- Manage stormwater. Prevent stormwater from entering areas and leaving areas of disturbed soil by using vegetated strips, diversion dikes and swales, filter berms, sediment traps and basins, check dams, stabilized construction entrances, and silt fences or filter tubes/wattles. Reduce the amount of sediment and water velocity produced from areas of disturbed soils by using vegetation, riprap, sod, seeding and mulching or blankets, as well as the use of structural measures including diversion, check dams, slope drains, and storm drain protection.
- Stabilize soils. Stabilize soil with seeding and mulch as soon as possible after disturbance. Soil disturbed by construction activities should be stabilized within 14 days of ceasing construction activities. Erosion prevention measures such as erosion control mats/blankets, mulch, hydro applications, tracking, or soil binders shall be implemented on disturbed areas within 24 hours or as soon as practical after completion of disturbance/grading or following the end of activities. Final stabilization practices shall be initiated on any site where construction activities have been suspended for more than 180 days.
- Use low-impact/biological/recyclable materials. To the extent possible, construction managers should utilize natural or recyclable materials as temporary measures than can remain on-site after the completion of construction. One example is using mulch berms as opposed to silt fences, which must be removed and disposed after the completion of construction activities has occurred and vegetation has become well-established. This also reduces waste and removal costs.

SEDIMENT AND EROSION CONTROL PLAN REQUIREMENTS

Erosion prevention and sediment control plans submitted to WQC must contain detailed drawings, a site description and supporting information (narrative), including the following:

1. Narrative discussion of why the utility line must be placed within 50 feet of the top of the stream bank;
2. Construction details with dimensions, cross-sectional views and plan views to scale, showing location of utility lines and all surface waters;
3. Site development plan with the proposed construction area and construction-related activities areas clearly outlined, estimated project start and end dates, project type and description of all construction activities at the site;

4. The location of all surface waters on a 7.5 Minute topographical map, including streams, wetlands, sinkholes, and stormwater discharges from the site;
5. The types, depth, slope, locations and limitations of the soils and geology, natural landscape features, drainage patterns, flooding potential, and other pertinent information that helps identify both beneficial conditions and potential problems of a site;
6. Locations of temporary and permanent erosion, sediment, and stormwater management structures; construction details with dimensions, cross-sectional views and/or plan views with enough information for the reviewer and contractor to understand how to install the practice;
7. Approximate slopes anticipated after major grading activities;
8. Areas of soil disturbance, including an outline of areas which are not to be disturbed;
9. Location and technical specifications of any bank stabilization;
10. Location and boundaries of buffer zones, if any, existing or established to protect waters of the Commonwealth located within the boundaries of the project;
11. Locations of stockpile and/or borrow areas;
12. Separate sheets for staged plans to show detail, including the clearing and grubbing phase, initial grading plan with perimeter control and the final grading plan with final erosion prevention and sediment control plans and stormwater management controls in place.

Approved plans and specifications for projects are incorporated by reference and are enforceable parts of a certification. Any changes to the approved plans or specifications require written approval by WQC. For questions or clarifications, contact the Water Quality Certification Section at (502) 564-3410

REFERENCES

Kentucky Pollutant Discharge Elimination System (KPDES) General Permit for Stormwater Discharge Associated with Construction Activities (KYR10). Locate on line at:
<http://water.ky.gov/permitting/Pages/WastewaterDischarge.aspx>

Best Management Practices (BMPs) for Controlling Erosion, Sediment, and Pollutant Runoff from Construction Sites. Planning and Technical Specifications Manual for Stormwater Pollution Prevention Plans. Revised October 2009. Technology Transfer Program, Kentucky Transportation Center, University of Kentucky.

General Certification of Nationwide Permit #12, Utility Line Backfill and Bedding, 2017. Locate on line at: <http://water.ky.gov/permitting/Pages/CertificationNationwidePermits.aspx>



DEPARTMENT OF THE ARMY
NASHVILLE DISTRICT, CORPS OF ENGINEERS
Regulatory Division
3701 Bell Road
NASHVILLE, TENNESSEE 37214

SUBJECT: File No. LRN-2018-00736; Proposed Utility Line Crossing on Spring Creek, Todd County, Kentucky

City of Guthrie
C/O Mr. Scott Marshall
PO Box 125
Guthrie, Kentucky 42234

Dear Mr. Marshall:

This correspondence is in regard to the pre-construction notification (PCN) for the discharge of dredged or fill material associated with the proposed utility line crossing. The proposed discharge of fill material is a sewer line crossing. The project is located along Spring Creek, Todd County, Kentucky (Latitude: 36.6546; Longitude: -87.1741). This project has been assigned number LRN-2018-00736. Please refer to this number in all communication concerning this matter.

Based on the information you provided, Nationwide Permit (NWP) #12 Bank Stabilization Activities, which became effective March 19, 2017 [82 FR 1860], authorizes your proposal as depicted on the enclosed plans. In order for this authorization to be valid, you must ensure the work is performed in accordance with the enclosed *NWP #12 Terms and Conditions*, and the *2017 Nationwide Permit General Conditions*. The work must also comply with the special conditions listed in the enclosed "SPECIAL CONDITIONS FOR PERMIT LRN-2018-00736, City of Guthrie."

This verification is valid until March 18, 2022, unless the NWP authorization is modified, suspended, or revoked prior to that date. Furthermore, if you commence or are under contract to commence this activity before the date of NWP expiration, modification, or revocation, you will have 12 months from the date of expiration, modification or revocation to complete the activity under the present terms and conditions of the NWP. This will apply to all NWPs unless discretionary authority has been exercised on a case-by-case basis to modify, suspend, or revoke the authorization in accordance with 33 CFR 330.4(e) and 33 CFR 330.5(c) or (d).

The NWP 12 verification does not obviate your responsibility to obtain and abide by all other federal, state and local permits or approvals required. The NWP verification should not be considered as an approval of the design features of any activity authorized or an implication that such construction is considered adequate for the purpose intended. In addition, it does not grant any property rights or exclusive privileges and does not authorize any injury to the property or rights of others. Failure to comply with all terms and conditions of this NWP verification invalidates this authorization and could result in a violation of Section 404 of the Clean Water Act and/or Section 10 of the Rivers and Harbors Act.

Upon completing the authorized work, you must fill out and return the enclosed *Certificate of Compliance with Department of the Army Permit* form. Thank you for your cooperation during the permitting process. If you have any questions, please contact me at the above address or telephone (615) 369-7503 or via e-mail mark.carnes@usace.army.mil.

Sincerely,



Floyd M. Carnes
Regulatory Specialist
Regulatory Division

Enclosures

- Enclosure 1 – Special Conditions
- Enclosure 2 – Drawings (Sheets 1-3)
- Enclosure 3 – NWP 12, Terms and Conditions
- Enclosure 4 – 2017 Nationwide Permit General Conditions
- Enclosure 5 – Compliance Certification
- Enclosure 6 – Water Quality Certification

Copy Furnished:

Kentucky Division of Water
Water Quality Certification Section - Electronically



US Army Corps
of Engineers @
Nashville District

SPECIAL CONDITIONS

PERMIT LRN-2018-00736 City of Guthrie

- 1. Permit Drawings:** The Permittee shall construct the authorized activity in accordance with the attached permit drawings (Enclosure 2, Sheets 1-3). Work in waters of the U.S. that deviates from the approved plans shall NOT occur without first obtaining approval from the U.S. Army Corps of Engineer, Nashville District Regulatory Division
- 2. Water Quality Certification:** The Permittee must comply with all conditions of the state permit. The Commonwealth of Kentucky has issued a conditional 401 water quality certification for the NWP. Consequently, the proposed work must also be constructed in accordance with the enclosed 401 certification. The Permittee must comply with all conditions of the state permit.
- 3. Tree Removal:** In accordance with the information provided, no trees would be removed associated with this project. If project plans are modified to include any tree removal, you shall notify this office so we can ensure appropriate ESA coordination with the US Fish and Wildlife Service occurs.

SITE

KENTUCKY
TENNESSEE

WIND CO
MONTGOMERY CO

Guthrie

Warfield
Sch

Hollins
Chapel

File No. LRN-2018-00736
Sheet 1 of 3
Enclosure 2

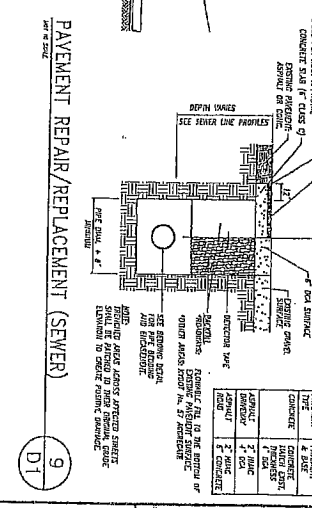
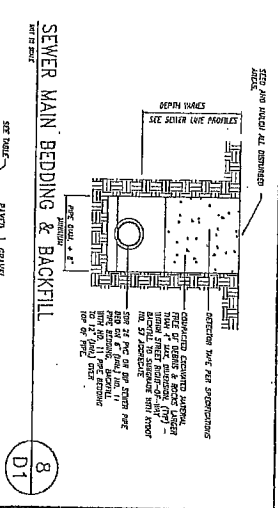
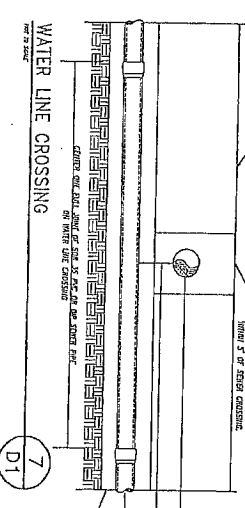
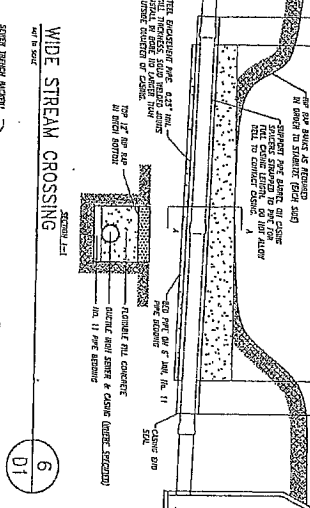
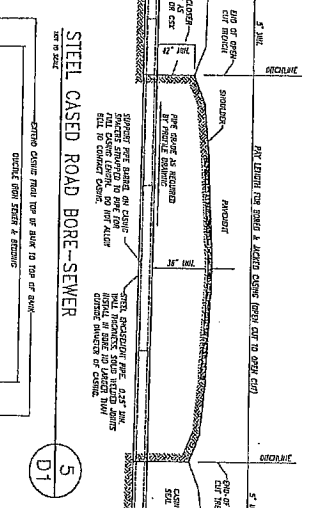
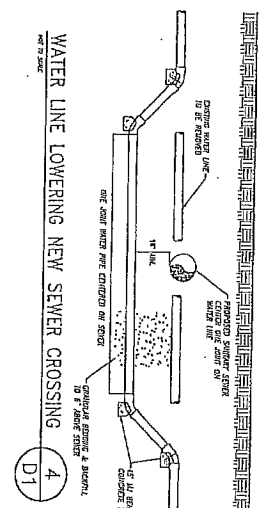
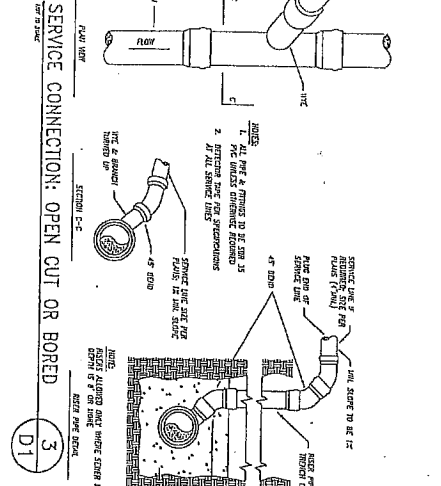
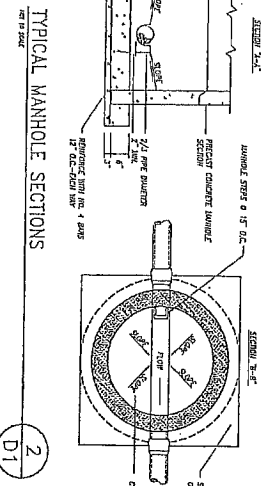
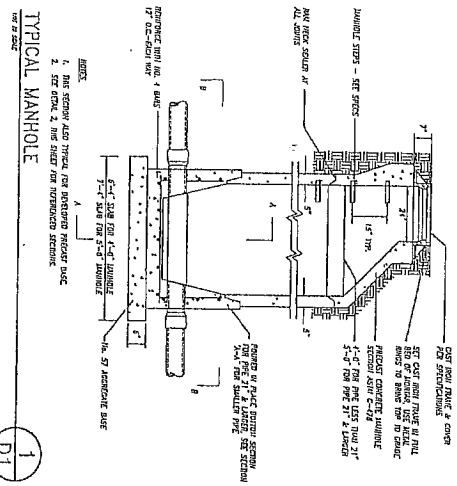

File No. LRN-2018-00736
 Sheet 2 of 3
 Enclosure 2

| | | | | |
|---|--|--|---|--|
| <p>McSHEE 202 Siding Street Guthrie, KY 42344 (270) 402-9885</p> | <p>City of Guthrie, Kentucky NOVELIS SANITARY SEWER EXTENSION PROJECT</p> <p>Contract 1 - Sewer Line Extension Standard Gravity Sewer Details</p> | <p>FIRM: McShee Engineering DES BY: CWM CHK BY: MWM DWN BY: CWM APP BY: MWM SCALE: AS SHOWN PROJECT DATE: 2018 PRINTED:</p> <p>LENGTH OF BAR IS 1" ON ORIGINAL DRAWING</p> | <p>NO.</p> <p>REVISIONS</p> <p>DATE</p> | <p>August 16, 2018</p> <p>City of Guthrie, Kentucky</p> <p>City Engineer</p> <p>City Clerk</p> |
| | | | <p>SHEET 01</p> | <p>City of Guthrie, Kentucky</p> <p>City Engineer</p> <p>City Clerk</p> |



US Army Corps
of Engineers®
Nashville District

2017 Nationwide Permit

82 FR 1860

12. Utility Line Activities.

Activities required for the construction, maintenance, repair, and removal of utility lines and associated facilities in waters of the United States, provided the activity does not result in the loss of greater than 1/2-acre of waters of the United States for each single and complete project.

Utility lines: This NWP authorizes discharges of dredged or fill material into waters of the United States and structures or work in navigable waters for crossings of those waters associated with the construction, maintenance, or repair of utility lines, including outfall and intake structures. There must be no change in pre-construction contours of waters of the United States. A "utility line" is defined as any pipe or pipeline for the transportation of any gaseous, liquid, liquescent, or slurry substance, for any purpose, and any cable, line, or wire for the transmission for any purpose of electrical energy, telephone, and telegraph messages, and internet, radio, and television communication. The term "utility line" does not include activities that drain a water of the United States, such as drainage tile or french drains, but it does apply to pipes conveying drainage from another area.

Material resulting from trench excavation may be temporarily sidecast into waters of the United States for no more than three months, provided the material is not placed in such a manner that it is dispersed by currents or other forces. The district engineer may extend the period of temporary side casting for no more than a total of 180 days, where appropriate. In wetlands, the top 6 to 12 inches of the trench should normally be backfilled with topsoil from the trench. The trench cannot be constructed or backfilled in such a manner as to drain waters of the United States (*e.g.*, backfilling with extensive gravel layers, creating a french drain effect). Any exposed slopes and stream banks must be stabilized immediately upon completion of the utility line crossing of each waterbody.

Utility line substations: This NWP authorizes the construction, maintenance, or expansion of substation facilities associated with a power line or utility line in non-tidal waters of the United States, provided the activity, in combination with all other activities included in one single and complete project, does not result in the loss of greater than 1/2-acre of waters of the United States. This NWP does not authorize discharges into non-tidal wetlands adjacent to tidal waters of the United States to construct, maintain, or expand substation facilities.

Foundations for overhead utility line towers, poles, and anchors: This NWP authorizes the construction or maintenance of foundations for overhead utility line towers, poles, and anchors in all waters of the United States, provided the foundations are the minimum size necessary and separate footings for each tower leg (rather than a larger single pad) are used where feasible.

Access roads: This NWP authorizes the construction of access roads for the construction and maintenance of utility lines, including overhead power lines and utility line substations, in non-tidal waters of the United States, provided the activity, in combination with all other activities included in one single and complete project, does not cause the loss of greater than 1/2-acre of non-tidal waters of the United States. This NWP does not authorize discharges into nontidal wetlands adjacent to tidal waters for access roads. Access roads must be the minimum width necessary (see Note 2, below). Access roads must be constructed so that the length of the

road minimizes any adverse effects on waters of the United States and must be as near as possible to pre-construction contours and elevations (e.g., at grade corduroy roads or geotextile/gravel roads). Access roads constructed above pre-construction contours and elevations in waters of the United States must be properly bridged or culverted to maintain surface flows.

This NWP may authorize utility lines in or affecting navigable waters of the United States even if there is no associated discharge of dredged or fill material (See 33 CFR part 322). Overhead utility lines constructed over section 10 waters and utility lines that are routed in or under section 10 waters without a discharge of dredged or fill material require a section 10 permit.

This NWP authorizes, to the extent that Department of the Army authorization is required, temporary structures, fills, and work necessary for the remediation of inadvertent returns of drilling fluids to waters of the United States through sub-soil fissures or fractures that might occur during horizontal directional drilling activities conducted for the purpose of installing or replacing utility lines. These remediation activities must be done as soon as practicable, to restore the affected waterbody. District engineers may add special conditions to this NWP to require a remediation plan for addressing inadvertent returns of drilling fluids to waters of the United States during horizontal directional drilling activities conducted for the purpose of installing or replacing utility lines.

This NWP also authorizes temporary structures, fills, and work, including the use of temporary mats, necessary to conduct the utility line activity. Appropriate measures must be taken to maintain normal downstream flows and minimize flooding to the maximum extent practicable, when temporary structures, work, and discharges, including cofferdams, are necessary for construction activities, access fills, or dewatering of construction sites. Temporary fills must consist of materials, and be placed in a manner, that will not be eroded by expected high flows. After construction, temporary fills must be removed in their entirety and the affected areas returned to preconstruction elevations. The areas affected by temporary fills must be revegetated, as appropriate.

Notification: The permittee must submit a pre-construction notification to the district engineer prior to commencing the activity if any of the following criteria are met:

- (1) The activity involves mechanized land clearing in a forested wetland for the utility line right-of-way;
 - (2) a section 10 permit is required;
 - (3) the utility line in waters of the United States, excluding overhead lines, exceeds 500 feet;
 - (4) the utility line is placed within a jurisdictional area (i.e., water of the United States), and it runs parallel to or along a stream bed that is within that jurisdictional area;
 - (5) discharges that result in the loss of greater than 1/10- acre of waters of the United States;
 - (6) permanent access roads are constructed above grade in waters of the United States for a distance of more than 500 feet; or
 - (7) permanent access roads are constructed in waters of the United States with impervious materials.
- (See general condition 32.)

(Authorities: Sections 10 and 404)

Note 1: Where the utility line is constructed or installed in navigable waters of the United States (i.e., section 10 waters) within the coastal United States, the Great Lakes, and United States territories, a copy of the NWP verification will be sent by the Corps to the National Oceanic and Atmospheric Administration (NOAA), National Ocean Service (NOS), for charting the utility line to protect navigation.

Note 2: For utility line activities crossing a single waterbody more than one time at separate and distant locations, or multiple waterbodies at separate and distant locations, each crossing is considered a single and complete project for purposes of NWP authorization. Utility line activities must comply with 33 CFR 330.6(d).

Note 3: Utility lines consisting of aerial electric power transmission lines crossing navigable waters of the United States (which are defined at 33 CFR part 329) must comply with the applicable minimum clearances specified in 33 CFR 322.5(i).

Note 4: Access roads used for both construction and maintenance may be authorized, provided they meet the terms and conditions of this NWP. Access roads used solely for construction of the utility line must be removed upon completion of the work, in accordance with the requirements for temporary fills.

Note 5: Pipes or pipelines used to transport gaseous, liquid, liquescent, or slurry substances over navigable waters of the United States are considered to be bridges, not utility lines, and may require a permit from the U.S. Coast Guard pursuant to section 9 of the Rivers and Harbors Act of 1899. However, any discharges of dredged or fill material into waters of the United States associated with such pipelines will require a section 404 permit (see NWP 15).

Note 6: This NWP authorizes utility line maintenance and repair activities that do not qualify for the Clean Water Act section 404(f) exemption for maintenance of currently serviceable fills or fill structures.

Note 7: For overhead utility lines authorized by this NWP, a copy of the PCN and NWP verification will be provided to the Department of Defense Siting Clearinghouse, which will evaluate potential effects on military activities.

Note 8: For NWP 12 activities that require pre-construction notification, the PCN must include any other NWP(s), regional general permit(s), or individual permit(s) used or intended to be used to authorize any part of the proposed project or any related activity, including other separate and distant crossings that require Department of the Army authorization but do not require preconstruction notification (see paragraph (b) of general condition 32). The district engineer will evaluate the PCN in accordance with Section D, "District Engineer's Decision." The district engineer may require mitigation to ensure that the authorized activity results in no more than minimal individual and cumulative adverse environmental effects (see general condition 23).

Regional Conditions for the State of Tennessee:

- a. PCN in accordance with NWP General Condition 32 is required for all proposed blasting within waters of the U.S.



US Army Corps
of Engineers®
Nashville District

2017 Nationwide Permit General Conditions

The following General Conditions must be followed in order for any authorization by NWP to be valid:

State of Tennessee Regional General Conditions (Applicable to ALL Nationwide Permits):

1. A PCN is required for all proposed activities in *Exceptional Tennessee Waters* and/or *Outstanding National Resource Waters*. A list of known *Exceptional Tennessee Waters* and/or *Outstanding National Resource Waters* can be obtained from the Tennessee Department of Environment and Conservation's website: <https://tn.gov/environment/article/wr-water-resources-data-viewer>. A map of known *Exceptional Tennessee Waters* and *Outstanding National Resource Waters* can be obtained from the Tennessee Department of Environment and Conservation's website: <http://tdeconline.tn.gov/dwr/>.
2. All impacts to wetlands/open waters shall be calculated and reported in acres. Stream impacts shall be calculated separately and reported in both linear feet and acres.

Additional Information

Endangered Species Act: Nationwide Permit General Condition 32, *Pre-Construction Notification*, requires a PCN to be submitted to the District Engineer if any listed species or designated critical habitat might be affected or is in the vicinity of the activity, or if the activity is located in designated critical habitat. To determine if any listed species, critical habitat, migratory birds or other natural resources may be impacted by your proposed project, please consult the U.S. Fish and Wildlife Services' IPAC website: <http://ecos.fws.gov/ipac>.

Historic Properties: Nationwide Permit General Condition 32, *Pre-Construction Notification*, requires a PCN to be submitted to the District Engineer if the NWP activity might have the potential to cause effects to a historic property listed on, determined to be eligible for listing on, or potentially eligible for listing on, the National Register of Historic Places. The PCN must state which historic property might have the potential to be affected by the proposed activity or include a vicinity map indicating the location of the historic property. Information regarding cultural resources and the National Historic Preservation Act, can be reviewed at the National Park Service's website: <http://www.nps.gov/nr/>. A map of non-restricted listed properties on the National Register of Historic Places at can be viewed at: <https://www.nps.gov/maps/tul.html?mapId=7ad17cc9-b808-4ff8-a2f9-a99909164466>

National General Conditions:

1. Navigation.

- (a) No activity may cause more than a minimal adverse effect on navigation.
- (b) Any safety lights and signals prescribed by the U.S. Coast Guard, through regulations or otherwise, must be installed and maintained at the permittee's expense on authorized facilities in navigable waters of the United States.
- (c) The permittee understands and agrees that, if future operations by the United States require the removal, relocation, or other alteration, of the structure or work herein authorized, or if, in

the opinion of the Secretary of the Army or his authorized representative, said structure or work shall cause unreasonable obstruction to the free navigation of the navigable waters, the permittee will be required, upon due notice from the Corps of Engineers, to remove, relocate, or alter the structural work or obstructions caused thereby, without expense to the United States. No claim shall be made against the United States on account of any such removal or alteration.

2. Aquatic Life Movements. No activity may substantially disrupt the necessary life cycle movements of those species of aquatic life indigenous to the waterbody, including those species that normally migrate through the area, unless the activity's primary purpose is to impound water. All permanent and temporary crossings of waterbodies shall be suitably culverted, bridged, or otherwise designed and constructed to maintain low flows to sustain the movement of those aquatic species. If a bottomless culvert cannot be used, then the crossing should be designed and constructed to minimize adverse effects to aquatic life movements.

3. Spawning Areas. Activities in spawning areas during spawning seasons must be avoided to the maximum extent practicable. Activities that result in the physical destruction (e.g., through excavation, fill, or downstream smothering by substantial turbidity) of an important spawning area are not authorized.

4. Migratory Bird Breeding Areas. Activities in waters of the United States that serve as breeding areas for migratory birds must be avoided to the maximum extent practicable.

5. Shellfish Beds. No activity may occur in areas of concentrated shellfish populations, unless the activity is directly related to a shellfish harvesting activity authorized by NWPs 4 and 48, or is a shellfish seeding or habitat restoration activity authorized by NWP 27.

6. Suitable Material. No activity may use unsuitable material (e.g., trash, debris, car bodies, asphalt, etc.). Material used for construction or discharged must be free from toxic pollutants in toxic amounts (see section 307 of the Clean Water Act).

7. Water Supply Intakes. No activity may occur in the proximity of a public water supply intake, except where the activity is for the repair or improvement of public water supply intake structures or adjacent bank stabilization.

8. Adverse Effects From Impoundments. If the activity creates an impoundment of water, adverse effects to the aquatic system due to accelerating the passage of water, and/or restricting its flow must be minimized to the maximum extent practicable.

Enclosure 4

9. Management of Water Flows. To the maximum extent practicable, the pre-construction course, condition, capacity, and location of open waters must be maintained for each activity, including stream channelization, storm water management activities, and temporary and permanent road crossings, except as provided below. The activity must be constructed to withstand expected high flows. The activity must not restrict or impede the passage of normal or high flows, unless the primary purpose of the activity is to impound water or manage high flows. The activity may alter the pre-construction course, condition, capacity, and location of open waters if it benefits the aquatic environment (e.g., stream restoration or relocation activities).

10. Fills Within 100-Year Floodplains. The activity must comply with applicable FEIMA-approved state or local floodplain management requirements.

11. Equipment. Heavy equipment working in wetlands or mudflats must be placed on mats, or other measures must be taken to minimize soil disturbance.

12. Soil Erosion and Sediment Controls. Appropriate soil erosion and sediment controls must be used and maintained in effective operating condition during construction, and all exposed soil and other fills, as well as any work below the ordinary high water mark or high tide line, must be permanently stabilized at the earliest practicable date. Permittees are encouraged to perform work within waters of the United States during periods of low-flow or no-flow, or during low tides.

13. Removal of Temporary Fills. Temporary fills must be removed in their entirety and the affected areas returned to pre-construction elevations. The affected areas must be revegetated, as appropriate.

14. Proper Maintenance. Any authorized structure or fill shall be properly maintained, including maintenance to ensure public safety and compliance with applicable NWP general conditions, as well as any activity-specific conditions added by the district engineer to an NWP authorization.

15. Single and Complete Project. The activity must be a single and complete project. The same NWP cannot be used more than once for the same single and complete project.

16. Wild and Scenic Rivers.

(a) No NWP activity may occur in a component of the National Wild and Scenic River System, or in a river officially designated by Congress as a "study river" for possible inclusion in the system while the river is in an official study status, unless the appropriate Federal agency with direct management responsibility for such river, has determined in writing that the proposed activity will not adversely affect the Wild and Scenic River designation or study status.

(b) If a proposed NWP activity will occur in a component of the National Wild and Scenic River System, or in a river officially designated by Congress as a "study river" for possible inclusion in the system while the river is in an official study status, the permittee must submit a pre-construction notification (see general condition 32). The district engineer will coordinate the PCN with the Federal agency with direct management responsibility for that river. The permittee shall not begin the NWP activity until notified by the district engineer that the Federal agency with direct management responsibility for that river has determined in writing that the proposed NWP activity will not adversely affect the Wild and Scenic River designation or study status.

(c) Information on Wild and Scenic Rivers may be obtained from the appropriate Federal land management agency responsible for the designated Wild and Scenic River or study river (e.g.,

National Park Service, U.S. Forest Service, Bureau of Land Management, U.S. Fish and Wildlife Service). Information on these rivers is also available at: <http://www.rivers.gov/>.

17. Tribal Rights. No NWP activity may cause more than minimal adverse effects on tribal rights (including treaty rights), protected tribal resources, or tribal lands.

18. Endangered Species.

(a) No activity is authorized under any NWP which is likely to directly or indirectly jeopardize the continued existence of a threatened or endangered species or a species proposed for such designation, as identified under the Federal Endangered Species Act (ESA), or which will directly or indirectly destroy or adversely modify the critical habitat of such species. No activity is authorized under any NWP which "may affect" a listed species or critical habitat, unless ESA section 7 consultation addressing the effects of the proposed activity has been completed. Direct effects are the immediate effects on listed species and critical habitat caused by the NWP activity. Indirect effects are those effects on listed species and critical habitat caused by the NWP activity and are later in time, but still are reasonably certain to occur. Federal agencies should follow their own procedures for complying with the requirements of the ESA. If pre-construction notification is required for the proposed activity, the Federal permittee must provide the district engineer with the appropriate documentation to demonstrate compliance with those requirements. The district engineer will verify that the appropriate documentation has been submitted. If the appropriate documentation has not been submitted, additional ESA section 7 consultation may be necessary for the activity and the respective federal agency would be responsible for fulfilling its obligation under section 7 of the ESA.

(c) Non-federal permittees must submit a pre-construction notification to the district engineer if any listed species or designated critical habitat might be affected or is in the vicinity of the activity, or if the activity is located in designated critical habitat, and shall not begin work on the activity until notified by the district engineer that the requirements of the ESA have been satisfied and that the activity is authorized. For activities that might affect Federally-listed endangered or threatened species or designated critical habitat, the pre-construction notification must include the name(s) of the endangered or threatened species that might be affected by the proposed activity or that utilize the designated critical habitat that might be affected by the proposed activity. The district engineer will determine whether the proposed activity "may affect" or will have "no effect" to listed species and designated critical habitat and will notify the non-Federal applicant of the Corps' determination within 45 days of receipt of a complete pre-construction notification. In cases where the non-Federal applicant has identified listed species or critical habitat that might be affected or is in the vicinity of the activity, and has so notified the Corps, the applicant shall not begin work until the Corps has provided notification that the proposed activity will have "no effect" on listed species or critical habitat, or until ESA section 7 consultation has been completed. If the non-Federal applicant has not heard back from the Corps within 45 days, the applicant must still wait for notification from the Corps.

(d) As a result of formal or informal consultation with the FWS or NMFS the district engineer may add species-specific permit conditions to the NWPs.

(e) Authorization of an activity by an NWP does not authorize the "take" of a threatened or endangered species as defined under the ESA. In the absence of separate authorization (e.g., an ESA Section 10 Permit, a Biological Opinion with "incidental take" provisions, etc.) from the FWS or the NMFS, the Endangered Species Act prohibits any person subject to the jurisdiction of the United States to take a listed species, where "take" means to harass, harm, pursue, hunt, shoot, wound, kill, trap, capture, or collect, or to attempt to engage in any such conduct. The word "harm" in the definition of "take" means an act which actually kills or injures wildlife. Such

an act may include significant habitat modification or degradation where it actually kills or injures wildlife by significantly impairing essential behavioral patterns, including breeding, feeding or sheltering.

- (f) If the non-federal permittee has a valid ESA section 10(a)(1)(B) incidental take permit with an approved Habitat Conservation Plan for a project or a group of projects that includes the proposed NWP activity, the non-federal applicant should provide a copy of that ESA section 10(a)(1)(B) permit with the PCN required by paragraph (c) of this general condition. The district engineer will coordinate with the agency that issued the ESA section 10(a)(1)(B) permit to determine whether the proposed NWP activity and the associated incidental take were considered in the internal ESA section 7 consultation conducted for the ESA section 10(a)(1)(B) permit. If that coordination results in concurrence from the agency that the proposed NWP activity and the associated incidental take were considered in the internal ESA section 7 consultation for the ESA section 10(a)(1)(B) permit, the district engineer does not need to conduct a separate ESA section 7 consultation for the proposed NWP activity. The district engineer will notify the non-federal applicant within 45 days of receipt of a complete pre-construction notification whether the ESA section 10(a)(1)(B) permit covers the proposed NWP activity or whether additional ESA section 7 consultation is required.
- (g) Information on the location of threatened and endangered species and their critical habitat can be obtained directly from the offices of the FWS and NMFS or their world wide Web pages at <http://www.fws.gov/> or <http://www.fws.gov/ipac> and <http://www.nmfs.noaa.gov/pr/species/esa/> respectively.

19. Migratory Birds and Bald and Golden Eagles. The permittee is responsible for ensuring their action complies with the Migratory Bird Treaty Act and the Bald and Golden Eagle Protection Act. The permittee is responsible for contacting appropriate local office of the U.S. Fish and Wildlife Service to determine applicable measures to reduce impacts to migratory birds or eagles, including whether "incidental take" permits are necessary and available under the Migratory Bird Treaty Act or Bald and Golden Eagle Protection Act for a particular activity.

20. Historic Properties.

- (a) In cases where the district engineer determines that the activity may have the potential to cause effects to properties listed, or eligible for listing, in the National Register of Historic Places, the activity is not authorized, until the requirements of Section 106 of the National Historic Preservation Act (NHPA) have been satisfied.
- (b) Federal permittees should follow their own procedures for complying with the requirements of section 106 of the National Historic Preservation Act. If pre-construction notification is required for the proposed NWP activity, the Federal permittee must provide the district engineer with the appropriate documentation to demonstrate compliance with those requirements. The district engineer will verify that the appropriate documentation has been submitted. If the appropriate documentation is not submitted, then additional consultation under section 106 may be necessary. The respective federal agency is responsible for fulfilling its obligation to comply with section 106.
- (c) Non-federal permittees must submit a pre-construction notification to the district engineer if the NWP activity might have the potential to cause effects to any historic properties listed on, determined to be eligible for listing on, or potentially eligible for listing on the National Register of Historic Places, including previously unidentified properties. For such activities, the pre-construction notification must state which historic properties might have the potential to be affected by the proposed NWP activity or include a vicinity map indicating the location of the historic properties or the potential for the presence of historic properties. Assistance regarding

information on the location of, or potential for, the presence of historic properties can be sought from the State Historic Preservation Officer, Tribal Historic Preservation Officer, or designated tribal representative, as appropriate, and the National Register of Historic Places (see 33 CFR 330.4(g)). When reviewing pre-construction notifications, district engineers will comply with the current procedures for addressing the requirements of section 106 of the National Historic Preservation Act. The district engineer shall make a reasonable and good faith effort to carry out appropriate identification efforts, which may include background research, consultation, oral history interviews, sample field investigation, and field survey. Based on the information submitted in the PCN and these identification efforts, the district engineer shall determine whether the proposed NWP activity has the potential to cause effects on the historic properties. Section 106 consultation is not required when the district engineer determines that the activity does not have the potential to cause effects on historic properties (see 36 CFR 800.3(a)). Section 106 consultation is required when the district engineer determines that the activity has the potential to cause effects on historic properties. The district engineer will conduct consultation with consulting parties identified under 36 CFR 800.2(c) when he or she makes any of the following effect determinations for the purposes of section 106 of the NHPA: no historic properties affected, no adverse effect, or adverse effect. Where the non-Federal applicant has identified historic properties on which the activity might have the potential to cause effects and so notified the Corps, the non-Federal applicant shall not begin the activity until notified by the district engineer either that the activity has no potential to cause effects to historic properties or that NHPA section 106 consultation has been completed.

- (d) For non-federal permittees, the district engineer will notify the prospective permittee within 45 days of receipt of a complete pre-construction notification whether NHPA section 106 consultation is required. If NHPA section 106 consultation is required, the district engineer will notify the non-Federal applicant that he or she cannot begin the activity until section 106 consultation is completed. If the non-Federal applicant has not heard back from the Corps within 45 days, the applicant must still wait for notification from the Corps.
- (e) Prospective permittees should be aware that section 110k of the NHPA (54 U.S.C. 306113) prevents the Corps from granting a permit or other assistance to an applicant who, with intent to avoid the requirements of section 106 of the NHPA, has intentionally significantly adversely affected a historic property to which the permit would relate, or having legal power to prevent it, allowed such significant adverse effect to occur, unless the Corps, after consultation with the Advisory Council on Historic Preservation (ACHP), determines that circumstances justify granting such assistance despite the adverse effect created or permitted by the applicant. If circumstances justify granting the assistance, the Corps is required to notify the ACHP and provide documentation specifying the circumstances, the degree of damage to the integrity of any historic properties affected, and proposed mitigation. This documentation must include any views obtained from the applicant, SHPO/THPO, appropriate Indian tribes if the undertaking occurs on or affects historic properties on tribal lands or affects properties of interest to those tribes, and other parties known to have a legitimate interest in the impacts to the permitted activity on historic properties.

21. Discovery of Previously Unknown Remains and Artifacts. If you discover any previously unknown historic, cultural or archeological remains and artifacts while accomplishing the activity authorized by this permit, you must immediately notify the district engineer of what you have found, and to the maximum extent practicable, avoid construction activities that may affect the remains and artifacts until the required coordination has been completed. The district engineer will initiate the Federal, Tribal, and state coordination required to determine if the items or remains warrant a recovery effort or if the site is eligible for listing in the National Register of Historic Places.

22. Designated Critical Resource Waters. Critical resource waters include, NOAA-managed marine sanctuaries and marine monuments, and National Estuarine Research Reserves. The district engineer may designate, after notice and opportunity for public comment, additional waters as outstanding national resource waters or state natural heritage sites. The district engineer may also designate additional critical resource waters after notice and opportunity for public comment.

- (a) Discharges of dredged or fill material into waters of the United States are not authorized by NWP's 7, 12, 14, 16, 17, 21, 29, 31, 35, 39, 40, 42, 43, 44, 49, 50, 51, and 52 for any activity within, or directly affecting, critical resource waters, including wetlands adjacent to such waters.
- (b) For NWP's 3, 8, 10, 13, 15, 18, 19, 22, 23, 25, 27, 28, 30, 33, 34, 36, 37, 38, and 54, notification is required in accordance with general condition 32, for any activity proposed in the designated critical resource waters including wetlands adjacent to those waters. The district engineer may authorize activities under these NWP's only after it is determined that the impacts to the critical resource waters will be no more than minimal.

23. Mitigation. The district engineer will consider the following factors when determining appropriate and practicable mitigation necessary to ensure that the individual and cumulative adverse environmental effects are no more than minimal:

- (a) The activity must be designed and constructed to avoid and minimize adverse effects, both temporary and permanent, to waters of the United States to the maximum extent practicable at the project site (i.e., on site).
- (b) Mitigation in all its forms (avoiding, minimizing, rectifying, reducing, or compensating for resource losses) will be required to the extent necessary to ensure that the individual and cumulative adverse environmental effects are no more than minimal.
- (c) Compensatory mitigation at a minimum one-for-one ratio will be required for all wetland losses that exceed 1/10-acre and require pre-construction notification, unless the district engineer determines in writing that either some other form of mitigation would be more environmentally appropriate or the adverse environmental effects of the proposed activity are no more than minimal, and provides an activity-specific waiver of this requirement. For wetland losses of 1/10-acre or less that require pre-construction notification, the district engineer may determine on a case-by-case basis that compensatory mitigation is required to ensure that the activity results in only minimal adverse environmental effects.
- (d) For losses of streams or other open waters that require pre-construction notification, the district engineer may require compensatory mitigation to ensure that the activity results in no more than minimal adverse environmental effects. Compensatory mitigation for losses of streams should be provided, if practicable, through stream rehabilitation, enhancement, or preservation, since streams are difficult-to-replace resources (see 33 CFR 332.3(e)(3)).
- (e) Compensatory mitigation plans for NWP activities in or near streams or other open waters will normally include a requirement for the restoration or enhancement, maintenance, and legal protection (e.g., conservation easements) of riparian areas next to open waters. In some cases, the restoration or maintenance/protection of riparian areas may be the only compensatory mitigation required. Restored riparian areas should consist of native species. The width of the required riparian area will address documented water quality or aquatic habitat loss concerns. Normally, the riparian area will be 25 to 50 feet wide on each side of the stream, but the district engineer may require slightly wider riparian areas to address documented water quality or habitat loss concerns. If it is not possible to restore or maintain/protect a riparian area on both

sides of a stream, or if the waterbody is a lake or coastal waters, then restoring or maintaining/protecting a riparian area along a single bank or shoreline may be sufficient. Where both wetlands and open waters exist on the project site, the district engineer will determine the appropriate compensatory mitigation (e.g., riparian areas and/or wetlands compensation) based on what is best for the aquatic environment on a watershed basis. In cases where riparian areas are determined to be the most appropriate form of minimization or compensatory mitigation, the district engineer may waive or reduce the requirement to provide wetland compensatory mitigation for wetland losses.

- (f) Compensatory mitigation projects provided to offset losses of aquatic resources must comply with the applicable provisions of 33 CFR part 332.
- (1) The prospective permittee is responsible for proposing an appropriate compensatory mitigation option if compensatory mitigation is necessary to ensure that the activity results in no more than minimal adverse environmental effects. For the NWP's, the preferred mechanism for providing compensatory mitigation is mitigation bank credits or in-lieu fee program credits (see 33 CFR 332.3(b)(2) and (3)). However, if an appropriate number and type of mitigation bank or in-lieu credits are not available at the time the PCN is submitted to the district engineer, the district engineer may approve the use of permittee-responsible mitigation.
- (2) The amount of compensatory mitigation required by the district engineer must be sufficient to ensure that the authorized activity results in no more than minimal individual and cumulative adverse environmental effects (see 33 CFR 330.1(e)(3)). (See also 33 CFR 332.3(f)).
- (3) Since the likelihood of success is greater and the impacts to potentially valuable uplands are reduced, aquatic resource restoration should be the first compensatory mitigation option considered for permittee-responsible mitigation.
- (4) If permittee-responsible mitigation is the proposed option, the prospective permittee is responsible for submitting a mitigation plan. A conceptual or detailed mitigation plan may be used by the district engineer to make the decision on the NWP verification request, but a final mitigation plan that addresses the applicable requirements of 33 CFR 332.4(c)(2) through (14) must be approved by the district engineer before the permittee begins work in waters of the United States, unless the district engineer determines that prior approval of the final mitigation plan is not practicable or not necessary to ensure timely completion of the required compensatory mitigation (see 33 CFR 332.3(k)(3)).
- (5) If mitigation bank or in-lieu fee program credits are the proposed option, the mitigation plan only needs to address the baseline conditions at the impact site and the number of credits to be provided.
- (6) Compensatory mitigation requirements (e.g., resource type and amount to be provided as compensatory mitigation, site protection, ecological performance standards, monitoring requirements) may be addressed through conditions added to the NWP authorization, instead of components of a compensatory mitigation plan (see 33 CFR 332.4(c)(1)(ii)).
- (g) Compensatory mitigation will not be used to increase the acreage losses allowed by the acreage limits of the NWP's. For example, if an NWP has an acreage limit of 1/2-acre, it cannot be used to authorize any NWP activity resulting in the loss of greater than 1/2-acre of waters of the United States, even if compensatory mitigation is provided that replaces or restores some of the lost waters. However, compensatory mitigation can and should be used, as necessary, to ensure that an NWP activity already meeting the established acreage limits also satisfies the no more than minimal impact requirement for the NWP's.
- (h) Permittees may propose the use of mitigation banks, in-lieu fee programs, or permittee-responsible mitigation. When developing a compensatory mitigation proposal, the permittee

must consider appropriate and practicable options consistent with the framework at 33 CFR 332.3(b). For activities resulting in the loss of marine or estuarine resources, permittee-responsible mitigation may be environmentally preferable if there are no mitigation banks or in-lieu fee programs in the area that have marine or estuarine credits available for sale or transfer to the permittee. For permittee-responsible mitigation, the special conditions of the NWP verification must clearly indicate the party or parties responsible for the implementation and performance of the compensatory mitigation project, and, if required, its long-term management.

(i) Where certain functions and services of waters of the United States are permanently adversely affected by a regulated activity, such as discharges of dredged or fill material into waters of the United States that will convert a forested or scrub-shrub wetland to a herbaceous wetland in a permanently maintained utility line right-of-way, mitigation may be required to reduce the adverse environmental effects of the activity to the no more than minimal level.

24. Safety of Impoundment Structures. To ensure that all impoundment structures are safely designed, the district engineer may require non-Federal applicants to demonstrate that the structures comply with established state dam safety criteria or have been designed by qualified persons. The district engineer may also require documentation that the design has been independently reviewed by similarly qualified persons, and appropriate modifications made to ensure safety.

25. Water Quality. Where States and authorized Tribes, or EPA where applicable, have not previously certified compliance of an NWP with CWA section 401, individual 401 Water Quality Tribe may require or waived (see 33 CFR 330.4(c)). The district engineer or State or Tribe may require additional water quality management measures to ensure that the authorized activity does not result in more than minimal degradation of water quality.

26. Coastal Zone Management. In coastal states where an NWP has not previously received a state coastal zone management consistency concurrence, an individual state coastal zone management consistency concurrence must be obtained, or a presumption of concurrence must occur (see 33 CFR 330.4(d)). The district engineer or a State may require additional measures to ensure that the authorized activity is consistent with state coastal zone management requirements.

27. Regional and Case-By-Case Conditions. The activity must comply with any regional conditions that may have been added by the Division Engineer (see 33 CFR 330.4(e)) and with any case specific conditions added by the Corps or by the state, Indian Tribe, or U.S. EPA in its section 401 Water Quality Certification, or by the state in its Coastal Zone Management Act consistency determination.

28. Use of Multiple Nationwide Permits. The use of more than one NWP for a single and complete project is prohibited, except when the acreage loss of waters of the United States authorized by the NWPs does not exceed the acreage limit of the NWP with the highest specified acreage limit. For example, if a road crossing over tidal waters is constructed under NWP 14, with associated bank stabilization authorized by NWP 13, the maximum acreage loss of waters of the United States for the total project cannot exceed 1/3-acre.

29. Transfer of Nationwide Permit Verifications. If the permittee sells the property associated with a nationwide permit verification, the permittee may transfer the nationwide permit verification to the new owner by submitting a letter to the appropriate Corps district office to validate the transfer.

A copy of the nationwide permit verification must be attached to the letter, and the letter must contain the following statement and signature:

When the structures or work authorized by this nationwide permit are still in existence at the time the property is transferred, the terms and conditions of this nationwide permit, including any special conditions, will continue to be binding on the new owner(s) of the property. To validate the transfer of this nationwide permit and the associated liabilities associated with compliance with its terms and conditions, have the transferee sign and date below.

(Transferee)

(Date)

30. Compliance Certification. Each permittee who receives an NWP verification letter from the Corps must provide a signed certification documenting completion of the authorized activity and implementation of any required compensatory mitigation. The success of any required permittee-responsible mitigation, including the achievement of ecological performance standards, will be addressed separately by the district engineer. The Corps will provide the permittee the certification document with the NWP verification letter. The certification document will include:

- (a) A statement that the authorized activity was done in accordance with the NWP authorization, including any general, regional, or activity-specific conditions;
- (b) A statement that the implementation of any required compensatory mitigation was completed in accordance with the permit conditions. If credits from a mitigation bank or in-lieu fee program are used to satisfy the compensatory mitigation requirements, the certification must include the documentation required by 33 CFR 332.3(f)(3) to confirm that the permittee secured the appropriate number and resource type of credits; and
- (c) The signature of the permittee certifying the completion of the activity and mitigation.

The completed certification document must be submitted to the district engineer within 30 days of completion of the authorized activity or the implementation of any required compensatory mitigation, whichever occurs later.

31. Activities Affecting Structures or Works Built by the United States. If an NWP activity also requires permission from the Corps pursuant to 33 U.S.C. 408 because it will alter or temporarily or permanently occupy or use a U.S. Army Corps of Engineers (USACE) federally authorized Civil Works project (a "USACE project"), the prospective permittee must submit a pre-construction notification. See paragraph (b)(10) of general condition 32. An activity that requires section 408 permission is not authorized by NWP until the appropriate Corps office issues the section 408 permission to alter, occupy, or use the USACE project, and the district engineer issues a written NWP verification.

32. Pre-Construction Notification.

(a) Timing. Where required by the terms of the NWP, the prospective permittee must notify the district engineer by submitting a pre-construction notification (PCN) as early as possible. The

district engineer must determine if the PCN is complete within 30 calendar days of the date of receipt and, if the PCN is determined to be incomplete, notify the prospective permittee within that 30 day period to request the additional information necessary to make the PCN complete. The request must specify the information needed to make the PCN complete. As a general rule, district engineers will request additional information necessary to make the PCN complete only once. However, if the prospective permittee does not provide all of the requested information, then the district engineer will notify the prospective permittee that the PCN is still incomplete and the PCN review process will not commence until all of the requested information has been received by the district engineer. The prospective permittee shall not begin the activity until either:

- (1) He or she is notified in writing by the district engineer that the activity may proceed under the NWP with any special conditions imposed by the district or division engineer, or
- (2) 45 calendar days have passed from the district engineer's receipt of the complete PCN and the prospective permittee has not received written notice from the district or division engineer. However, if the permittee was required to notify the Corps pursuant to general condition 18 that listed species or critical habitat might be affected or are in the vicinity of the activity, or to notify the Corps pursuant to general condition 20 that the activity might have the potential to cause effects to historic properties, the permittee cannot begin the activity until receiving written notification from the Corps that there is "no effect" on listed species or "no potential to cause effects" on historic properties, or that any consultation required under Section 7 of the Endangered Species Act (see 33 CFR 330.4(f)) and/or section 106 of the National Historic Preservation Act (see 33 CFR 330.4(g)) has been completed. Also, work cannot begin under NWPs 21, 49, or 50 until the permittee has received written approval from the Corps. If the proposed activity requires a written waiver to exceed specified limits of an NWP, the permittee may not begin the activity until the district engineer issues the waiver. If the district or division engineer notifies the permittee in writing that an individual permit is required within 45 calendar days of receipt of a complete PCN, the permittee cannot begin the activity until an individual permit has been obtained. Subsequently, the permittee's right to proceed under the NWP may be modified, suspended, or revoked only in accordance with the procedure set forth in 33 CFR 330.5(d)(2).

(b) Contents of Pre-Construction Notification: The PCN must be in writing and include the following information:

- (1) Name, address and telephone numbers of the prospective permittee;
 - (2) Location of the proposed activity;
 - (3) Identify the specific NWP or NWP(s) the prospective permittee wants to use to authorize the proposed activity;
 - (4) A description of:
 - environmental effects the activity would cause, including the anticipated amount of loss of wetlands, other special aquatic sites, and other waters expected to result from the NWP activity, in acres, linear feet, or other appropriate unit of measure; a description of any proposed mitigation measures intended to reduce the adverse environmental effects caused by the proposed activity; and any other NWP(s), regional general permit(s), or individual permit(s) used or intended to be used to authorize any part of the proposed project or any related activity, including other separate and distant crossings for linear projects that require Department of the Army authorization but do not require pre-construction notification. The description of the proposed activity and any proposed construction notification.
- mitigation measures should be sufficiently detailed to allow the district engineer to determine that the adverse environmental effects of the activity will be no more than minimal and to determine the need for compensatory mitigation or other mitigation measures. For single and complete linear projects, the PCN must include the quantity of anticipated losses of wetlands, other special aquatic sites, and other waters for each single and complete crossing of those wetlands, other special aquatic sites, and other waters. Sketches should be provided when necessary to show that the activity complies with the terms of the NWP. (Sketches usually clarify the activity and when provided results in a quicker decision. Sketches should contain sufficient detail to provide an illustrative description of the proposed activity (e.g., a conceptual plan), but do not need to be detailed engineering plans);
- (5) The PCN must include a delineation of wetlands, other special aquatic sites, and other waters, such as lakes and ponds, and perennial, intermittent, and ephemeral streams, on the project site. Wetland delineations must be prepared in accordance with the current method required by the Corps. The permittee may ask the Corps to delineate the special aquatic sites and other waters on the project site, but there may be a delay if the Corps does the delineation, especially if the project site is large or contains many wetlands, other special aquatic sites, and other waters. Furthermore, the 45 day period will not start until the delineation has been submitted to or completed by the Corps, as appropriate; if the proposed activity will result in the loss of greater than 1/10-acre of wetlands and a PCN is required, the prospective permittee must submit a statement describing how the mitigation requirement will be satisfied, or explaining why the adverse environmental effects are no more than minimal and why compensatory mitigation should not be required. As an alternative, the prospective permittee may submit a conceptual or detailed mitigation plan.
 - (7) For non-Federal permittees, if any listed species or designated critical habitat might be affected or is in the vicinity of the activity, or if the activity is located in designated critical habitat, the PCN must include the name(s) of those endangered or threatened species that might be affected by the proposed activity or utilize the designated critical habitat that might be affected by the proposed activity. For NWP activities that require pre-construction notification, Federal permittees must provide documentation demonstrating compliance with the Endangered Species Act;
 - (8) For non-Federal permittees, if the NWP activity might have the potential to cause effects to a historic property listed on, determined to be eligible for listing on, or potentially eligible for listing on, the National Register of Historic Places, the PCN must state which historic property might have the potential to be affected by the proposed activity or include a vicinity map indicating the location of the historic property. For NWP activities that require pre-construction notification, Federal permittees must provide documentation demonstrating compliance with section 106 of the National Historic Preservation Act;
 - (9) For an activity that will occur in a component of the National Wild and Scenic River System, or in a river officially designated by Congress as a "study river" for possible inclusion in the system while the river is in an official study status, the PCN must identify the Wild and Scenic River or the "study river" (see general condition 16); and
 - (10) For an activity that requires permission from the Corps pursuant to 33 U.S.C. 408 because it will alter or temporarily or permanently occupy or use a U.S. Army Corps of Engineers federally authorized civil works project, the pre-construction notification must include a statement confirming that the project proponent has submitted a written request for section 408 permission from the Corps office having jurisdiction over that USACE project.

(c) Form of Pre-Construction Notification: The standard individual permit application form (Form ENG 4345) may be used, but the completed application form must clearly indicate that it is an NWP PCN and must include all of the applicable information required in paragraphs (b)(1) through (10) of this general condition. A letter containing the required information may also be used. Applicants may provide electronic files of PCNs and supporting materials if the district engineer has established tools and procedures for electronic submittals.

(d) Agency Coordination:

- (1) The district engineer will consider any comments from Federal and state agencies concerning the proposed activity's compliance with the terms and conditions of the NWPs and the need for mitigation to reduce the activity's adverse environmental effects so that they are no more than minimal.
- (2) Agency coordination is required for: (i) All NWP activities that require pre-construction notification and result in the loss of greater than 1/2-acre of waters of the United States; (ii) NWP 21, 29, 39, 40, 42, 43, 44, 50, 51, and 52 activities that require pre-construction notification and will result in the loss of greater than 300 linear feet of stream bed; (iii) NWP 13 activities in excess of 500 linear feet, fills greater than one cubic yard per running foot, or involve discharges of dredged or fill material into special aquatic sites; and (iv) NWP 54 activities in excess of 500 linear feet, or that extend into the waterbody more than 30 feet from the mean low water line in tidal waters or the ordinary high water mark in the Great Lakes.
- (3) When agency coordination is required, the district engineer will immediately provide (e.g., via email, facsimile transmission, overnight mail, or other expeditious manner) a copy of the complete PCN to the appropriate Federal or state offices (FWS, state natural resource or water quality agency, EPA, and, if appropriate, the NMFS). With the exception of NWP 37, these agencies will have 10 calendar days from the date the material is transmitted to notify the district engineer via telephone, facsimile transmission, or email that they intend to provide substantive, site-specific comments. The comments must explain why the agency believes the adverse environmental effects will be more than minimal. If so contacted by an agency, the district engineer will wait an additional 15 calendar days before making a decision on the pre-construction notification. The district engineer will fully consider agency comments received within the specified time frame concerning the proposed activity's compliance with the terms and conditions of the NWPs, including the need for mitigation to ensure the net adverse environmental effects of the proposed activity are no more than minimal. The district engineer will provide no response to the resource agency, except as provided below. The district engineer will indicate in the administrative record associated with each pre-construction notification that the resource agencies' concerns were considered. For NWP 37, the emergency watershed protection and rehabilitation activity may proceed immediately in cases where there is an unacceptable hazard to life or a significant loss of property or economic hardship will occur. The district engineer will consider any comments received to decide whether the NWP 37 authorization should be modified, suspended, or revoked in accordance with the procedures at 33 CFR 330.5.
- (4) In cases where the prospective permittee is not a Federal agency, the district engineer will provide a response to NMFS within 30 calendar days of receipt of any Essential Fish Habitat conservation recommendations, as required by section 305(b)(4)(B) of the Magnuson-Stevens Fishery Conservation and Management Act.

(5) Applicants are encouraged to provide the Corps with either electronic files or multiple copies of pre-construction notifications to expedite agency coordination.

Further Information

1. District Engineers have authority to determine if an activity complies with the terms and conditions of an NWP.
2. NWPs do not obviate the need to obtain other federal, state, or local permits, approvals, or authorizations required by law.
3. NWPs do not grant any property rights or exclusive privileges.
4. NWPs do not authorize any injury to the property or rights of others.
5. NWPs do not authorize interference with any existing or proposed Federal project (see general condition 3f).



US Army Corps
of Engineers @
Nashville District

COMPLIANCE CERTIFICATION

YOU ARE REQUIRED TO SUBMIT THIS SIGNED CERTIFICATION REGARDING THE COMPLETED ACTIVITY AND ANY REQUIRED MITIGATION

I hereby certify that the work authorized by Permit No. LRN-2018-00736 and any required mitigation was done in accordance with the Corps authorization, including any general, regional, or special conditions.

Permittee Signature

Date

Please note that your permitted activity is subject to a compliance inspection by an U.S. Army Corps of Engineers representative.

Submit this signed certification to the address below:

- U.S Army Corps of Engineers
Regulatory Division
3701 Bell Road
Nashville, TN 37214-266
Attn: Floyd M. Carnes
- East Regulatory Field Office
501 Adesa Parkway
Suite 250
Lenoir City, TN 37771
- West Regulatory Field Office
2042 Beltline Road, Southwest
Building C, Suite 415
Decatur, Al 35601



MATTHEW G. BEVIN
GOVERNOR

CHARLES G. SNAVELY
SECRETARY

ENERGY AND ENVIRONMENT CABINET
DEPARTMENT FOR ENVIRONMENTAL PROTECTION

R. BRUCE SCOTT
COMMISSIONER

300 SOWER BOULEVARD
FRANKFORT, KENTUCKY 40601

**General Certification--Nationwide Permit # 12
Utility Line Backfill and Bedding**

This General Certification is issued March 19, 2017, in conformity with the requirements of Section 401 of the Clean Water Act of 1977, as amended (33 U.S.C. §1341), as well as Kentucky Statute KRS 224.16-050.

For this and all nationwide permits, the definition of surface water is as per 401 KAR 10:001 Chapter 10, Section 1(80): Surface Waters means those waters having well-defined banks and beds, either constantly or intermittently flowing; lakes and impounded waters; marshes and wetlands; and any subterranean waters flowing in well-defined channels and having a demonstrable hydrologic connection with the surface. Lagoons used for waste treatment and effluent ditches that are situated on property owned, leased, or under valid easement by a permitted discharger are not considered to be surface waters of the commonwealth.

Agricultural operations, as defined by KRS 224.71-100(1) conducting activities pursuant to KRS 224.71-100 (3), (4), (5), (6), or 10 are deemed to have certification if they are implementing an Agriculture Water Quality Plan pursuant to KRS 224.71-145.

For all other operations, the Commonwealth of Kentucky hereby certifies under Section 401 of the Clean Water Act (CWA) that it has reasonable assurances that applicable water quality standards under Kentucky Administrative Regulations Title 401, Chapter 10, established pursuant to Sections 301, 302, 304, 306 and 307 of the CWA, will not be violated for the activity covered under NATIONWIDE PERMIT 12, namely Utility Line Backfill and Bedding, provided that the following conditions are met:

1. The activity will not occur within surface waters of the Commonwealth identified by the Kentucky Division of Water as Outstanding State or National Resource Water, Cold Water Aquatic Habitat, or Exceptional Waters.
2. The activity will not occur within surface waters of the Commonwealth identified as perpetually-protected (e.g. deed restriction, conservation easement) mitigation sites.

General Certification--Nationwide Permit # 12
Utility Line Backfill and Bedding
Page 2

3. This general water quality certification is limited to the crossing of surface waters by utility lines. This document does not authorize the installation of utility lines in a linear manner within the stream channel or below the top of the stream bank.
4. For a single crossing, impacts from the construction and maintenance corridor in surface waters shall not exceed 50 feet of bank disturbance.
5. This general certification shall not apply to projects where multiple nationwide permits are issued for individual crossings which are part of a single, larger utility line project where the cumulative impacts exceed ½ acre of wetlands or 300 linear feet of surface waters. Cumulative impacts include utility line crossings, permanent or temporary access roads, headwalls, associated bank stabilization areas, substations, pole or tower foundations, maintenance corridor, and staging areas.
6. Stream impacts under Conditions 4 and 5 of this certification are defined as the length of bank disturbed. For utility line crossings and roads, only one bank length is used in calculation of the totals.
7. Any crossings must be constructed in a manner that does not impede natural water flow.
8. Stream impacts covered under this General Water Quality Certification and undertaken by those persons defined as an agricultural operation under the Agricultural Water Quality Act must be completed in compliance with the Kentucky Agricultural Water Quality Plan (KWQP).
9. The Kentucky Division of Water may require submission of a formal application for an individual certification for any project if the project has been determined to likely have a significant adverse effect upon water quality or degrade the waters of the Commonwealth so that existing uses of the water body or downstream waters are precluded.
10. Activities that do not meet the conditions of this General Water Quality Certification require an Individual Section 401 Water Quality Certification.
11. Blasting of stream channels, even under dry conditions, is not allowed under this general water quality certification.
12. Utility lines placed parallel to the stream shall be located at least 50 feet from an intermittent or perennial stream, measured from the top of the stream bank. The cabinet may allow construction within the 50 foot buffer if avoidance and minimization efforts are shown and adequate methods are utilized to prevent soil from entering the stream.

13. Utility line stream crossings shall be constructed by methods that maintain flow and allow for a dry excavation. Water pumped from the excavation shall be contained and allowed to settle prior to re-entering the stream. Excavation equipment and vehicles shall operate outside of the flowing portion of the stream. Spoil material from the excavation shall not be allowed to enter the flowing portion of the stream.
14. The activities shall not result in any permanent changes in pre-construction elevation contours in surface waters or wetlands or stream dimension, pattern or profile.
15. Utility line activities which impact wetlands shall not result in conversion of the area to non-wetland status. Mechanized land clearing of forested wetlands for the installation or maintenance of utility lines is not authorized under this certification.
16. Activities qualifying for coverage under this General Water Quality Certification are subject to the following conditions:
 - Projects requiring in-stream stormwater detention/retention basins shall require individual water quality certifications.
 - Erosion and sedimentation pollution control plans and Best Management Practices must be designed, installed, and maintained in effective operating condition at all times during construction activities so that violations of state water quality standards do not occur.
 - Sediment and erosion control measures, such as check-dams constructed of any material, silt fencing, hay bales, etc., shall not be placed within surface waters of the Commonwealth, either temporarily or permanently, without prior approval by the Kentucky Division of Water's Water Quality Certification Section. If placement of sediment and erosion control measures in surface waters is unavoidable, design and placement of temporary erosion control measures shall not be conducted in such a manner that may result in instability of streams that are adjacent to, upstream, or downstream of the structures. All sediment and erosion control devices shall be removed and the natural grade restored within the completion timeline of the activities.
 - Measures shall be taken to prevent or control spills of fuels, lubricants, or other toxic materials used in construction from entering the watercourse.
 - Removal of riparian vegetation shall be limited to that necessary for equipment access.
 - To the maximum extent practicable, all in-stream work under this certification shall be performed under low-flow conditions.
 - Heavy equipment, e.g. bulldozers, backhoes, draglines, etc., if required for this project, should not be used or operated within the stream channel. In those instances in which such in-stream work is unavoidable, then it shall

General Certification--Nationwide Permit # 12
Utility Line Backfill and Bedding
Page 4

- be performed in such a manner and duration as to minimize turbidity and disturbance to substrates and bank or riparian vegetation.
- Any fill shall be of such composition that it will not adversely affect the biological, chemical, or physical properties of the receiving waters and/or cause violations of water quality standards. If rip-rap is utilized, it should be of such weight and size that bank stress or slump conditions will not be created because of its placement.
 - If there are water supply intakes located downstream that may be affected by increased turbidity and suspended solids, the permittee shall notify the operator when such work will be done.
 - Should evidence of stream pollution or jurisdictional wetland impairment and/or violations of water quality standards occur as a result of this activity (either from a spill or other forms of water pollution), the Kentucky Division of Water shall be notified immediately by calling (800) 928-2380.

Non-compliance with the conditions of this general certification or violation of Kentucky state water quality standards may result in civil penalties.

WATER QUALITY GENERAL CERTIFICATION
OF UTILITY LINE ACTIVITIES ALONG STREAMS
IN EFFECT: MARCH 19, 2017

Condition 12 of the March 19, 2017 Section 401 Water Quality Certification (WQC) of the U.S. Army Corps of Engineers' Nationwide Permit (NWP) # 12 Utility Line Backfill and Bedding states:

Utility lines placed parallel to the stream shall be located at least 50 feet from an intermittent or perennial stream, measured from the top of the stream bank. The cabinet may allow for construction within the 50-ft buffer if avoidance and minimization efforts are shown and adequate methods are utilized to prevent soil from entering the stream.

If a utility line project qualifies for a general certification of NWP 12 and is within 50 feet of the stream bank, a WQC application and a site-specific sediment and erosion control plan must be submitted for review by WQC before construction and construction-related activities can proceed. This is in addition to the Stormwater Pollution Prevention Plans for construction sites one (1) acre or more in size. Approval of the sediment and erosion control plan by the WQC Section is required before construction activities can begin.

WHY SEDIMENT AND EROSION CONTROL PLANS AND PRACTICES?

Construction activities near streams, rivers, and lakes have the potential to cause water pollution and stream degradation if erosion and sediment controls are not properly installed and maintained. In order to effectively reduce erosion and sedimentation impacts, plans and practices must be designed, located, installed, and maintained in effective operating condition at all times during land disturbing activities to prevent the discharge of sediment and other pollutants into waters of the Commonwealth. Sediment is a major contributor to the pollution of surface waters in Kentucky and construction activities are a major source of sediment and stream siltation. Disturbed soil, if not managed properly, can be washed off-site during storms and can cause major impairment in the receiving waters. Excessive silt causes adverse impacts such as disruption of aquatic organism life cycles, reduced passage, higher drinking water treatment costs for sediment removal, and the alteration of waters' physical/chemical properties, resulting in degradation of its quality. Therefore, erosion prevention and sediment control practices are the key parameter for successful water quality protection.

Applicants should design the site construction and development by selecting erosion prevention and sediment controls and practices to accommodate the unique hydrologic and geologic conditions of the site. Some of the factors to be considered include: local development requirements and/or codes, precipitation patterns for the area when the project will be underway, soil types, slopes, layout of structures for the site, sensitivity of nearby waters and natural areas, and safety concerns. A number of structural practices (e.g., mulching, vegetated buffer strips, grassed swales, retention/detention ponds, silt fence and hay bale barriers, stone check dams, inlet protection, infiltration practices) and non-structural practices (minimizing disturbance, good housekeeping) have shown to be efficient, cost effective, and versatile for construction site developers to implement.

EROSION PREVENTION AND SEDIMENT CONTROL STRATEGIES

Appropriate erosion prevention and sediment control measures and other stormwater management practices must be designed, installed, and maintained. Applicants are encouraged to perform work within

surface waters during periods of low-flow or no-flow. To ensure that all sources of soil erosion and sediment on the construction site are adequately controlled, the following strategies should be employed:

- **Sediment and erosion control measures shall not be placed in surface waters.** The design and placement of temporary erosion control measures shall not be conducted in a manner that may result in disruption of flow in wetlands or streams.
- **Maximize the protection of existing vegetation.** Natural vegetation should be retained, protected or supplemented to the maximum extent practical, and vegetation not intended for removal should be adequately marked, fenced, or flagged as necessary.
- **Avoid disturbing critical areas.** Areas such as sinkholes, streams, wetlands, stream buffers, highly erodible soils, and steep slopes should be avoided to the greatest extent feasible. Mark, fence or flag areas in the field that should be protected from construction activities such as clearing, grubbing, grading, mowing, staging activities, material storage and/or other related activities.
- **Minimize size and duration of disturbed soil.** Limit site preparation of activities such as grading and clearing to where they are absolutely necessary and consistent with plan and daily schedules of construction activities.
- **Manage stormwater.** Prevent stormwater from entering areas and leaving areas of disturbed soil by using vegetated strips, diversion dikes and swales, filter berms, sediment traps and basins, check dams, stabilized construction entrances, and silt fences or filter tubes/wattles. Reduce the amount of sediment and water velocity produced from areas of disturbed soils by using vegetation, riprap, sod, seeding and mulching or blankets, as well as the use of structural measures including diversion, check dams, slope drains, and storm drain protection.
- **Stabilize soils.** Stabilize soil with seeding and mulch as soon as possible after disturbance. Soil disturbed by construction activities should be stabilized within 14 days of ceasing construction activities. Erosion prevention measures such as erosion control mats/blankets, mulch, hydro applications, tracking, or soil binders shall be implemented on disturbed areas within 24 hours or as soon as practical after completion of disturbance/grading or following the end of activities. Final stabilization practices shall be initiated on any site where construction activities have been suspended for more than 180 days.
- **Use low-impact/biological/recyclable materials.** To the extent possible, construction managers should utilize natural or recyclable materials as temporary measures than can remain on-site after the completion of construction. One example is using mulch berms as opposed to silt fences, which must be removed and disposed after the completion of construction activities has occurred and vegetation has become well-established. This also reduces waste and removal costs.

SEDIMENT AND EROSION CONTROL PLAN REQUIREMENTS

Erosion prevention and sediment control plans submitted to WQC must contain detailed drawings, a site description and supporting information (narrative), including the following:

1. Narrative discussion of why the utility line must be placed within 50 feet of the top of the stream bank;
2. Construction details with dimensions, cross-sectional views and plan views to scale, showing location of utility lines and all surface waters;
3. Site development plan with the proposed construction area and construction-related activities areas clearly outlined, estimated project start and end dates, project type and description of all construction activities at the site;

4. The location of all surface waters on a 7.5 Minute topographical map, including streams, wetlands, sinkholes, and stormwater discharges from the site;
5. The types, depth, slope, locations and limitations of the soils and geology, natural landscape features, drainage patterns, flooding potential, and other pertinent information that helps identify both beneficial conditions and potential problems of a site;
6. Locations of temporary and permanent erosion, sediment, and stormwater management structures; construction details with dimensions, cross-sectional views and/or plan views with enough information for the reviewer and contractor to understand how to install the practice;
7. Approximate slopes anticipated after major grading activities;
8. Areas of soil disturbance, including an outline of areas which are not to be disturbed;
9. Location and technical specifications of any bank stabilization;
10. Location and boundaries of buffer zones, if any, existing or established to protect waters of the Commonwealth located within the boundaries of the project;
11. Locations of stockpile and/or borrow areas;
12. Separate sheets for staged plans to show detail, including the clearing and grubbing phase, initial grading plan with perimeter control and the final grading plan with final erosion prevention and sediment control plans and stormwater management controls in place.

Approved plans and specifications for projects are incorporated by reference and are enforceable parts of a certification. Any changes to the approved plans or specifications require written approval by WQC. For questions or clarifications, contact the Water Quality Certification Section at (502) 564-3410

REFERENCES

Kentucky Pollutant Discharge Elimination System (KPDES) General Permit for Stormwater Discharge Associated with Construction Activities (KYR10). Locate on line at:
<http://water.ky.gov/permitting/Pages/WastewaterDischarge.aspx>

Best Management Practices (BMPs) for Controlling Erosion, Sediment, and Pollutant Runoff from Construction Sites. Planning and Technical Specifications Manual for Stormwater Pollution Prevention Plans. Revised October 2009. Technology Transfer Program, Kentucky Transportation Center, University of Kentucky.

General Certification of Nationwide Permit #12, Utility Line Backfill and Bedding, 2017. Locate on line at: <http://water.ky.gov/permitting/Pages/CertificationNationwidePermits.aspx>



United States Department of the Interior

FISH AND WILDLIFE SERVICE

Kentucky Ecological Services Field Office
330 West Broadway, Suite 265
Frankfort, Kentucky 40601
(502) 695-0468

July 2, 2018

Ms. Amy Frogue
Pennyrile Area Development District
300 Hammond Drive
Hopkinsville, KY 42240

Re: FWS 2018-B-0280; Todd County Water District and Pennyrile Rural Electric Cooperative; Construction of Basic Infrastructure for the Novelis Industries Site; Todd County, Kentucky

Dear Ms. Frogue:

The U.S. Fish and Wildlife Service (Service) has reviewed a May 29, 2018 habitat assessment and a June 22, 2018 presence/probable absence survey report for Indiana bats (*Myotis sodalis*) and northern long-eared bats (*Myotis septentrionalis*) prepared by Third Rock Consultants, LLC (Third Rock). The Service offers the following comments in accordance with the Endangered Species Act of 1973 (87 Stat. 884, as amended; 16 U.S.C. 1531 *et seq.*)

Project Description

Todd County Water District and Pennyrile Rural Electric Cooperative are in the process of seeking federal funds to install natural gas, sewer, water, and electric infrastructure to the site of the recently announced Novelis Industries site in Guthrie, Kentucky. As proposed, the federally-funded work would consist in the following:

- Todd County Water District - approximately 11,000 linear feet of 12" waterline route along US Highway 79 (north side of roadway), from KY 848 to CSX Railroad; construction of a 500,000 gallon tank on the Novelis industrial site (100x100 tank site).
- City of Guthrie - approximately 3,500 linear feet of 12" gravity sewer line route cross country from KY 346 towards the Novelis site (through trees and crossing CSX); will require railroad permit for bore
- City of Guthrie - approximately 11,600 linear feet of 6" steel natural gas line route along US Highway 79, starting at the state line on Port Royal Road to the Novelis site; will require railroad permit for bore.

- Pennyriple Rural Electric Cooperative - construction of a new substation located on an undeveloped site on KY 346 (opposite Hopkinsville Elevator) on 1-2 acre lot; power lines will be overhead across the road to the Novelis site.

Indiana Bat (*Myotis sodalis*)

Northern Long-eared Bat (*Myotis septentrionalis*)

The proposed project is located in “potential” habitat for the Indiana bat and the northern long-eared bat. These species winter in caves, rock shelters, and abandoned underground mines. During the summer they roosts in trees, which usually have, cracks, crevices, broken tops, broken limbs, or sloughing bark, and forage in and around forested habitat.

The May 29, 2018 habitat assessment states that no cave or cave-like habitat is present within the project area; however, the proposed project will result in the removal of suitable habitat along 0.5 mile of sewer line. The June 22, 2018 presence/probable absence survey report prepared by Rain Storm, a Third Rock senior ecologist, stated that no federally-listed bats were captured over the survey period. Based on the information available, Indiana bats and northern long-eared bats are likely absent from the project area. Therefore, the Service would concur with a “may affect – not likely to adversely affect” determination for these species.

Gray Bat (*Myotis grisescens*)

Gray bats roost, breed, rear young, and hibernate in caves or cave-like features year round and forage on a variety of flying aquatic and terrestrial insects present along streams, rivers, and lakes. According to the habitat assessment conducted by Third Rock, no cave or cave-like habitat exists within the project area of this project. In addition, impacts to this species due to the loss of foraging habitat will be insignificant (i.e., impact would not reach the scale where take occurs) because riparian corridors containing additional suitable foraging habitat exist nearby.

Based on the information available, direct effect to the species will be avoided due to the lack of roosting habitat. In addition, indirect effects resulting from the loss of foraging habitat will be insignificant. Therefore, the Service would concur with a “may affect – not likely to adversely affect” determination for the gray bat.

The comments provided on this letter are based on the current information available to us. The Service’s comments or concerns might change, however, if: (1) new information reveals that the proposed action may affect listed species in a manner or to an extent not previously considered, (2) the proposed action is subsequently modified to include activities which were not considered during this consultation, or (3) new species are listed or critical habitat designated before the project is completed.

Ms. Amy Frogue

3

Thank you again for your request. Your concern for the protection of endangered and threatened species is greatly appreciated. If you have any questions regarding the information that we have provided, please contact Santiago Martín at (502) 695-0468 extension 116 or santiago_martin@fws.gov.

Sincerely,

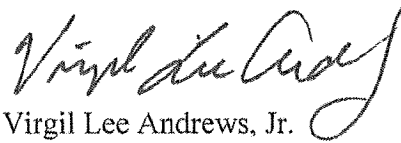
A handwritten signature in cursive script that reads "Virgil Lee Andrews, Jr." The signature is written in black ink and is positioned above the printed name and title.

Virgil Lee Andrews, Jr.
Field Supervisor

cc: Ms. Molly C. Foree, Third Rock Consultants, LLC (electronic)
Mr. Chris Wilcutt, McGhee Engineering (electronic)



MATTHEW G. BEVIN
GOVERNOR

**TOURISM, ARTS AND HERITAGE CABINET
KENTUCKY HERITAGE COUNCIL
THE STATE HISTORIC PRESERVATION OFFICE**

REGINA STIVERS
DEPUTY SECRETARY

DON PARKINSON
SECRETARY

410 HIGH STREET
FRANKFORT, KENTUCKY 40601
PHONE (502) 564-7005
FAX (502) 564-5820
www.heritage.ky.gov

CRAIG A. POTTS
EXECUTIVE DIRECTOR
& STATE HISTORIC
PRESERVATION OFFICER

October 18, 2018

Mr. Lee Foster
Principal Investigator
Pennyrile Archaeological Services, LLC
526 Beechwood Drive
Cadiz, KY 42211

Re: Phase I Archaeological Survey of Proposed Utility Improvements for the Novelis Facility in and near Guthrie, Todd County, Kentucky, prepared by Lee Foster of Pennyrile Archaeological Services. Report dated September 17, 2018.

Dear Ms. Foster:

Thank you for your letter and enclosed report concerning the above-mentioned project, received September 19, 2018. The report describes the archaeological survey of utility lines and the location of a proposed water tower for the Novelis facility, Guthrie, Todd County, Kentucky.

The archeological survey consisted of intensive pedestrian survey supplemented by screened shovel probes. During the survey, the investigator identified three archaeological sites, and revisited a historic cemetery adjacent to US Highway 79. Sites 15To80, 15To81, and 15To82 are prehistoric sites, producing stone tool manufacturing remains. The investigator recovered no temporally diagnostic artifacts at these three sites, and encountered no evidence of intact subsurface deposits. The sites may extend beyond the boundaries of the current survey area. Based on these results, the investigator recommended no additional work at these sites, and recommended that the sites were not eligible for the National Register of Historic Places.

Additionally, the investigator recorded a historic cemetery – the Tyler Cemetery – as an above-ground resource (TO-63). The cemetery was recorded by a local historian in the 1970's. The revisit identified all of the graves identified by the local historian. The cemetery is situated adjacent to, but outside, of the current project area. It will be avoided during the proposed utility installation.

After review of the report, we agree with the report's findings. With regards to the archaeological site, we do not agree that the sites are not eligible for the National Register. The boundaries of these sites likely extend beyond the project area, and were likely not to have been fully defined in the current work. Therefore, we do not have sufficient evidence at this point to determine their eligibility for the National Register. However, we do agree that the portions of the sites contained within the current project do not contain deposits significant under National Register Criterion D.

The cemetery's eligibility for listing on the National Register was not assessed, and we will withhold comment on its eligibility at this point. We would recommend that temporary protective fencing is erected at the edge of the Tyler Cemetery during construction activities to ensure avoidance.

In consideration of the report's findings, we would recommend that the proposed utility work will result in **No Effect to Historic Properties**. We accept this report as final and acknowledge receipt of three archival copies.

L. Foster
Pennyrite Archaeological Services
Novelis Plant Utility Project
October 18, 2018
page 2

If the project design or boundaries change, this office should be consulted to determine the nature and extent of additional documentation that may be needed. In the event of the unanticipated discovery of an archaeological site or object of antiquity, the discovery should be reported to the Kentucky Heritage Council and to the Kentucky Office of State Archaeology in the Anthropology Department at the University of Kentucky in accordance with KRS 164.730. In the event that human remains are encountered during project activities, all work should be immediately stopped in the area and the area cordoned off, and in accordance with KRS 72.020 the county coroner and local law enforcement must be contacted immediately. Upon confirmation that the human remains are not of forensic interest, the unanticipated discovery must be reported to the Kentucky Heritage Council.

Should you have any questions concerning archaeological resources, feel free to contact Chris Gunn of my staff at (502) 892-3615 or chris.gunn@ky.gov. Questions concerning above-ground resources can be directed to Jennifer Ryall at (502) 892-3619 or jennifer.ryall@ky.gov.

Sincerely,



Craig A. Potts,
Executive Director and
State Historic Preservation Officer

CP: cmg KHC # 52429
cc: George Crothers (OSA); Gabe Nickell (DLG)

CONSTRUCTION PLANS

for the

NOVELIS SANITARY SEWER EXTENSION PROJECT

Contract #1 - Sewer Line Extension
by the

City of Guthrie, Kentucky

Todd County, Kentucky

VICINITY MAP

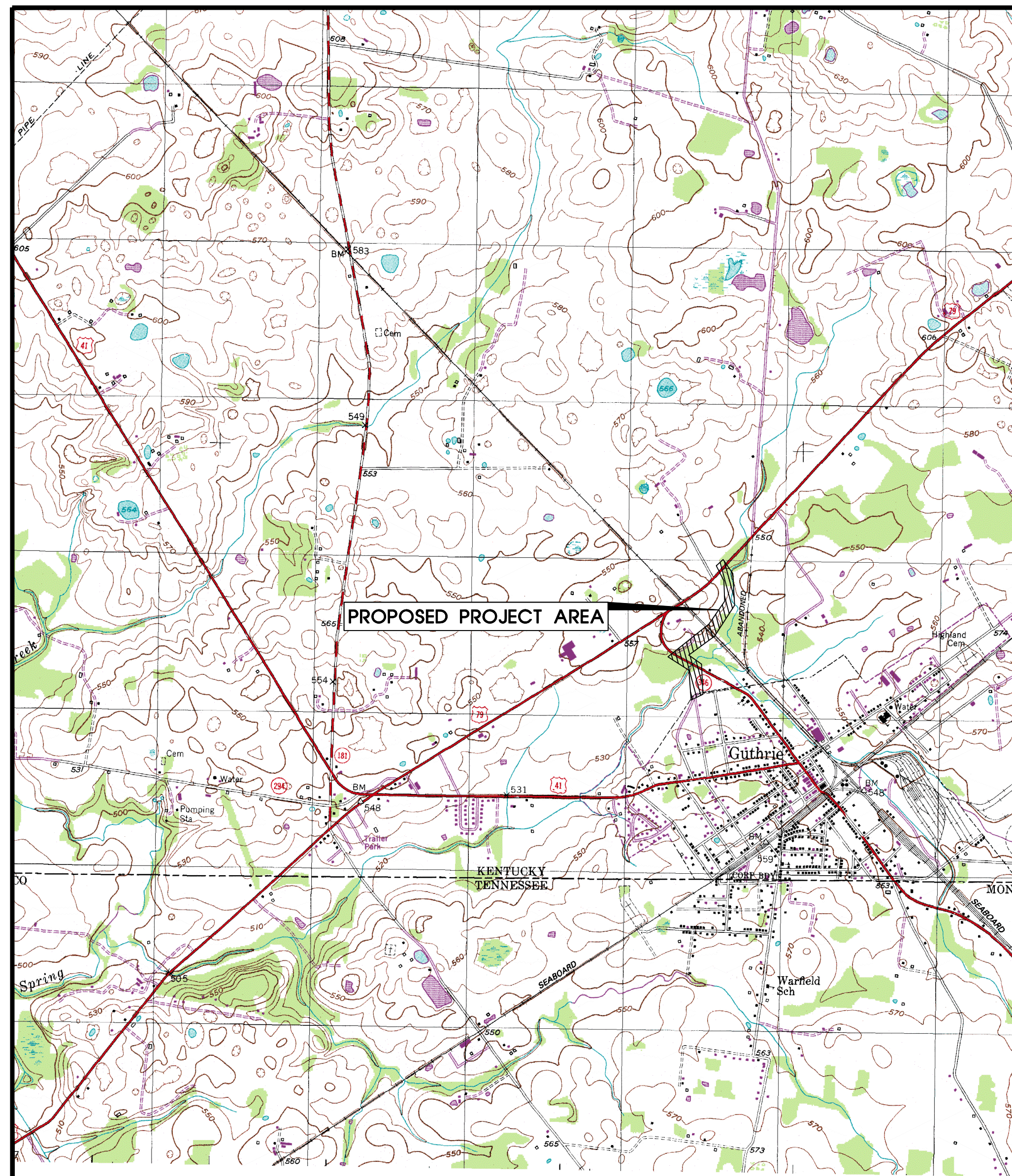

SHEET INDEX

Mayor & City Council

Scott Marshall
Pam Turner
Norma Williams
Mary Charles King
Teri Tilghman-Douglas
Harry Green
Jimmy Covington

Mayor
Councilmember
Councilmember
Councilmember
Councilmember
Councilmember

Guthrie, Kentucky
P.O. Box 125
Guthrie, Kentucky 42234
(270) 483-2511

Engineer

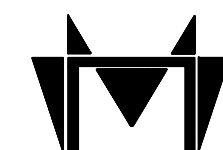

McGhee Engineering, Inc.
202 Ewing St, Box 267
Guthrie, Kentucky 42234
(270) 483-9985

| No | Revision | Date | By |
|----|-----------------|----------|-----|
| 1 | FOR KDOV REVIEW | 08-16-18 | CWW |

REVISIONS

August 2018

PROJECT INFORMATION

T-1 Title Sheet

SEWER LINE PLAN

- P-1 Gravity Sewer Main Plan: Existing Manhole to New Manhole 5
- P-2 Gravity Sewer Main Plan: New Manhole 5 to New Manhole 9
- P-3 Gravity Sewer Main Plan: New Manhole 9 to New Manhole 11

SEWER LINE DETAILS

- D-1 Standard Sewer Details
- D-2 Standard Sewer Details

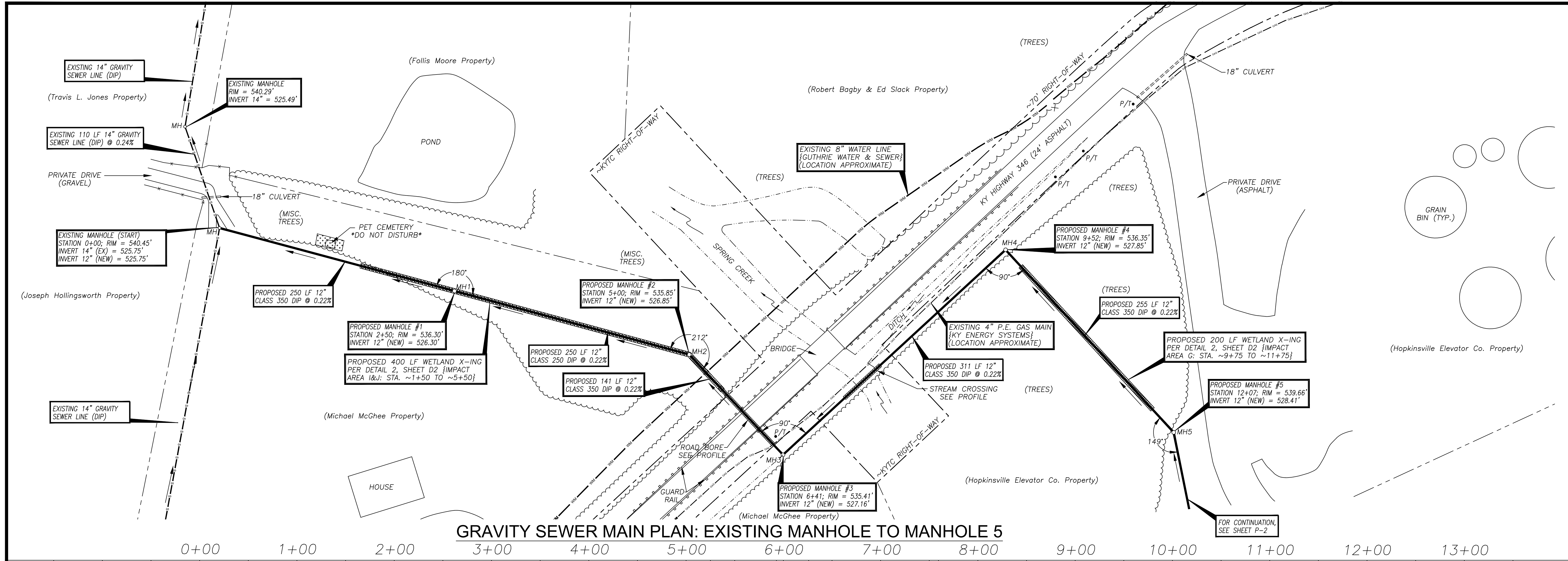

GRAVITY SEWER MAIN PLAN: EXISTING MANHOLE TO MANHOLE 5

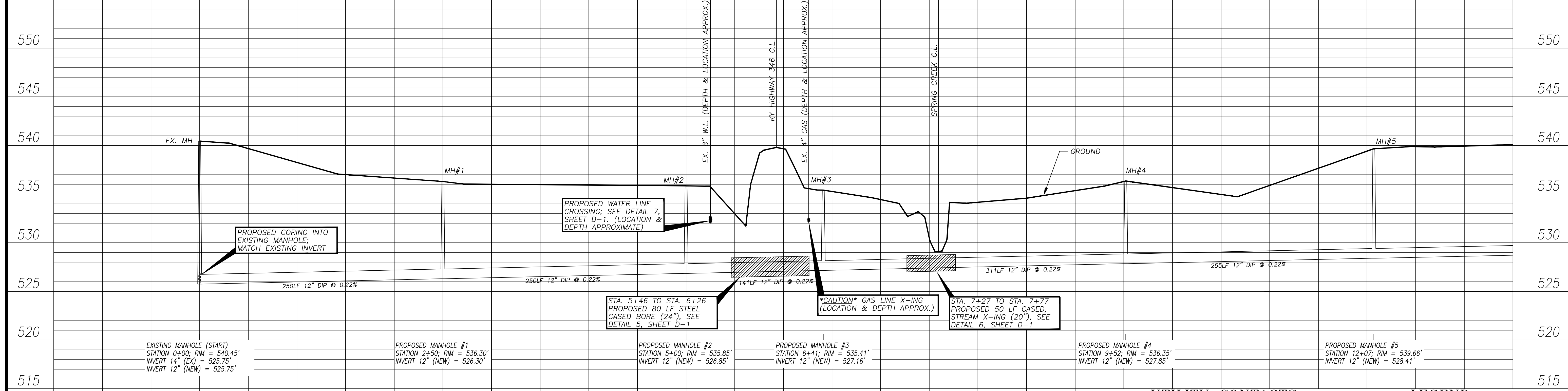

ENVIRONMENTAL NOTE:
 THE CONTRACTOR SHALL BE RESPONSIBLE FOR CUTTING, REMOVING AND DISPOSING OF TREES, BRUSH, STUMPS, ROOTS, AND WEEDS WITHIN THE CONSTRUCTION AREA AS REQUIRED FOR CONSTRUCTION OF THE PIPELINE. AVOID CUTTING OF OR DAMAGE TO MATURE TREES (DBH>5") AND TREES NOT IN THE CONSTRUCTION AREA. THE CONTRACTOR WILL BE RESPONSIBLE FOR THE REPLACEMENT OF TREES, SHRUBS, ETC. UNNECESSARILY DAMAGED OR REMOVED. IF BAT OR OTHER ENDANGERED SPECIES ARE ENCOUNTERED, PROMPTLY CONTACT USF&W.

BASEMAP & SCALE NOTE:
 THE LOCATIONS OF EXISTING TOPOGRAPHIC FEATURES AND UTILITIES ARE APPROXIMATE. THE CONTRACTOR SHALL FAMILIARIZE HIMSELF WITH THE PROJECT SITE PRIOR TO CONSTRUCTION. UNDER NO CIRCUMSTANCES SHALL THE CONTRACTOR ASSUME THAT ALL FEATURES ARE IDENTIFIED AND INDICATED IN THEIR EXACT LOCATION. THE CONTRACTOR SHALL CONTACT KENTUCKY UNDERGROUND PROTECTION, INC., AS WELL AS OTHER UTILITIES, PIPELINE COMPANIES, ETC. POTENTIALLY HAVING UNDERGROUND LINES, UTILITIES, STRUCTURES, ETC.. IN THE AREA FOR VERIFICATION AND LOCATION PRIOR TO EXCAVATION.

UTILITY CONTACTS

| | |
|--------------------------------------|----------------|
| Ky. Underground Protection | (800) 752-6007 |
| South Central Bell | (800) 752-6007 |
| Pennyrile Rural Electric Coop. | (800) 265-2545 |
| Texas Gas Pipeline | (800) 626-1948 |
| Kentucky Energy Systems | (931) 624-3677 |
| KDOT Division #3: Bowling Green | (270) 746-7898 |
| Todd County Road Department | (270) 265-5262 |
| City of Guthrie | (270) 483-2511 |
| Logan Todd Regional Water Commission | (270) 483-6990 |

LEGEND

| | |
|-----------------------------|---------------------|
| PROPOSED SEWER MAIN | —●—●—●—●—●—●— |
| EXISTING SEWER LINE | —S—S—S—S—S—S— |
| EXISTING GUTHRIE WATER LINE | —W—W—W—W—W—W— |
| PROPOSED TCWD WATER LINE | —TW—TW—TW—TW—TW—TW— |
| PROPERTY LINE | —Dashed Line— |
| GAS LINE | —G—G—G—G—G—G— |
| RESIDENTIAL METER | ⊞ |
| PHONE PEDESTAL | ⊞ |
| POLE GUY WIRE | σ |
| POWER/TELEPHONE POLE | ● P/T |
| GAS METER/REGULATOR | ⊞ |

August 16, 2018

SCALE:
 1" = 50' (H)
 1" = 5' (V)

Chris Wilcott
 Chris Wilcott, P.E.

| NO. | REVISIONS | DATE |
|-----|-----------|------|
| | | |

FOR ROW REVIEW 08-16-18

FIRM: McGhee Engineering
 DES BY: CWW CHK BY: MWW
 DWN BY: CWW APP BY:
 SCALE: AS SHOWN
 PROJECT DATE: 2018
 PRINTED: _____

LENGTH OF BAR IS 1" ON ORIGINAL DRAWING

City of Guthrie, Kentucky
NOVELIS SANITARY SEWER
EXTENSION PROJECT
 Contract 1 - Sewer Line Extension
 Sewer Line Plan & Profile

MCGHEE ENGINEERING
 202 Ewing Street
 Guthrie, KY 42234
 (270) 483-9985

Guthrie
GUTHRIE WATER & SEWER
 P.O. Box 125
 Guthrie, KY 42234
 (270) 483-2511

DRAWING NO. _____

SHEET P-1

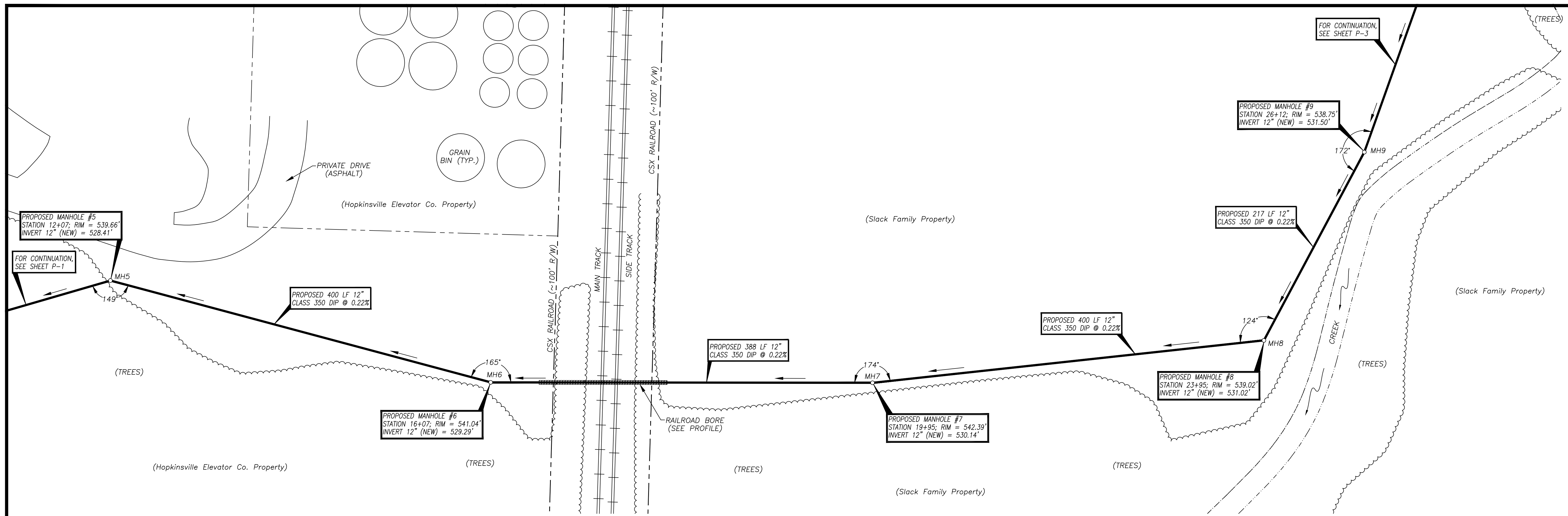

GRAVITY SEWER MAIN PLAN: MANHOLE 5 TO MANHOLE 9

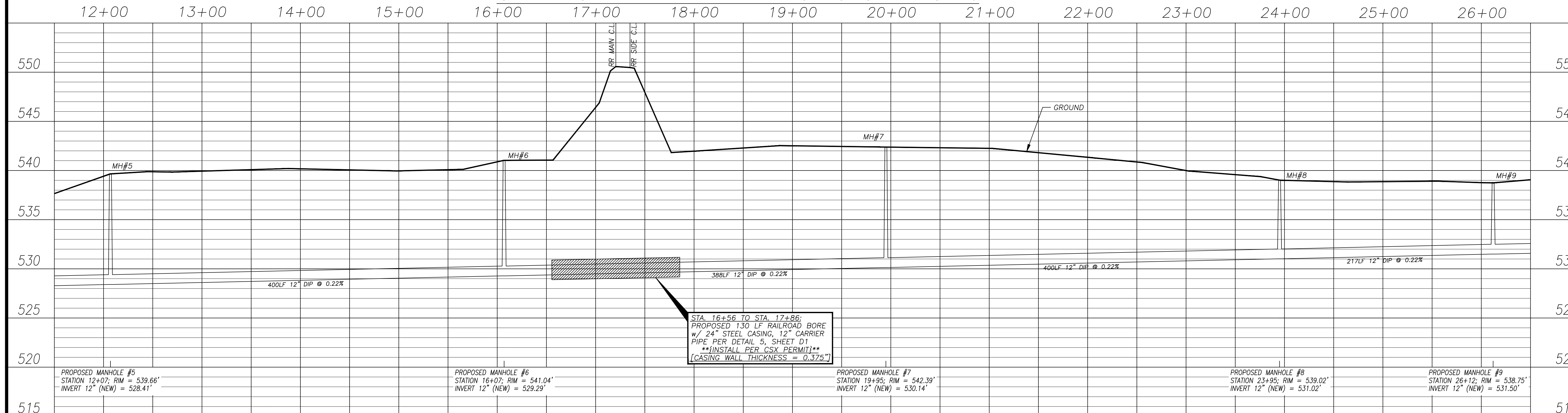

ENVIRONMENTAL NOTE:
 THE CONTRACTOR SHALL BE RESPONSIBLE FOR CUTTING, REMOVING AND DISPOSING OF TREES, BRUSH, STUMPS, ROOTS, AND WEEDS WITHIN THE CONSTRUCTION AREA AS REQUIRED FOR CONSTRUCTION OF THE PIPELINE. AVOID CUTTING OF OR DAMAGE TO MATURE TREES (DBH>5"), AND TREES NOT IN THE CONSTRUCTION AREA. THE CONTRACTOR WILL BE RESPONSIBLE FOR THE REPLACEMENT OF TREES, SHRUBS, ETC. UNNECESSARILY DAMAGED OR REMOVED. IF BAT OR OTHER ENDANGERED SPECIES ARE ENCOUNTERED, PROMPTLY CONTACT USF&W.

BASEMAP & SCALE NOTE:
 THE LOCATIONS OF EXISTING TOPOGRAPHIC FEATURES AND UTILITIES ARE APPROXIMATE. THE CONTRACTOR SHALL FAMILIARIZE HIMSELF WITH THE PROJECT SITE PRIOR TO CONSTRUCTION. UNDER NO CIRCUMSTANCES SHALL THE CONTRACTOR ASSUME THAT ALL FEATURES ARE IDENTIFIED AND INDICATED IN THEIR EXACT LOCATION. THE CONTRACTOR SHALL CONTACT KENTUCKY UNDERGROUND PROTECTION, INC., AS WELL AS OTHER UTILITIES, PIPELINE COMPANIES, ETC. POTENTIALLY HAVING UNDERGROUND LINES, UTILITIES, STRUCTURES, ETC.. IN THE AREA FOR VERIFICATION AND LOCATION PRIOR TO EXCAVATION.

UTILITY CONTACTS

| | |
|--------------------------------------|----------------|
| Ky. Underground Protection | (800) 752-6007 |
| South Central Bell | (800) 752-6007 |
| Pennyrile Rural Electric Coop. | (800) 265-2545 |
| Texas Gas Pipeline | (800) 626-1948 |
| Kentucky Energy Systems | (931) 624-3677 |
| KDOT Division #3: Bowling Green | (270) 746-7898 |
| Todd County Road Department | (270) 265-5262 |
| City of Guthrie | (270) 483-2511 |
| Logan Todd Regional Water Commission | (270) 483-6990 |

LEGEND

| | |
|-----------------------------|--|
| PROPOSED SEWER MAIN | |
| EXISTING SEWER LINE | |
| EXISTING GUTHRIE WATER LINE | |
| PROPOSED TCWD WATER LINE | |
| PROPERTY LINE | |
| GAS LINE | |
| RESIDENTIAL METER | |
| PHONE PEDESTAL | |
| POLE GUY WIRE | |
| POWER/TELEPHONE POLE | |
| GAS METER/REGULATOR | |

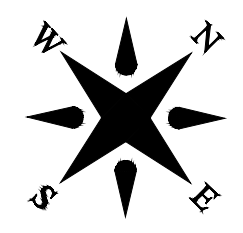

SCALE:
 1" = 50' (H)
 1" = 5' (V)

August 16, 2018



Chris Wilcott, P.E.

| | | |
|-----|-------|----------------|
| NO. | DATE: | FOR ROW REVIEW |
| | | |
| | | |
| | | |
| | | |
| | | |
| | | |
| | | |
| | | |
| | | |
| | | |

FIRM: McGhee Engineering
 DES BY: CWW CHK BY: MWW
 DWN BY: CWW APP BY:
 SCALE: AS SHOWN
 PROJECT DATE: 2018
 PRINTED: LENGTH OF BAR IS 1" ON ORIGINAL DRAWING

City of Guthrie, Kentucky
NOVELIS SANITARY SEWER
EXTENSION PROJECT
 Contract 1 - Sewer Line Extension
 Sewer Line Plan & Profile

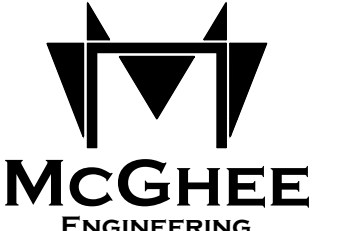

MCGHEE
ENGINEERING

202 Ewing Street
 Guthrie, KY 42234
 (270) 483-9985



GUTHRIE
WATER & SEWER

P.O. Box 125
 Guthrie, KY 42234
 (270) 483-2511

DRAWING NO. SHEET P-2

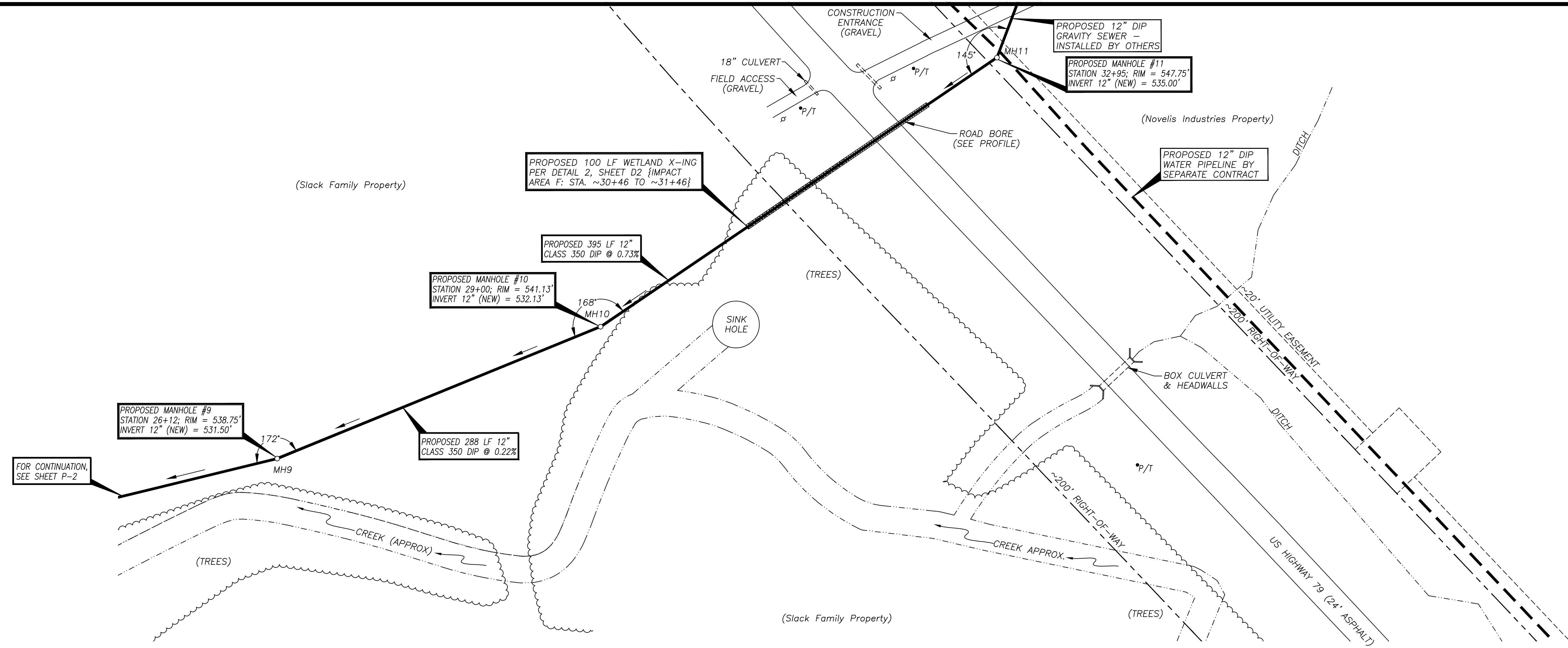

GRAVITY SEWER MAIN PLAN: MANHOLE 9 TO MANHOLE 11

25+00 26+00 27+00 28+00 29+00 30+00 31+00 32+00 33+00 34+00 35+00 36+00 37+00 38+00

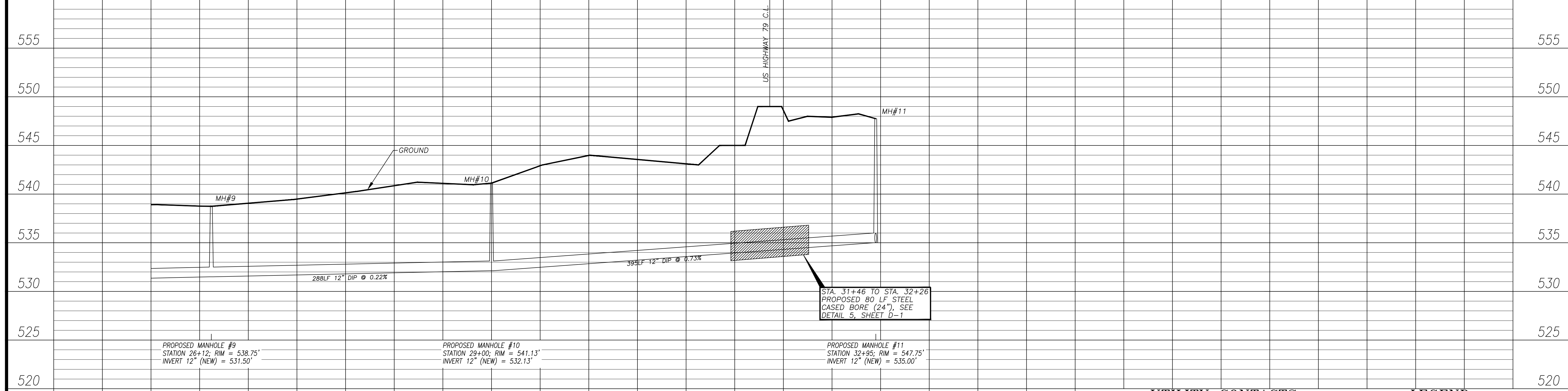

ENVIRONMENTAL NOTE:
 THE CONTRACTOR SHALL BE RESPONSIBLE FOR CUTTING, REMOVING AND DISPOSING OF TREES, BRUSH, STUMPS, ROOTS, AND WEEDS WITHIN THE CONSTRUCTION AREA AS REQUIRED FOR CONSTRUCTION OF THE PIPELINE. AVOID CUTTING OF OR DAMAGE TO MATURE TREES (DBH>5"), AND TREES NOT IN THE CONSTRUCTION AREA. THE CONTRACTOR WILL BE RESPONSIBLE FOR THE REPLACEMENT OF TREES, SHRUBS, ETC. UNNECESSARILY DAMAGED OR REMOVED. IF BAT OR OTHER ENDANGERED SPECIES ARE ENCOUNTERED, PROMPTLY CONTACT USF&W.

BASEMAP & SCALE NOTE:
 THE LOCATIONS OF EXISTING TOPOGRAPHIC FEATURES AND UTILITIES ARE APPROXIMATE. THE CONTRACTOR SHALL FAMILIARIZE HIMSELF WITH THE PROJECT SITE PRIOR TO CONSTRUCTION. UNDER NO CIRCUMSTANCES SHALL THE CONTRACTOR ASSUME THAT ALL FEATURES ARE IDENTIFIED AND INDICATED IN THEIR EXACT LOCATION. THE CONTRACTOR SHALL CONTACT KENTUCKY UNDERGROUND PROTECTION, INC., AS WELL AS OTHER UTILITIES, PIPELINE COMPANIES, ETC. POTENTIALLY HAVING UNDERGROUND LINES, UTILITIES, STRUCTURES, ETC.. IN THE AREA FOR VERIFICATION AND LOCATION PRIOR TO EXCAVATION.

| UTILITY CONTACTS | | LEGEND | |
|--------------------------------------|----------------|-----------------------------|---------------------|
| Ky. Underground Protection | (800) 752-6007 | PROPOSED SEWER MAIN | —●—●—●—●—●—●— |
| South Central Bell | (800) 752-6007 | EXISTING SEWER LINE | —S—S—S—S—S—S— |
| Pennyrile Rural Electric Coop. | (800) 265-2545 | EXISTING GUTHRIE WATER LINE | —W—W—W—W—W—W— |
| Texas Gas Pipeline | (800) 626-1948 | PROPOSED TCWD WATER LINE | —TW—TW—TW—TW—TW—TW— |
| Kentucky Energy Systems | (931) 624-3677 | PROPERTY LINE | —P—P—P—P—P—P— |
| KDOT Division #3: Bowling Green | (270) 746-7898 | GAS LINE | —G—G—G—G—G—G— |
| Todd County Road Department | (270) 265-5262 | RESIDENTIAL METER | ⊞ |
| City of Guthrie | (270) 483-2511 | PHONE PEDESTAL | ⊞ |
| Logan Todd Regional Water Commission | (270) 483-6990 | POLE GUY WIRE | σ |
| | | POWER/TELEPHONE POLE | ● P/T |
| | | GAS METER/REGULATOR | ⊞ |

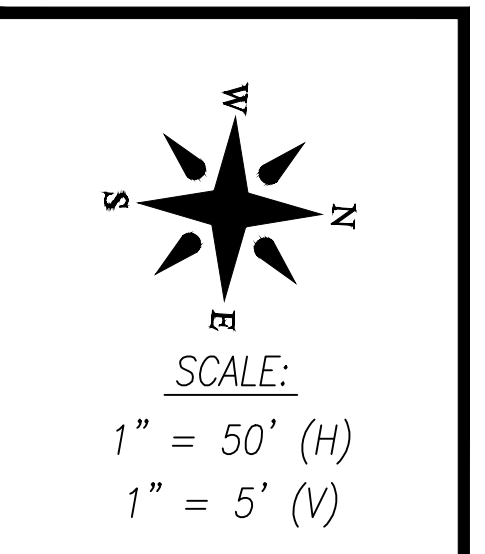

August 16, 2018
 Chris Wilcutt, P.E.
 Chris Wilcutt, P.E.

| NO. | REVISIONS | DATE: |
|-----|--|----------|
| 1 | REVISED US HWY 78 X-ING FOR ROW REVIEW | 12-31-18 |
| 2 | FOR ROW REVIEW | 08-16-18 |

FIRM: McGhee Engineering
 DES BY: CWW CHK BY: MWW
 DWN BY: CWW APP BY:
 SCALE: AS SHOWN
 PROJECT DATE: 2018
 PRINTED:
 LENGTH OF BAR IS 1" ON ORIGINAL DRAWING

City of Guthrie, Kentucky
NOVELIS SANITARY SEWER
EXTENSION PROJECT
 Contract 1 - Sewer Line Extension
 Sewer Line Plan & Profile

MCGHEE ENGINEERING
 202 Ewing Street
 Guthrie, KY 42234
 (270) 483-9985

Guthrie WATER & SEWER
 P.O. Box 125
 Guthrie, KY 42234
 (270) 483-2511

DRAWING NO.
 SHEET P-3

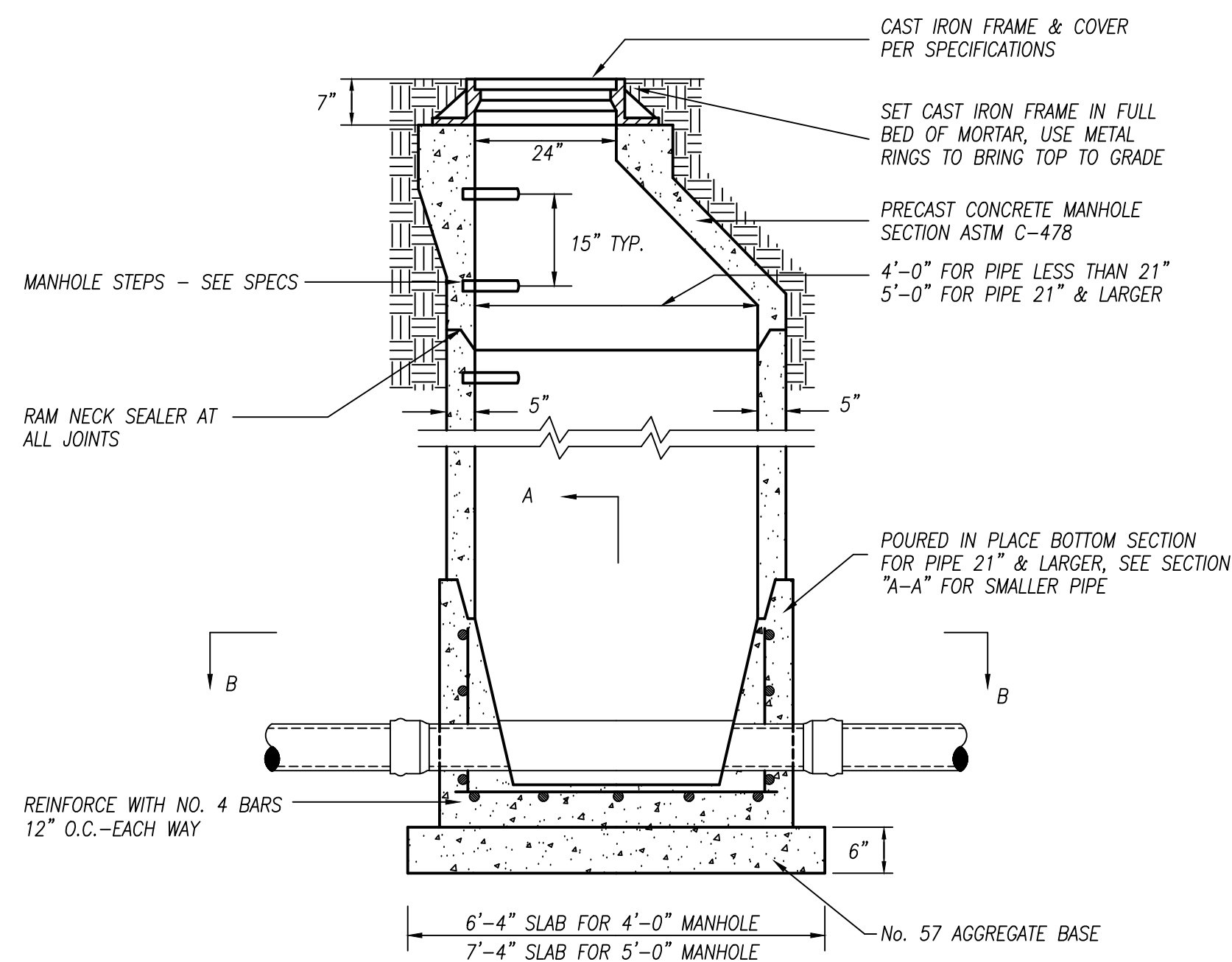

- NOTES:
1. THIS SECTION ALSO TYPICAL FOR DEVELOPED PRECAST BASE.
 2. SEE DETAIL 2, THIS SHEET FOR REFERENCED SECTIONS.

TYPICAL MANHOLE

NOT TO SCALE

1
D1

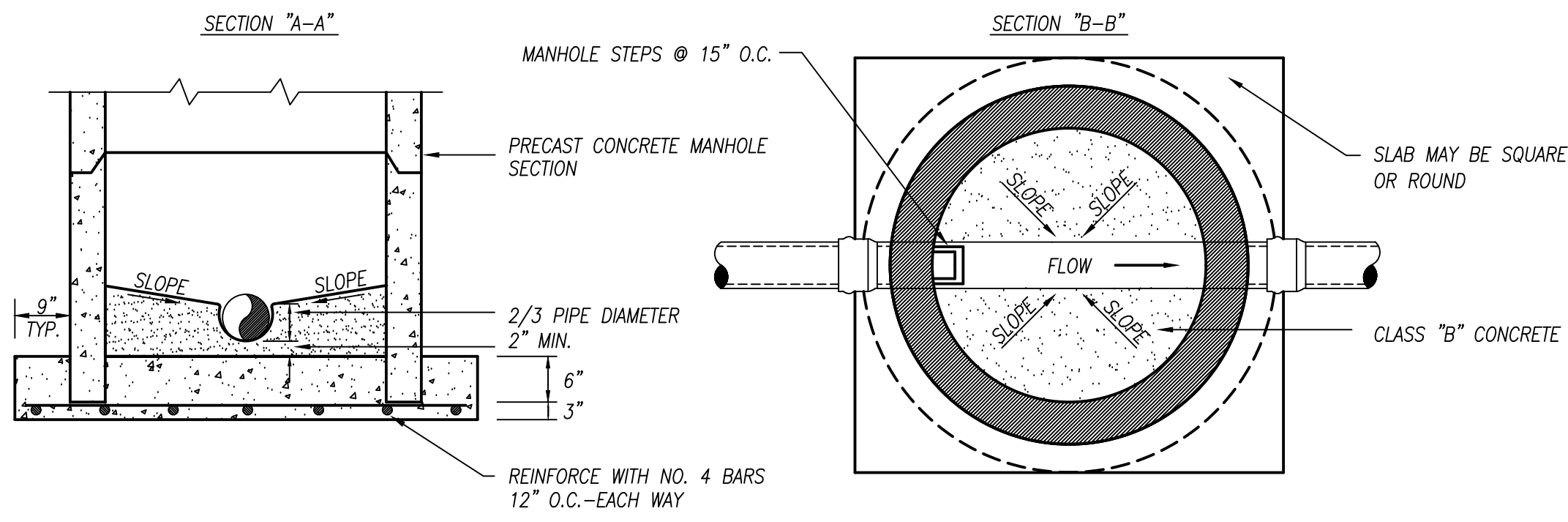

TYPICAL MANHOLE SECTIONS

NOT TO SCALE

2
D1

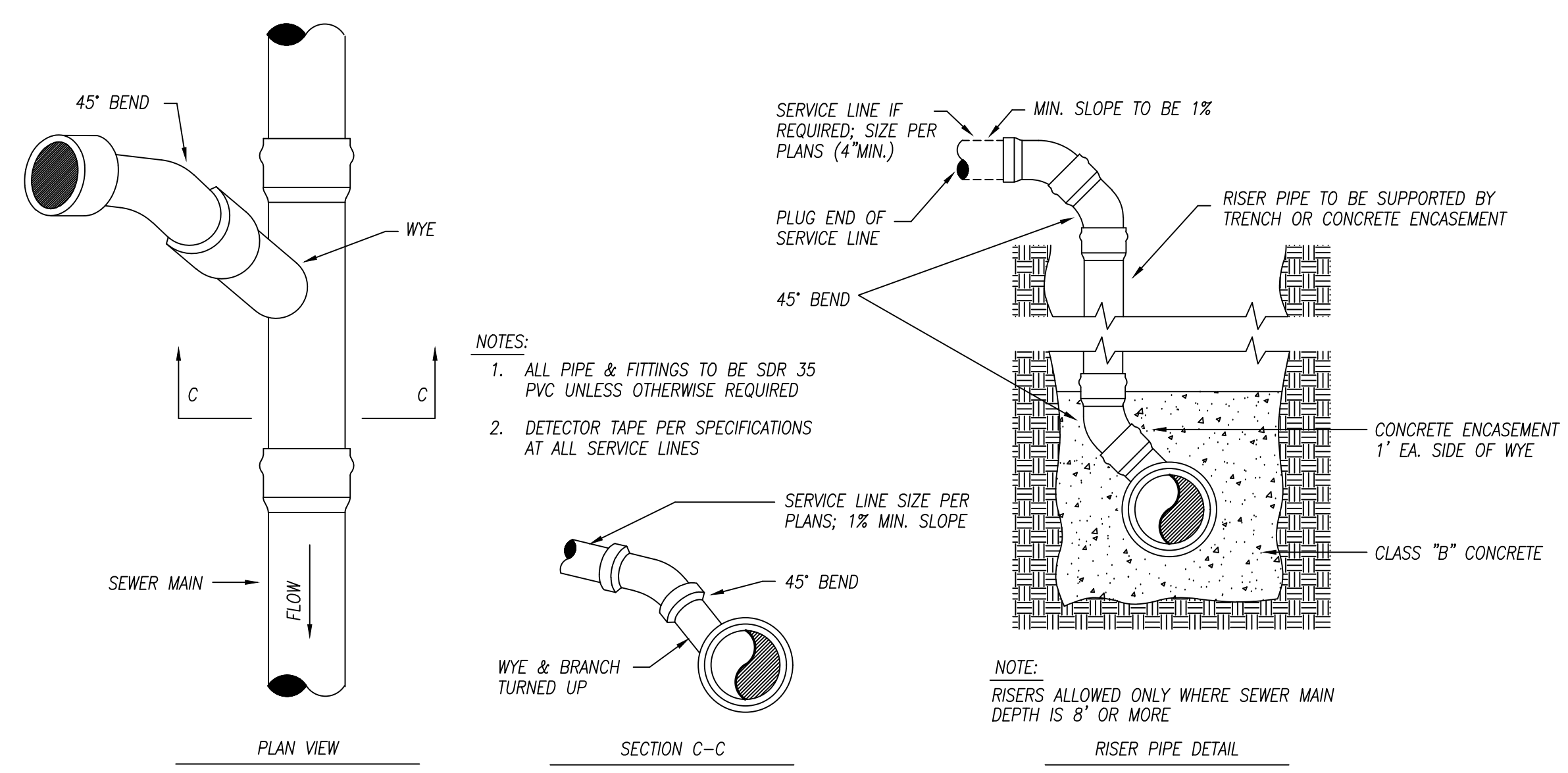

- NOTES:
1. ALL PIPE & FITTINGS TO BE SDR 35 PVC UNLESS OTHERWISE REQUIRED
 2. DETECTOR TAPE PER SPECIFICATIONS AT ALL SERVICE LINES

NOTE: RISERS ALLOWED ONLY WHERE SEWER MAIN DEPTH IS 8' OR MORE

SERVICE CONNECTION: OPEN CUT OR BORED

NOT TO SCALE

3
D1

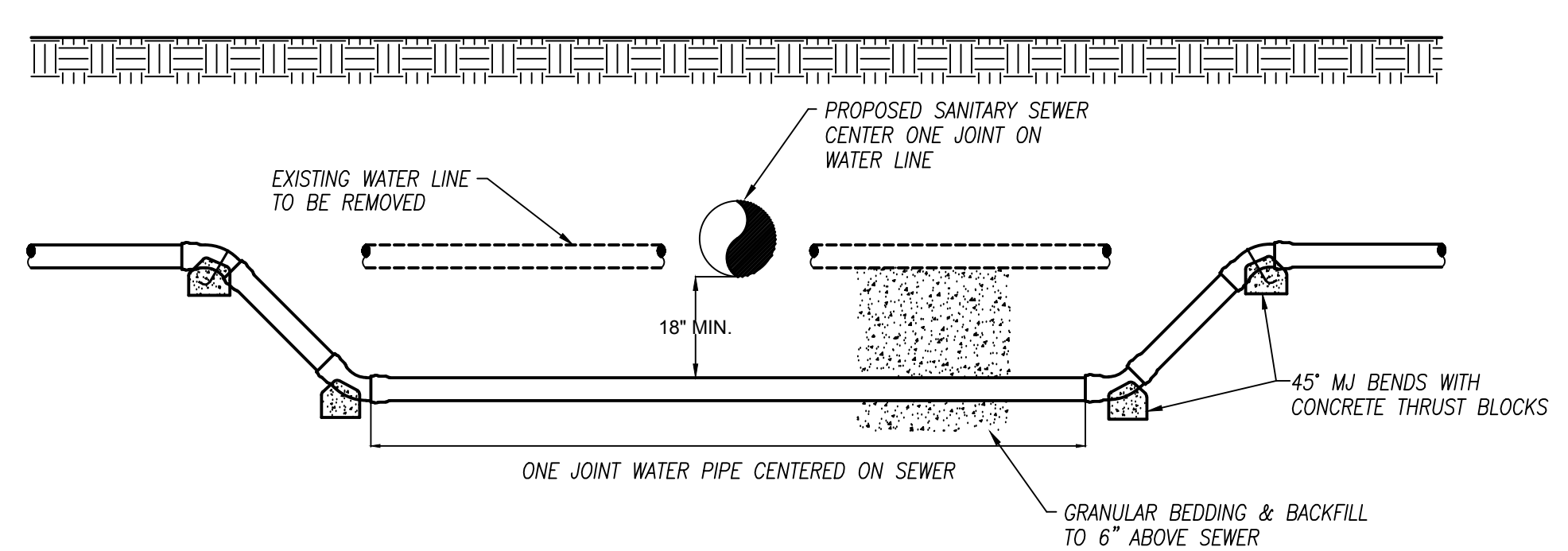

WATER LINE LOWERING NEW SEWER CROSSING

NOT TO SCALE

4
D1

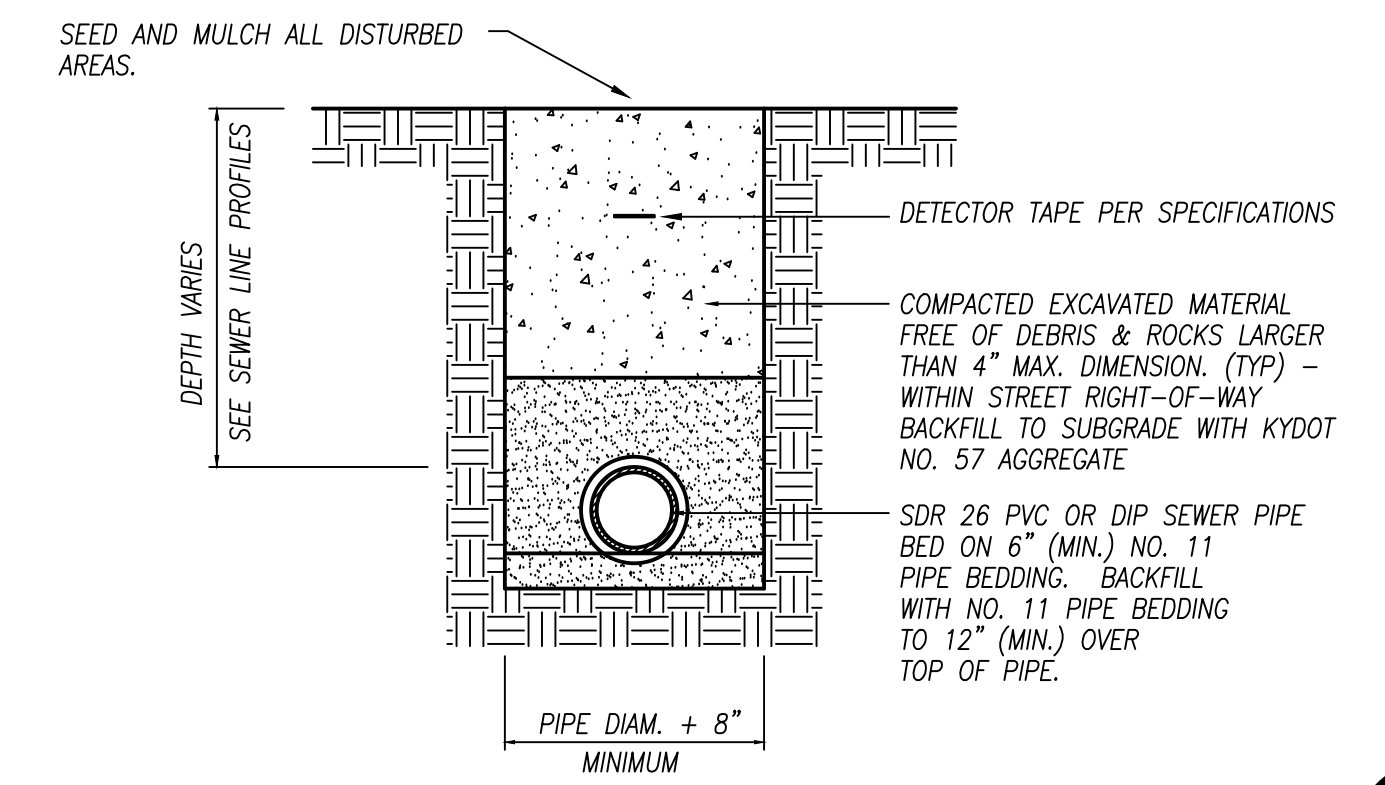

SEWER MAIN BEDDING & BACKFILL

NOT TO SCALE

8
D1

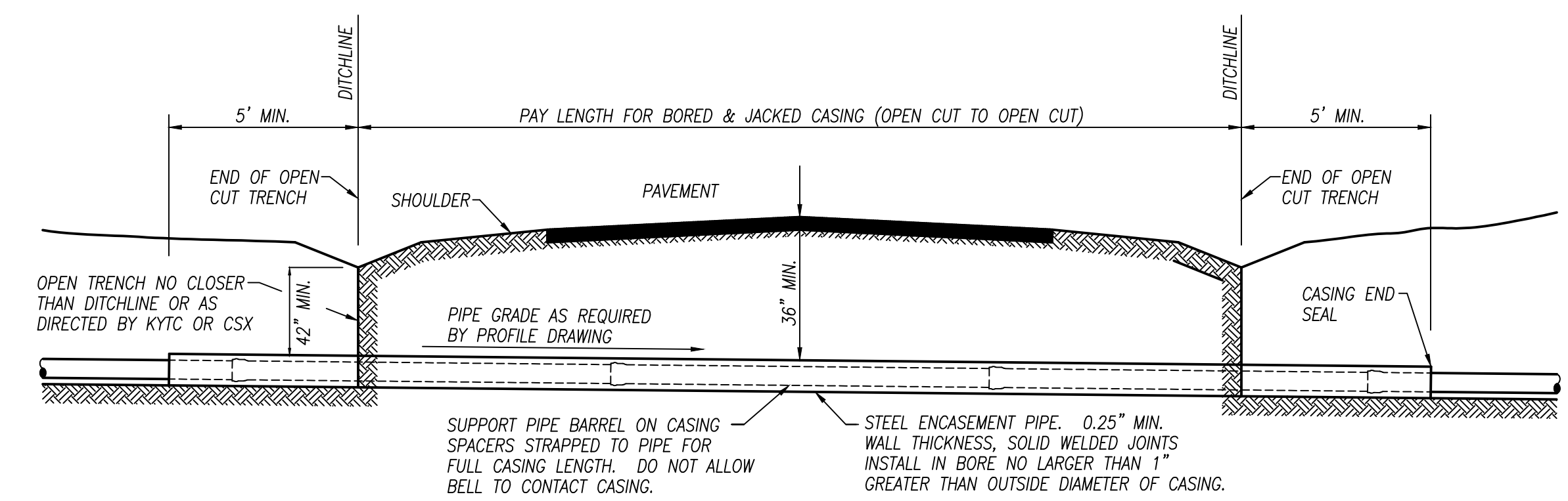

STEEL CASED ROAD BORE-SEWER

NOT TO SCALE

5
D1

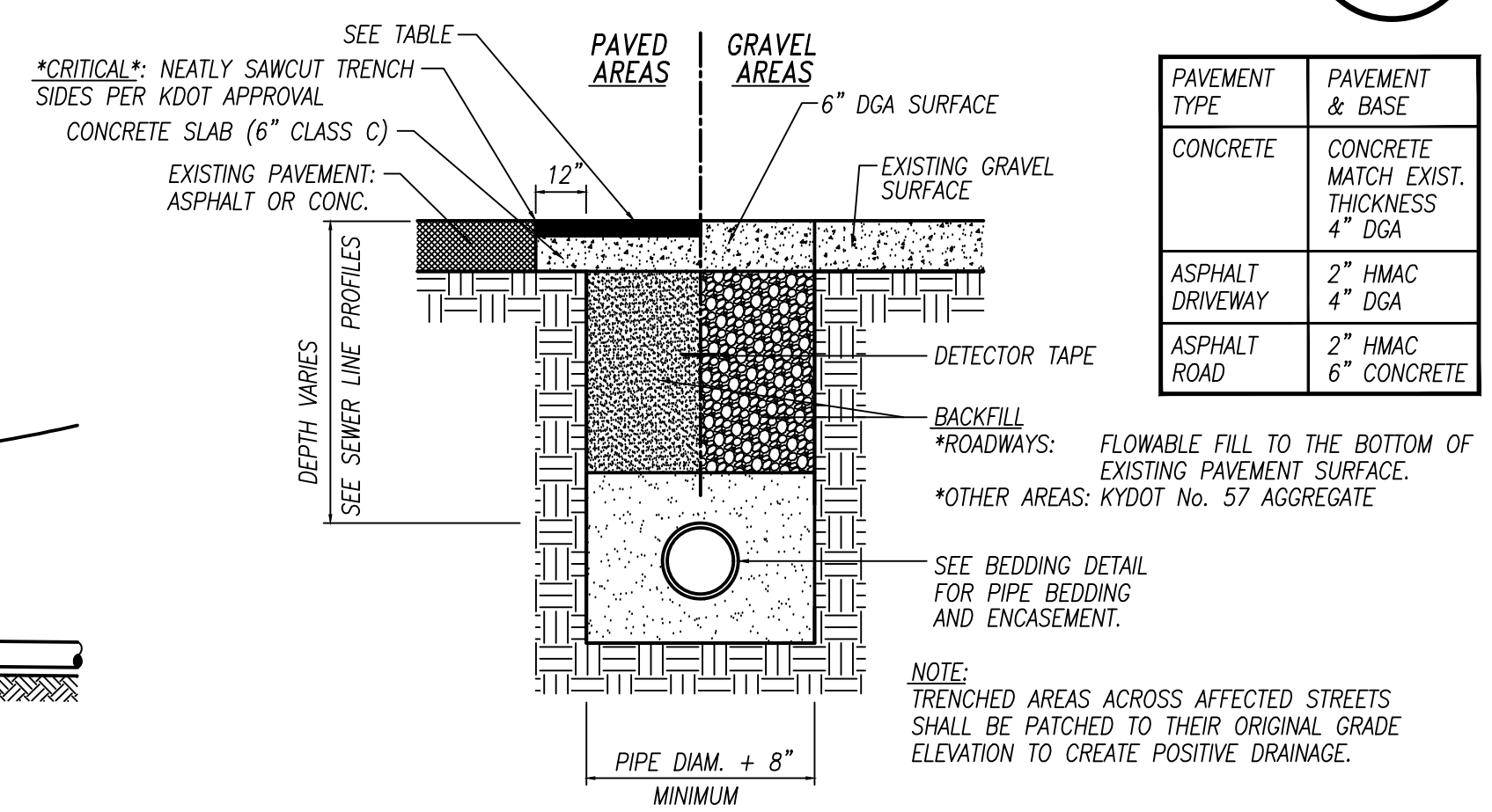

PAVEMENT REPAIR/REPLACEMENT (SEWER)

NOT TO SCALE

9
D1

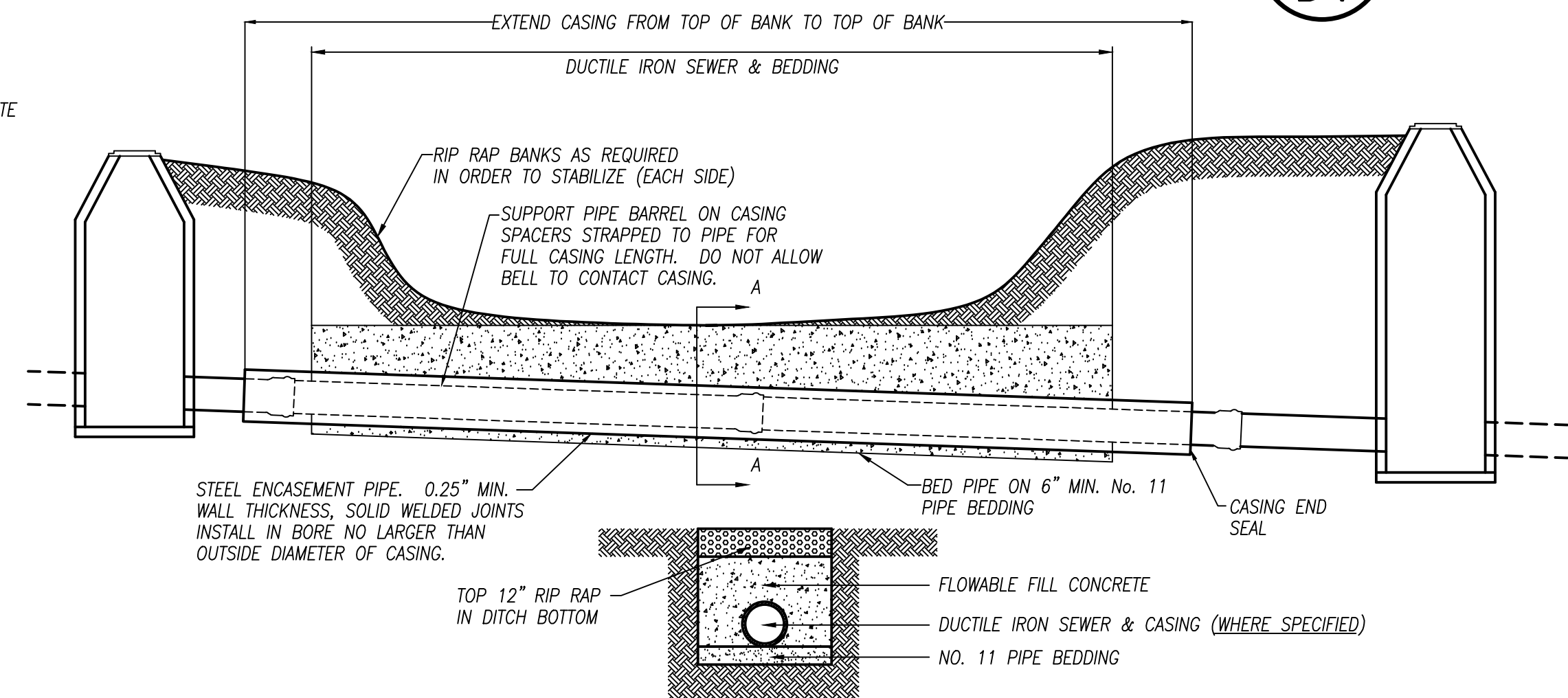

WIDE STREAM CROSSING

NOT TO SCALE

6
D1

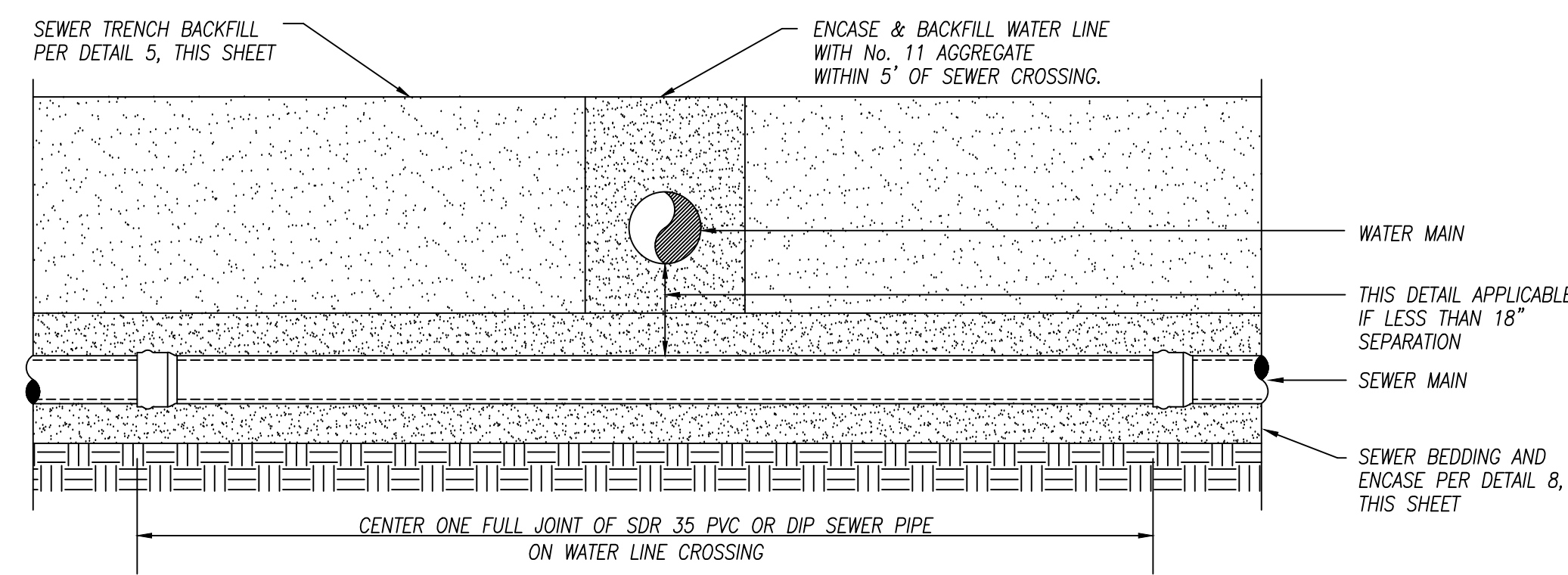

WATER LINE CROSSING

NOT TO SCALE

7
D1



| NO. | REVISIONS | DATE: | BY: | FOR: |
|-----|-----------|-------|-----|------|
| | | | | |
| | | | | |
| | | | | |
| | | | | |

FIRM: McGhee Engineering
 DES BY: CWW CHK BY: MWW
 DWN BY: CWW APP BY:
 SCALE: AS SHOWN
 PROJECT DATE: 2018
 PRINTED:
 LENGTH OF BAR IS 1" ON ORIGINAL DRAWING

City of Guthrie, Kentucky
 NOVELIS SANITARY SEWER
 EXTENSION PROJECT
 Contract 1 - Sewer Line Extension
 Standard Gravity Sewer Details

MCGHEE
 ENGINEERING
 202 Ewing Street
 Guthrie, KY 42234
 (270) 483-9985

Guthrie
 WATER & SEWER
 P.O. Box 125
 Guthrie, KY 42234
 (270) 483-2511

DRAWING NO.
 SHEET D-1

