

Specifications & Contract Documents

prepared for



**THE
CITY
OF**

GUTHRIE

for the proposed

**CITY-WIDE METER
CHANGE OUT PROJECT**

prepared by

MCGHEE ENGINEERING, INC.
Guthrie, Kentucky

October 2022

Specifications and Contract Documents
City-Wide Meter Change Out Project

prepared for



**THE
CITY
OF**

GUTHRIE

Jimmy Covington
Mayor

City Council

Harry Green
Norma Williams
Katie Covington

Zollie Rose
Pam Turner
Doreen Lynch

Prepared by

MCGHEE ENGINEERING, INC.
202 Ewing Street, P. O. Box 267
Guthrie, Kentucky 42234
(270) 483-9985

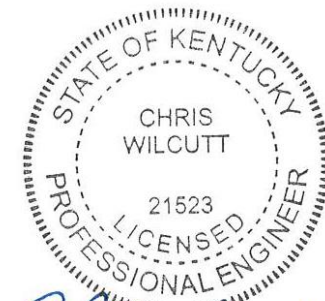

Chris Wilcutt

October 21, 2022

City of Guthrie Water & Sewer

CITY-WIDE METER CHANGE OUT PROJECT

CONTRACT DOCUMENTS

Table of Contents

<u>Bidding Documents</u>		<u>Pages</u>
Advertisement for Bids		1
Instructions to Bidders		12
Bid Bond (EJCDC C-430)		2
Bid Form (EJCDC C-410)		7
Statement of Experience		1
 <u>Agreement Section</u>		
Notice of Award		1
Agreement (EJCDC C-520)		6
Performance Bond (EJCDC C-610)		3
Payment Bond (EJCDC C-615)		3
Power of Attorney	(Provided by Contractor)	-
Notice to Proceed		1
Certificate of Insurance	(Provided by Contractor)	-
 <u>Conditions Section</u>		
General Conditions (EJCDC C-700)		66
Supplementary Conditions		25
Contract Change Order Form (RD 1924-7)		1
Project Special Conditions		3
 <u>Technical Specifications</u>		
01-100	Summary of Work	4
01-200	Submittals	1
02-100	Water Main General Requirements	5
02-200	Water Main Materials	8
02-201	Automated Water Meter Reading System	6
02-300	Water Main Construction	12
02-500	Water Main Measurement & Payment - Labor Bid Items & Supplemental Bid Items Only	3
 <u>Appendix</u>		
1	Guthrie Water System Map – <i>prepared by the Pennyrile Area Development District</i>	
2	Guthrie Water Account List with Meter Addresses - <u><i>provided to the Awarded Contractor</i></u>	
 <u>Contract Drawings</u>		
Contract Drawings consist of 1 sheets bound separately from this document		

ADVERTISEMENT FOR BIDS

City of Guthrie
P.O. Box 125 – 110 Kendall Street
Guthrie, KY 42234

RE: City-wide Meter Change Out Project

The **City of Guthrie** will receive separate, sealed Proposals for their **City-wide Meter Change Out Project** until **2:00 p.m. local time, Tuesday, December 20, 2022** at the Guthrie City Hall, 110 Kendall Street, P.O. Box 125, Guthrie, Kentucky, 42234, at which time they will be publicly opened and read aloud.

The contract involves the purchase and installation of all equipment, hardware & software for use in implementing an automated water meter reading system throughout the Guthrie water system (Todd County). Presently, there are approximately 795 total meters, of various sizes, to be changed out in the system.

The Issuing Office for the Bidding Documents is: McGhee Engineering, Inc., at P.O. Box 267, 202 South Ewing Street, Guthrie, Kentucky 42234 or by calling (270) 483-9985. Perspective Bidders may examine the Bidding Documents at the Issuing Office on Mondays through Fridays between the hours of 8:30-4:30 pm, and may obtain copies of the Bidding Documents from the Issuing Office as described below. Plans must be ordered by visiting www.mcgheeengineering.com and clicking "**Bid Opportunities**". Plans will be sold with an option of Digital only OR Printed Set w/ Digital copy. Bids will be accepted only from registered contractors holding approved bid forms provided by the Issuing Office. Plan holders may be viewed at www.mcgheeengineering.com.

This project is funded with City Reserve monies and possibly with Cleaner Water Program (CWP) grant funds administered through the Kentucky Infrastructure Authority (KIA). Applicable CWP requirements and provisions must be met by the Bidder and all subcontractors.

Small and Disadvantaged Business Enterprises are encouraged to participate in this project. The City of Guthrie is an Equal Opportunity Employer. **The City reserves the right to reject any or all Bids, to waive any technicality, and to accept any Bid which it deems advantageous. Also, the OWNER reserves the right to award only the equipment purchase portion of the work, at the stated unit prices, due to the possible limited funds available for the project. All Bids shall remain subject to acceptance for 90 days after the time set for receiving proposals.**

Published by the authority of the City of Guthrie
Jimmy Covington, Mayor

Dated: November 29, 2022

INSTRUCTIONS TO BIDDERS

A. These Instructions to Bidders establish requirements for Bidding and Award of Contract.

B. Table of Articles

Article 1 – Defined Terms

Article 2 – Copies of Bidding Documents

Article 3 – Qualifications of Bidders

Article 4 – Site and Other Areas; Existing Site Conditions; Examination of Site; Owner’s Safety Program;
Other Work at the Site

Article 5 – Bidder’s Representations

Article 6 – Pre-Bid Conference

Article 7 – Interpretations and Addenda

Article 8 – Bid Security

Article 9 – Contract Times

Article 10 – Liquidated Damages

Article 11 – Substitute and “Or-Equal” Items

Article 12 – Subcontractors, Suppliers, and Others

Article 13 – Preparation of Bid

Article 14 – Basis of Bid

Article 15 – Submittal of Bid

Article 16 – Modification and Withdrawal of Bid

Article 17 – Opening of Bids

Article 18 – Bids to Remain Subject to Acceptance

Article 19 – Evaluation of Bids and Award of Contract

Article 20 – Bonds and Insurance

Article 21 – Signing of Agreement

Article 22 – Retainage

Article 23 – Licenses, Fees & Taxes

Article 24 – Wage Rate Determination

Article 25 – Other Bid Requirements

Article 26 – Laws, Ordinances & Regulations

Article 27 – Insurance

Article 28 – Safety Standards & Accident Prevention

ARTICLE 1- DEFINED TERMS

Other terms used in the bidding documents and not defined elsewhere have the following meanings which are applicable to both the singular and plural thereof.

1.01 Terms used in these Instructions to Bidders will have the meanings indicated in the General Conditions and the Supplementary Conditions. Additional terms used in these Instructions to Bidders have the meanings indicated below which are applicable to both the singular and plural thereof.

- A. Bidder - The individual or entity who submits a Bid directly to OWNER.
- B. Issuing Office - The office from which the Bidding Documents are to be issued.
- C. Successful Bidder - The lowest responsible Bidder submitting a responsive Bid to whom OWNER (on the basis of OWNER's evaluation as hereinafter provided) makes an award.

ARTICLE 2 - COPIES OF BIDDING DOCUMENTS

2.01 Complete sets of the Bidding Documents may be obtained from the Issuing Office in the number and format stated in the advertisement or invitation to bid.

2.02 Complete sets of Bidding Documents must be used in preparing Bids; neither OWNER nor ENGINEER assume any responsibility for errors or misinterpretations resulting from the use of incomplete sets of Bidding Documents.

2.03 OWNER and ENGINEER in making copies of Bidding Documents available on the above terms do so only for the purpose of obtaining Bids for the Work and do not confer a license or grant for any other use.

ARTICLE 3 - QUALIFICATIONS OF BIDDERS

3.01 To demonstrate Bidder's qualifications to perform the Work, after submitting its Bid and within **10** days of Owner's request, Bidder shall submit (a) written evidence establishing its qualifications such as financial data, previous experience, and present commitments, and (b) the following additional information:

- A. Evidence of Bidder's authority to do business in the state where the Project is located.
- B. Bidder's state or other contractor license number, if applicable.
- C. Subcontractor and Supplier qualification information; coordinate with provisions of Article 12 of these Instructions, "Subcontractors, Suppliers, and Others."

3.02 A Bidder's failure to submit required qualification information within the times indicated may disqualify Bidder from receiving an award of the Contract.

3.03 No requirement in this Article 3 to submit information will prejudice the right of Owner to seek additional pertinent information regarding Bidder's qualifications.

3.04 Bidder is advised to carefully review those portions of the Bid Form requiring Bidder's representations and certifications.

ARTICLE 4 - SITE AND OTHER AREAS; EXISTING SITE CONDITIONS; EXAMINATION OF SITE; OWNER'S SAFETY PROGRAM; OTHER WORK AT THE SITE

4.01 *Site and Other Areas*

- A. The Site is identified in the Bidding Documents. By definition, the Site includes rights-of-way, easements, and other lands furnished by Owner for the use of the Contractor. Any additional lands required for temporary construction facilities, construction equipment, or storage of materials and equipment, and any access needed for such additional lands, are to be obtained and paid for by Contractor.

4.02 *Existing Site Conditions*

- A. Subsurface and Physical Conditions; Hazardous Environmental Conditions
 - 1. The Supplementary Conditions identify:
 - a. those reports known to Owner of explorations and tests of subsurface conditions at or adjacent to the Site.
 - b. those drawings known to Owner of physical conditions relating to existing surface or subsurface structures at the Site (except Underground Facilities).
 - c. reports and drawings known to Owner relating to Hazardous Environmental Conditions that have been identified at or adjacent to the Site.
 - d. Technical Data contained in such reports and drawings.
 - 2. Owner will make copies of reports and drawings referenced above available to any Bidder on request. These reports and drawings are not part of the Contract Documents, but the Technical Data contained therein upon whose accuracy Bidder is entitled to rely, as provided in the General Conditions, has been identified and established in the Supplementary Conditions. Bidder is responsible for any interpretation or conclusion Bidder draws from any Technical Data or any other data, interpretations, opinions, or information contained in such reports or shown or indicated in such drawings.
 - 3. If the Supplementary Conditions do not identify Technical Data, the default definition of Technical Data set forth in Article 1 of the General Conditions will apply.
- B. Underground Facilities: Information and data shown or indicated in the Bidding Documents with respect to existing Underground Facilities at or adjacent to the Site are set forth in the Contract Documents and are based upon information and data furnished to Owner and Engineer by owners of such Underground Facilities, including Owner, or others.
- C. Adequacy of Data: Provisions concerning responsibilities for the adequacy of data furnished to prospective Bidders with respect to subsurface conditions, other physical conditions, and Underground Facilities, and possible changes in the Bidding Documents due to differing or unanticipated subsurface or physical conditions appear in Paragraphs 5.03, 5.04, and 5.05 of the General Conditions. Provisions concerning responsibilities for the adequacy of data furnished to prospective Bidders with respect to a Hazardous Environmental Condition at the Site, if any, and possible changes in the Contract Documents due to any Hazardous Environmental Condition uncovered or revealed at the Site which was not shown or indicated in the Drawings or Specifications or identified in the Contract Documents to be within the scope of the Work, appear in Paragraph 5.06 of the General Conditions.

4.03 *Site Visit and Testing by Bidders*

- A. Bidder shall conduct the required Site visit during normal working hours, and shall not disturb any ongoing operations at the Site.

- B. Bidder is not required to conduct any subsurface testing, or exhaustive investigations of Site conditions.
- C. On request, and to the extent Owner has control over the Site, and schedule permitting, the Owner will provide Bidder access to the Site to conduct such additional examinations, investigations, explorations, tests, and studies as Bidder deems necessary for preparing and submitting a successful Bid. Owner will not have any obligation to grant such access if doing so is not practical because of existing operations, security or safety concerns, or restraints on Owner's authority regarding the Site.
- D. Bidder shall comply with all applicable Laws and Regulations regarding excavation and location of utilities, obtain all permits, and comply with all terms and conditions established by Owner or by property owners or other entities controlling the Site with respect to schedule, access, existing operations, security, liability insurance, and applicable safety programs.
- E. Bidder shall fill all holes and clean up and restore the Site to its former condition upon completion of such explorations, investigations, tests, and studies.

4.04 *Owner's Safety Program*

- A. Site visits and work at the Site may be governed by an Owner safety program. As the General Conditions indicate, if an Owner safety program exists, it will be noted in the Supplementary Conditions.

4.05 *Other Work at the Site*

- A. Reference is made to Article 8 of the Supplementary Conditions for the identification of the general nature of other work of which Owner is aware (if any) that is to be performed at the Site by Owner or others (such as utilities and other prime contractors) and relates to the Work contemplated by these Bidding Documents. If Owner is party to a written contract for such other work, then on request, Owner will provide to each Bidder access to examine such contracts (other than portions thereof related to price and other confidential matters), if any.

ARTICLE 5 – BIDDER'S REPRESENTATIONS

5.01 It is the responsibility of each Bidder before submitting a Bid to:

- A. examine and carefully study the Bidding Documents, and any data and reference items identified in the Bidding Documents;
- B. visit the Site, conduct a thorough, alert visual examination of the Site and adjacent areas, and become familiar with and satisfy itself as to the general, local, and Site conditions that may affect cost, progress, and performance of the Work;
- C. become familiar with and satisfy itself as to all Laws and Regulations that may affect cost, progress, and performance of the Work,
- D. carefully study all: (1) reports of explorations and tests of subsurface conditions at or adjacent to the Site and all drawings of physical conditions relating to existing surface or subsurface structures at the Site that have been identified in the Supplementary Conditions, especially with respect to Technical Data in such reports and drawings, and (2) reports and drawings relating to Hazardous Environmental Conditions, if any, at or adjacent to the Site that have been identified in the Supplementary Conditions, especially with respect to Technical Data in such reports and drawings;
- E. consider the information known to Bidder itself; information commonly known to contractors doing business in the locality of the Site; information and observations obtained from visits to the Site; the Bidding Documents; and the Site-related reports and drawings identified in the

Bidding Documents, with respect to the effect of such information, observations, and documents on (1) the cost, progress, and performance of the Work; (2) the means, methods, techniques, sequences, and procedures of construction to be employed by Bidder; and (3) Bidder's safety precautions and programs;

- F. agree, based on the information and observations referred to in the preceding paragraph, that at the time of submitting its Bid no further examinations, investigations, explorations, tests, studies, or data are necessary for the determination of its Bid for performance of the Work at the price bid and within the times required, and in accordance with the other terms and conditions of the Bidding Documents;
- G. become aware of the general nature of the work to be performed by Owner and others at the Site that relates to the Work as indicated in the Bidding Documents;
- H. promptly give Engineer written notice of all conflicts, errors, ambiguities, or discrepancies that Bidder discovers in the Bidding Documents and confirm that the written resolution thereof by Engineer is acceptable to Bidder;
- I. determine that the Bidding Documents are generally sufficient to indicate and convey understanding of all terms and conditions for the performance and furnishing of the Work; and
- J. agree that the submission of a Bid will constitute an incontrovertible representation by Bidder that Bidder has complied with every requirement of this Article, that without exception the Bid and all prices in the Bid are premised upon performing and furnishing the Work required by the Bidding Documents.

ARTICLE 6 – PRE-BID CONFERENCE

6.01 If warranted, a pre-Bid conference will be held at the time and location stated in the invitation or advertisement for bids. Representatives of Owner and Engineer will be present to discuss the Project. Bidders are encouraged to attend and participate in the conference. Engineer will transmit to all prospective Bidders of record such Addenda as Engineer considers necessary in response to questions arising at the conference. Oral statements may not be relied upon and will not be binding or legally effective.

ARTICLE 7 - INTERPRETATIONS AND ADDENDA

7.01 All questions about the meaning or intent of the Bidding Documents are to be submitted to Engineer in writing. Interpretations or clarifications considered necessary by Engineer in response to such questions will be issued by Addenda delivered to all parties recorded as having received the Bidding Documents. Questions received less than seven days prior to the date for opening of Bids may not be answered. Only questions answered by Addenda will be binding. Oral and other interpretations or clarifications will be without legal effect.

7.02 Addenda may be issued to clarify, correct, supplement, or change the Bidding Documents. Addenda will be mailed no later than **three days** prior to the day set for receiving Bids. Failure of any Bidder to receive any such Addendum or interpretation shall not relieve such Bidder from any obligations under the Bid as submitted. All Addenda so issued shall become part of the Contract Documents.

7.03 Addenda may also be issued to clarify, correct, or change the Bidding Documents as deemed advisable by OWNER or ENGINEER.

7.04 Receipt of all addenda must be acknowledged in space provided in the Bid.

ARTICLE 8 - BID SECURITY

8.01 A Bid must be accompanied by Bid security made payable to OWNER in an amount of **five percent (5%)** of the Bidder's maximum Bid price and in the form of a certified check or a Bid Bond (EJCDC No. C-430, 2013 Edition) issued by a surety meeting the requirements of paragraphs 6.01 and 6.02 of the General Conditions.

8.02 The Bid security of the apparent Successful Bidder will be retained until Owner awards the contract to such Bidder, and such Bidder has executed the Contract Documents, furnished the required contract security, and met the other conditions of the Notice of Award, whereupon the Bid security will be released. If the Successful Bidder fails to execute and deliver the Contract Documents and furnish the required contract security within 10 days after the Notice of Award, Owner may consider Bidder to be in default, annul the Notice of Award, and the Bid security of that Bidder will be forfeited. Such forfeiture shall be Owner's exclusive remedy if Bidder defaults.

8.03 The Bid security of other Bidders that Owner believes to have a reasonable chance of receiving the award may be retained by Owner until the earlier of seven days after the Effective Date of the Contract or 91 days after the Bid opening, whereupon Bid security furnished by such Bidders will be released.

8.04 Bid security of other Bidders that Owner believes do not have a reasonable chance of receiving the award will be released within seven days after the Bid opening.

ARTICLE 9 - CONTRACT TIMES

9.01 The number of days within which, or the dates by which the Work is to be substantially completed, and completed and ready for final payment, are set forth in the Agreement.

ARTICLE 10 - LIQUIDATED DAMAGES

10.01 Provisions for liquidated damages, if any, for failure to timely attain Substantial Completion or completion of the Work in readiness for final payment, are set forth in the Agreement.

ARTICLE 11 - SUBSTITUTE OR "OR-EQUAL" ITEMS

11.01 The Contract for the Work, if awarded, will be on the basis of materials and equipment specified or described in the Bidding Documents, and those "or-equal" or substitute or materials and equipment subsequently approved by Engineer prior to the submittal of Bids and identified by Addendum. No item of material or equipment will be considered by Engineer as an "or-equal" or substitute unless written request for approval has been submitted by Bidder and has been received by Engineer at least 15 days prior to the date for receipt of Bids in the case of a proposed substitute and 5 days prior in the case of a proposed "or equal". Each such request shall comply with the requirements of Paragraphs 7.04 and 7.05 of the General Conditions. Each such request shall include Manufacturer's Certification letter for compliance with AIS requirements and subsequent statutes mandating domestic preference, if applicable. Refer to Manufacturer's Certification Letter provided in these Contract Documents.

11.02 All prices that Bidder sets forth in its Bid shall be based on the presumption that the Contractor will furnish the materials and equipment specified or described in the Bidding Documents, as supplemented by Addenda. Any assumptions regarding the possibility of post-Bid approvals of "or-equal" or substitution requests are made at Bidder's sole risk.

11.03 If award is made, Contractor shall be allowed to submit proposed substitutes and "or equals" in accordance with the General Conditions.

ARTICLE 12 - SUBCONTRACTORS, SUPPLIERS, AND OTHERS

12.01 A list of subcontractors, suppliers, individuals, or entities shall be submitted along with the Bid at the Bid Opening to the OWNER. If requested by Owner, such list shall be accompanied by an experience statement with pertinent information regarding similar projects and other evidence of qualification for each such Subcontractor, Supplier, or other individual or entity. If Owner or Engineer, after due investigation, has reasonable objection to any proposed Subcontractor, Supplier, individual, or entity, Owner may, before the Notice of Award is given, request apparent Successful Bidder to submit an acceptable substitute, in which case apparent Successful Bidder shall submit a substitute, Bidder's Bid price will be increased (or decreased) by the difference in cost occasioned by such substitution, and Owner may consider such price adjustment in evaluating Bids and making the Contract award.

12.02 If apparent Successful Bidder declines to make any such substitution, Owner may award the Contract to the next lowest Bidder that proposes to use acceptable Subcontractors, Suppliers, or other individuals or entities. Declining to make requested substitutions will constitute grounds for forfeiture of the Bid security of any Bidder. Any Subcontractor, Supplier, individual, or entity so listed and against which Owner or Engineer makes no written objection prior to the giving of the Notice of Award will be deemed acceptable to Owner and Engineer subject to subsequent revocation of such acceptance as provided in Paragraph 7.06 of the General Conditions.

12.03 CONTRACTOR shall not be required to employ any subcontractor, supplier, individual, or entity against whom CONTRACTOR has reasonable objection.

12.04 The CONTRACTOR shall not award work to Subcontractor(s) in excess of the limits stated in SC 7.06.

ARTICLE 13 – PREPARATION OF BID

13.01 The Bid Form is included with the Bidding Documents.

- A. All blanks on the Bid form must be typed or completed in ink and the Bid Form signed in ink. Erasures or alterations shall be initialed in ink by the person signing the Bid Form. A Bid price shall be indicated for each section, Bid item, alternative, adjustment unit price item, and unit price item listed therein.
- B. If the Bid Form expressly indicates that submitting pricing on a specific alternate item is optional, and Bidder elects to not furnish pricing for such optional alternate item, then Bidder may enter the words "No Bid" or "Not Applicable."

13.02 A Bid by a corporation shall be executed in the corporate name by a corporate officer (whose title must appear under the signature), accompanied by evidence of authority to sign. The corporate address and state of incorporation shall be shown. The corporate seal shall be affixed and attested by the secretary or an assistant secretary.

13.03 A Bid by a partnership shall be executed in the partnership name and signed by a partner (whose title must appear under the signature), accompanied by evidence of authority to sign. The official address of the partnership shall be shown below the signature.

13.04 A Bid by a limited liability company shall be executed in the name of the firm by a member and accompanied by evidence of authority to sign. The state of formation of the firm and the official address of the firm shall be shown below the signature.

13.05 A Bid by an individual shall show the Bidder's name and address for receiving notices.

13.06 A Bid by a joint venture shall be executed by each joint venturer in the manner indicated on the Bid form. The joint venture's address for receiving notices shall be shown.

13.07 All names shall be typed or printed in ink below the signatures.

13.08 The Bid shall contain an acknowledgment of receipt of all Addenda, the number and dates of which must be filled in on the Bid form.

13.09 Postal and e-mail addresses and telephone number for communications regarding the Bid shall be shown.

13.10 The Bid shall contain evidence of Bidder's authority and qualification to do business in the state where the Project is located, or Bidder shall covenant in writing to obtain such authority and qualification prior to award of the Contract and attach such covenant to the Bid. Bidder's state contractor license number, if any, shall also be shown on the Bid Form.

ARTICLE 14 - BASIS OF BID; COMPARISON OF BIDS

14.01 Bidders shall submit a Bid on a unit price basis for each item of Work listed in the unit price section of the Bid Form.

14.02 The "Bid Price" (sometimes referred to as the extended price) for each unit price Bid item will be the product of the "Estimated Quantity" (which Owner or its representative has set forth in the Bid Form) for the item and the corresponding "Bid Unit Price" offered by the Bidder. The total of all unit price Bid items will be the sum of these "Bid Prices"; such total will be used by Owner for Bid comparison purposes. The final quantities and Contract Price will be determined in accordance with Paragraph 13.03 of the General Conditions.

14.03 Discrepancies between the multiplication of units of Work and unit prices will be resolved in favor of the unit prices. Discrepancies between the indicated sum of any column of figures and the correct sum thereof will be resolved in favor of the correct sum.

ARTICLE 15 - SUBMITTAL OF BID

15.01 Bid Form is to be completed and submitted with all the attachments as required. Bidder shall furnish at least one separate, unbound copy of the Bid Form, along with the Bidder's Qualifications Statement in a sealed envelope. **If Bidder offers other products that also meets the project's needs and specifications, the Bidder may elect to turn in an additional bid for consideration, which includes a separate, unbound copy of the Bid Form along with the Bidder's Qualifications Statement, all in a separate sealed envelope.** All envelopes prepared as outlined in Paragraph 15.02.

15.02 A Bid shall be received no later than the date and time prescribed and at the place indicated in the advertisement or invitation to bid and shall be enclosed in a plainly marked package with the Project title (and, if applicable, the designated portion of the Project for which the Bid is submitted), the name and address of Bidder, and shall be accompanied by the Bid security and other required documents. If a Bid is sent by mail or other delivery system, the sealed envelope containing the Bid shall be enclosed in a separate package plainly marked on the outside with the notation "BID ENCLOSED." A mailed Bid shall be addressed to the location of the bid opening, as listed in the Advertisement.

15.03 Bids received after the date and time prescribed for the opening of bids, or not submitted at the correct location or in the designated manner, will not be accepted and will be returned to the Bidder unopened.

ARTICLE 16 - MODIFICATION AND WITHDRAWAL OF BIDS

16.01 A Bid may be modified or withdrawn by an appropriate document duly executed in the manner that a Bid must be executed and delivered to the place where Bids are to be submitted prior to the date and time for the opening of Bids. Upon receipt of such notice, the unopened Bid will be returned to the Bidder.

16.02 If a Bidder wishes to modify its Bid prior to Bid opening, Bidder must withdraw its initial Bid in the manner specified in Paragraph 16.01 and submit a new Bid prior to the date and time for the opening of Bids.

16.03 If within 24 hours after Bids are opened any Bidder files a duly signed written notice with Owner and promptly thereafter demonstrates to the reasonable satisfaction of Owner that there was a material and substantial mistake in the preparation of its Bid, that Bidder may withdraw its Bid, and the Bid security will be returned. Thereafter, if the Work is rebid, that Bidder will be disqualified from further bidding on the Work.

ARTICLE 17 - OPENING OF BIDS

17.01 Bids will be opened at the time and place indicated in the advertisement or invitation to bid and, unless obviously non-responsive, read aloud publicly. An abstract of the amounts of the base Bids and major alternates, if any, will be made available to Bidders after the opening of Bids.

ARTICLE 18 - BIDS TO REMAIN SUBJECT TO ACCEPTANCE

18.01 All Bids will remain subject to acceptance for a period of **90 days**, but OWNER may, in its sole discretion, release any Bid and return the Bid security prior to the end of this period.

ARTICLE 19 – EVALUATION OF BIDS & AWARD OF CONTRACT

19.01 Owner reserves the right to reject any or all Bids, including without limitation, nonconforming, nonresponsive, unbalanced, or conditional Bids. Owner will reject the Bid of any Bidder that Owner finds, after reasonable inquiry and evaluation, to not be responsible. If Bidder purports to add terms or conditions to its Bid, takes exception to any provision of the Bidding Documents, or attempts to alter the contents of the Contract Documents for purposes of the Bid, then the Owner will reject the Bid as nonresponsive; provided that Owner also reserves the right to waive all minor informalities not involving price, time, or changes in the Work.

19.02 If Owner awards the contract for the Work, such award shall be to the responsible Bidder submitting the responsive Bid perceived by the Owner as offering the greatest advantage to the Owner.

19.03 Evaluation of Bids

- A. In evaluating Bids, OWNER will consider whether or not the Bids comply with the prescribed requirements, and such alternatives, unit prices, and other data as may be requested in the Bid form or prior to the Notice of Award.
- B. For the determination of the apparent low Bidder(s) when unit price bids are submitted, Bids will be compared on the basis of the total of the products of the estimated quantity of each item and unit price Bid for that item, together with any lump sum items.

19.04 In evaluating whether a Bidder is responsible, Owner will consider the qualifications of the Bidder and may consider the qualifications and experience of Subcontractors and Suppliers proposed for those

portions of the Work for which the identity of Subcontractors and Suppliers must be submitted as provided in the Bidding Documents.

19.05 Owner may conduct such investigations as Owner deems necessary to establish the responsibility, qualifications, and financial ability of Bidders and any proposed Subcontractors or Suppliers.

19.06 The Bid is subject to Kentucky Revised Statutes Section 45A.490 through 45A.494, which in general provides that a "resident bidder" of Kentucky is to be given a bidding preference over a "nonresident bidder" who is registered in a state that gives preference to its in-state resident bidders over a Kentucky resident bidder. The bidding preference is to be the same as that stipulated of the state of the "nonresident bidder." If the state of "nonresident bidder" provides no specific preference, then "resident" and "nonresident bidders" are to be treated the same when evaluating Bids.

19.07 If a Contract is to be awarded, OWNER will give the successful Bidder a Notice of Award within 90 days after the time set for opening Bids. **Note that the OWNER reserves the right to award only the equipment purchase portion of the work, at the stated unit prices, due to the possible limited funds available for the project.**

ARTICLE 20 - BONDS AND INSURANCE

20.01 Article 6 of the General Conditions, as may be modified by the Supplementary Conditions, sets forth OWNER's requirements as to performance and payment bonds and insurances. When the Successful Bidder delivers the executed Agreement to OWNER, it must be accompanied by the required performance and payment bonds and insurances.

20.02 All bonds required by the project shall be payable to the OWNER in an amount of one hundred percent of the Contractor's maximum Base Bid price.

ARTICLE 21 - SIGNING OF AGREEMENT

21.01 When the OWNER gives a Notice of Award to the Successful Bidder, it will be accompanied by a list of items and information required of the Successful Bidder for evaluation by the OWNER and funding agency, if applicable. Within **10** days thereafter, the successful Bidder shall deliver the full number of original copies of the items listed and the Notice must be acknowledged by the Successful Bidder within **10** days thereafter. After receipt of an acknowledged Notice of Award, a pre-construction meeting will be scheduled at which time the OWNER and Successful Bidder will execute the required number of Agreements and Notice to Proceed. After certification by the Local Counsel and any other required parties, the OWNER shall deliver one fully signed counterpart to the Successful Bidder along with a complete set of Drawings with appropriate identification. OWNER will furnish the Contractor up to three (3) sets of conforming Contract Documents, Technical Specifications and Plans free of charge. Additional sets may be obtained from the Engineer at commercial reproduction rates. The successful bidder shall commence work within ten (10) calendar days after receipt of written notice to proceed and shall progress therewith so that the work shall be completed in accordance with the terms of the Contract Documents within the time allowed after the date of the commencement of contract time.

21.02 This Contract is expected to be funded with City Reserves and possibly in part with funds provided by the Cleaner Water Program (CWP) grant funds as administered by the Kentucky Infrastructure Authority (KIA). CWP requirements and provisions must be met by the Bidder and all subcontractors.

21.03 Concurrence by KIA in the award of the Contract may be required before the Contract is effective.

ARTICLE 22 - RETAINAGE

22.01 Prior to Substantial Completion, OWNER will retain an amount equal to 5% of each progress payment application. Amounts previously retained shall not be paid to the CONTRACTOR until substantial completion of the Work. In no event shall the total Retainage be more than 5% of the value of the work satisfactorily completed.

22.02 Retainage shall be applicable to the Total Value of Work and Stored Materials less the Value of In-place OWNER Purchased Materials.

ARTICLE 23 – LICENSES, FEES, AND TAXES

23.01 The Bid shall include all taxes in effect at the time the Bid is submitted, unless specifically exempted in the Bidding Documents. No change will be allowed for taxes from which OWNER is exempt. Bidders who are uncertain as to what items are subject to tax, or who require further explanation or clarification, are requested to contact the State of Kentucky Revenue Cabinet.

23.02 Successful Bidder must comply with any City ordinances relating to Occupational License Fees, Business Licenses, payroll, and net profits taxes and any other ordinances which may apply to the project. Refer to the Supplementary Conditions SC-6.10 for additional information.

23.03 Successful Bidder must provide proof of having all such licenses or fees at or before the signing of the Contract.

ARTICLE 24 - WAGE RATE DETERMINATION

24.01 If the contract price is in excess of \$100,000, provisions of the Contract Work Hours and Safety Standards Act at 29 CFR 5.5(b) apply.

24.02 Pursuant to 2017 Kentucky House Bill 3, State prevailing wages do not apply to this Contract.

24.03 Federal Davis Bacon wage rates do not apply to this Contract.

ARTICLE 25 – OTHER BID REQUIREMENTS

25.01 Bidder shall complete the following documents attached to the Bid:

Statement of Experience

ARTICLE 26 – LAWS, ORDINANCES, AND REGULATIONS

26.01 Bidder must familiarize itself with all laws, ordinances, and regulations by federal, state, city, or other governmental agency, which by reason of being neglected or violated may affect the Work contemplated and must secure and pay the fee required for any permits which may be necessary unless such fees are otherwise indicated to be paid in the Bidding Documents.

26.02 Bidders must comply with Title VI of the Civil Rights Act of 1964, the Anti-Kickback Act, and the Contract Work Hours Standard Act.

26.03 Bidders must comply with the President's Executive Order No. 11246 as amended, which prohibits discrimination in employment regarding race, creed, color, sex or national origin.

26.04 This project will be in compliance with Executive Order 11246 (Equal Employment Opportunity) as amended.

26.05 The Contractor/Subcontractor will comply with 41CFR 60-4, in regard to affirmative action, to insure equal opportunity to females and minorities and will apply the time tables and goals set forth in 41 CFR 60-4.

26.06 Bidder will make positive efforts to use small, minority, women owned and disadvantaged businesses.

26.07 Bidder/Owner will comply to provisions for timely periodic payments and for limiting retainage (40 CFR 31.36).

ARTICLE 27 – INSURANCE

27.01 Before execution of Contract by OWNER, the successful Bidder shall furnish OWNER a certificate or certificates issued by or on behalf of insurers or a self-insurance program or group self insurance program, qualified to do business in the Commonwealth of Kentucky under KRS Chapter 304 or KRS Chapter 342, certifying that the successful Bidder complies with the Worker's Compensation laws of Kentucky and is insured or indemnified against public liability claims which may arise out of the performance of the Work under the proposed Contract.

ARTICLE 28 – SAFETY STANDARDS AND ACCIDENT PREVENTION:

28.01 With respect to all work performed under this contract, the contractor shall:

Comply with the safety standards provision of applicable laws, building and construction codes and the "Manual of Accident Prevention in Construction" published by the Associated General Contractors of America, the requirements of the Occupational Safety and Health Act of 1970 (Public Law 91-596), and the requirements of Title 29 of the Code of Federal Regulations, Section 1518 as published in the "federal Register", Volume 36, No. 75, Saturday, April 17, 1971. Exercise every precaution at all times for the prevention of accidents and the protection of persons (including employees) and property. Maintain at his/her office or other well know place at the job site, all articles necessary for giving first aid to the injured, and shall make standing arrangements for the immediate removal to a hospital or a doctor's care of persons (including employees), who may be injured on the job site before the employer has made a standing arrangement for removal of injured persons to a hospital or a doctor's care.

BID BOND

Any singular reference to Bidder, Surety, Owner or other party shall be considered plural where applicable.

BIDDER *(Name and Address):*

SURETY *(Name and Address of Principal Place of Business):*

OWNER *(Name and Address):*

**City of Guthrie
PO Box 125
Guthrie, Kentucky 42234**

BID

Bid Due Date:
Description *(Project Name and Include Location):*

BOND

Bond Number:
Date *(Not earlier than Bid due date):*
Penal sum _____ \$ _____
(Words) (Figures)

Surety and Bidder, intending to be legally bound hereby, subject to the terms set forth below, do each cause this Bid Bond to be duly executed by an authorized officer, agent, or representative.

BIDDER

SURETY

Bidder's Name and Corporate Seal (Seal) _____
Surety's Name and Corporate Seal (Seal)

By: _____
Signature

By: _____
Signature (Attach Power of Attorney)

Print Name

Print Name

Title

Title

Attest: _____
Signature

Attest: _____
Signature

Title

Title

Note: Above addresses are to be used for giving any required notice. Provide execution by any additional parties, such as joint ventures, if necessary.

PENAL SUM FORM

1. Bidder and Surety, jointly and severally, bind themselves, their heirs, executors, administrators, successors, and assigns to pay to Owner upon default of Bidder the penal sum set forth on the face of this Bond. Payment of the penal sum is the extent of Bidder's and Surety's liability. Recovery of such penal sum under the terms of this Bond shall be Owner's sole and exclusive remedy upon default of Bidder.
2. Default of Bidder shall occur upon the failure of Bidder to deliver within the time required by the Bidding Documents (or any extension thereof agreed to in writing by Owner) the executed Agreement required by the Bidding Documents and any performance and payment bonds required by the Bidding Documents.
3. This obligation shall be null and void if:
 - 3.1 Owner accepts Bidder's Bid and Bidder delivers within the time required by the Bidding Documents (or any extension thereof agreed to in writing by Owner) the executed Agreement required by the Bidding Documents and any performance and payment bonds required by the Bidding Documents, or
 - 3.2 All Bids are rejected by Owner, or
 - 3.3 Owner fails to issue a Notice of Award to Bidder within the time specified in the Bidding Documents (or any extension thereof agreed to in writing by Bidder and, if applicable, consented to by Surety when required by Paragraph 5 hereof).
4. Payment under this Bond will be due and payable upon default of Bidder and within 30 calendar days after receipt by Bidder and Surety of written notice of default from Owner, which notice will be given with reasonable promptness, identifying this Bond and the Project and including a statement of the amount due.
5. Surety waives notice of any and all defenses based on or arising out of any time extension to issue Notice of Award agreed to in writing by Owner and Bidder, provided that the total time for issuing Notice of Award including extensions shall not in the aggregate exceed 120 days from Bid due date without Surety's written consent.
6. No suit or action shall be commenced under this Bond prior to 30 calendar days after the notice of default required in Paragraph 4 above is received by Bidder and Surety and in no case later than one year after Bid due date.
7. Any suit or action under this Bond shall be commenced only in a court of competent jurisdiction located in the state in which the Project is located.
8. Notices required hereunder shall be in writing and sent to Bidder and Surety at their respective addresses shown on the face of this Bond. Such notices may be sent by personal delivery, commercial courier, or by United States Registered or Certified Mail, return receipt requested, postage pre-paid, and shall be deemed to be effective upon receipt by the party concerned.
9. Surety shall cause to be attached to this Bond a current and effective Power of Attorney evidencing the authority of the officer, agent, or representative who executed this Bond on behalf of Surety to execute, seal, and deliver such Bond and bind the Surety thereby.
10. This Bond is intended to conform to all applicable statutory requirements. Any applicable requirement of any applicable statute that has been omitted from this Bond shall be deemed to be included herein as if set forth at length. If any provision of this Bond conflicts with any applicable statute, then the provision of said statute shall govern and the remainder of this Bond that is not in conflict therewith shall continue in full force and effect.
11. The term "Bid" as used herein includes a Bid, offer, or proposal as applicable.

BID FORM

Project Identification: City of Guthrie Water & Sewer
City-wide Water Meter Change Out Project

Contract Identification: City-wide Water Meter Change Out Project

ARTICLE 1 – BID RECIPIENT

1.01 This Bid is Submitted to: City of Guthrie Water & Sewer
PO Box 125
Guthrie, Kentucky 42234

1.02 The undersigned Bidder proposes and agrees, if this Bid is accepted, to enter into an Agreement with Owner in the form included in the Bidding Documents to perform all Work as specified or indicated in the Bidding Documents for the prices and within the times indicated in the Bid and in accordance with the other terms and conditions of the Bidding Documents.

ARTICLE 2 – BIDDER’S ACKNOWLEDGMENTS

2.01 Bidder accepts all of the terms and conditions of the Instructions to Bidders, including without limitation those dealing with the disposition of Bid security. This Bid will remain subject to acceptance for **90 days** after the Bid opening, or for such longer period of time that Bidder may agree to in writing upon request of Owner.

ARTICLE 3 – BIDDER’S REPRESENTATIONS

3.01 In submitting this Bid, Bidder represents that:

A. Bidder has examined and carefully studied the Bidding Documents, and any data and reference items identified in the Bidding Documents, and hereby acknowledges receipt of the following Addenda:

Addendum No. _____ Dated _____
Addendum No. _____ Dated _____
Addendum No. _____ Dated _____

B. Bidder has visited the Point of Destination and site where the Goods or Special Services will be provided and become familiar with and is satisfied as to the observable local conditions that may affect cost, progress, or the furnishing of Goods and Special Services, if required to do so by the Bidding Documents, or if, in Bidder’s judgment, any local condition may affect cost, progress, or the furnishing of Goods and Special Services

C. Bidder is familiar with and has satisfied itself as to all Laws and Regulations that may affect cost, progress, performance of the Work.

D. Bidder has carefully studied all: (1) reports of explorations and tests of subsurface conditions at or adjacent to the Site and all drawings of physical conditions relating to existing surface or subsurface structures at the Site that have been identified in the Supplementary Conditions, especially with respect to Technical Data in such reports and drawings, and (2) reports and drawings relating to Hazardous Environmental Conditions, if any, at or adjacent to the Site that have been identified in the Supplementary Conditions, especially with respect to Technical Data in such reports and drawings.

E. Bidder has considered the information known to Bidder itself; information commonly known to contractors doing business in the locality of the Site; information and observations obtained from visits to the Site; the Bidding Documents; and any Site-related reports and drawings identified in the Bidding Documents, with respect to the effect of such information, observations, and documents on (1) the cost,

progress, and performance of the Work; (2) the means, methods, techniques, sequences, and procedures of construction to be employed by Bidder; and (3) Bidder's safety precautions and programs.

- F. Bidder agrees, based on the information and observations referred to in the preceding paragraph, that no further examinations, investigations, explorations, tests, studies, or data are necessary for the determination of this Bid for performance of the Work at the price bid and within the times required, and in accordance with the other terms and conditions of the Bidding Documents.
- G. Bidder is aware of the general nature of work to be performed by Owner and others at the Site that relates to the Work as indicated in the Bidding Documents.
- H. Bidder has given Engineer written notice of all conflicts, errors, ambiguities, or discrepancies that Bidder has discovered in the Bidding Documents, and confirms that the written resolution thereof by Engineer is acceptable to Bidder.
- I. The Bidding Documents are generally sufficient to indicate and convey understanding of all terms and conditions for the performance and furnishing of the Work.
- J. The submission of this Bid constitutes an incontrovertible representation by Bidder that Bidder has complied with every requirement of this Article, and that without exception the Bid and all prices in the Bid are premised upon performing and furnishing the Work required by the Bidding Documents.
- K. **The Bidder is aware that any salvageable brass components (i.e. setters, meters, etc) replaced by the project shall be delivered to the Owner. Coordination with the Owner for delivery of said components is the responsibility of the awarded bidder.**
- L. **The Bidder is aware that the OWNER reserves the right to award only the equipment purchase portion of the work (Part B), at the stated unit prices, due to the possible limited funds available for the project. Also, the Bidder understands final quantities of equipment and/or installations may differ at the time of the Notice to Proceed.**

ARTICLE 4 – BIDDER'S CERTIFICATION

4.01 Bidder certifies that:

- A. This Bid is genuine and not made in the interest of or on behalf of any undisclosed individual or entity and is not submitted in conformity with any collusive agreement or rules of any group, association, organization, or corporation;
- B. Bidder has not directly or indirectly induced or solicited any other Bidder to submit a false or sham Bid;
- C. Bidder has not solicited or induced any individual or entity to refrain from bidding; and
- D. Bidder has not engaged in corrupt, fraudulent, collusive, or coercive practices in competing for the Contract. For the purposes of this Paragraph 4.01.D:
 - 1. "corrupt practice" means the offering, giving, receiving, or soliciting of anything of value likely to influence the action of a public official in the bidding process;
 - 2. "fraudulent practice" means an intentional misrepresentation of facts made (a) to influence the bidding process to the detriment of Owner, (b) to establish bid prices at artificial non-competitive levels, or (c) to deprive Owner of the benefits of free and open competition;

3. "collusive practice" means a scheme or arrangement between two or more Bidders, with or without the knowledge of Owner, a purpose of which is to establish bid prices at artificial, non-competitive levels; and
4. "coercive practice" means harming or threatening to harm, directly or indirectly, persons or their property to influence their participation in the bidding process or affect the execution of the Contract.

ARTICLE 5 – BASIS OF BID

5.01 Bidder will furnish the Goods and Special Services in accordance with the Contract Documents for the following price(s):

BASE BID – AUTOMATED DRIVE-BY SYSTEM:

BASE BID – ‘PART A’ – Meter Installations & Modification (LABOR)				
ITEM	QUANTITY	UNITS	UNIT PRICE	TOTAL
5/8"x3/4" residential type water meter – change out old meter with new meter & communication transceiver unit	765	EA	\$	\$
1" water meter - change out old meter with new meter & communication transceiver unit	20	EA	\$	\$
2" water meter - change out old meter with new meter & communication transceiver unit	8	EA	\$	\$
4" water meter - change out old meter with new meter & communication transceiver unit	1	EA	\$	\$
6" water meter - change out old meter with new meter & communication transceiver unit	1	EA	\$	\$
Modification of Existing Meter Lid to equip with individual transceiver unit (as applicable to respective meter read system)	795	EA	\$	\$
SUB-TOTAL BASE BID – ‘PART A’ AMOUNT				\$ _____
BASE BID – ‘PART B’ – Automated Drive-By System (EQUIPMENT)				
ITEM	QUANTITY	UNITS	UNIT PRICE	TOTAL
5/8"x3/4" residential type water meter with drive-by read capability	765	EA	\$	\$
1" residential type water meter with drive-by read capability	20	EA	\$	\$
2" (ultrasonic or electromagnetic) water meter with drive-by read capability	8	EA	\$	\$
4" (ultrasonic or electromagnetic) water meter with drive-by read capability	1	EA	\$	\$
6" (ultrasonic or electromagnetic) water meter with drive-by read capability	1	EA	\$	\$
Individual Transceiver Unit for 5/8"x3/4" residential type water meter to provide communication with drive-by read system	765	EA	\$	\$
Individual Transceiver Unit for 1" residential type water meter to provide communication with drive-by read system	20	EA	\$	\$
Individual Transceiver Unit for 2" water meter to provide communication with drive-by read system	8	EA	\$	\$
Individual Transceiver Unit for 4" water meter to provide communication with drive-by read system	1	EA	\$	\$
Individual Transceiver Unit for 6" water meter to provide communication with drive-by read system	1	EA	\$	\$

Remote reading system including notebook computer, handheld units, radio receiver, all software, supplies and services, set-up and training.	1	LS	\$	\$
SUB-TOTAL BASE BID – ‘PART B’ AMOUNT				\$ _____
TOTAL BASE BID AMOUNT				\$ _____
For the smaller meter sizes (1" or smaller), the Bidder's AMR system utilizes (check one): <input type="checkbox"/> Electromagnetic Type <input type="checkbox"/> Ultrasonic Type (solid state)				

SUPPLEMENTAL EQUIPMENT BASE BID ITEMS:

ITEM	QUANTITY	UNITS	UNIT PRICE
1-1/2" residential type water meter with drive-by read capability	0-5	EA	\$

This Base Bid offer is made with (check all that apply):

- Meter Manufacturer Brand (Specify) _____
- Estimated annual costs (i.e. subscriptions, fees), if applicable: \$ _____ /year
- No exceptions to the specifications and instructions to bidders.
- Exceptions as described in a _____ page attachment to this bid.

ALTERNATE BID – AUTOMATED FIXED BASED SYSTEM (Radio or Cellular):

ALTERNATE BID – ‘PART A’ – Meter Installations & Modification (LABOR)				
ITEM	QUANTITY	UNITS	UNIT PRICE	TOTAL
5/8"x3/4" residential type water meter – change out old meter with new meter & communication transceiver unit	765	EA	\$	\$
1" water meter - change out old meter with new meter & communication transceiver unit	20	EA	\$	\$
2" water meter - change out old meter with new meter & communication transceiver unit	8	EA	\$	\$
4" water meter - change out old meter with new meter & communication transceiver unit	1	EA	\$	\$
6" water meter - change out old meter with new meter & communication transceiver unit	1	EA	\$	\$
Modification of Existing Meter Lid to equip with individual transceiver unit (as applicable to respective meter read system)	795	EA	\$	\$
SUB-TOTAL BASE BID – ‘PART A’ AMOUNT				\$ _____
ALTERNATE BID – ‘PART B’ – Automated Fixed Based Read System (EQUIPMENT)				
ITEM	QUANTITY	UNITS	UNIT PRICE	TOTAL
5/8"x3/4" residential type water meter with fixed based read capability	765	EA	\$	\$

1" residential type water meter with fixed based read capability	20	EA	\$	\$
2" (ultrasonic or electromagnetic) water meter with fixed based read capability	8	EA	\$	\$
4" (ultrasonic or electromagnetic) water meter with fixed based read capability	1	EA	\$	\$
6" (ultrasonic or electromagnetic) water with fixed based read capability	1	EA	\$	\$
Individual Transceiver Unit for 5/8"x3/4" residential type water meter to provide communication with fixed based read system	765	EA	\$	\$
Individual Transceiver Unit for 1" residential type water meter to provide communication with fixed based read system	20	EA	\$	\$
Individual Transceiver Unit for 2" water meter to provide communication with fixed based read system	8	EA	\$	\$
Individual Transceiver Unit for 4" water meter to provide communication with fixed based read system	1	EA	\$	\$
Individual Transceiver Unit for 6" water meter to provide communication with fixed based read system	1	EA	\$	\$
Remote reading system including notebook computer, handheld units, <u>at least one</u> fixed base radio receiver & mounting, all software, supplies and services, set-up and training.	1	LS	\$	\$
SUB-TOTAL BASE BID – ‘PART B’ AMOUNT				\$ _____
TOTAL ALTERNATIVE BID AMOUNT For the smaller meter sizes (1" or smaller), the Bidder's AMI system utilizes (check one) : <input type="checkbox"/> Electromagnetic Type <input type="checkbox"/> Ultrasonic Type (solid state) Bidder's alternate system utilizes (check one) : <input type="checkbox"/> Cellular Communication <input type="checkbox"/> Radio Communication				\$ _____

SUPPLEMENTAL EQUIPMENT ALTERNATE BID ITEMS:

ITEM	QUANTITY	UNITS	UNIT PRICE
1-1/2" water meter with fixed based read capability	0-5	EA	\$

This Alternate Bid offer is made with (check all that apply):

- Meter Manufacturer Brand (Specify) _____
- Estimated annual costs (i.e. subscriptions, fees), if applicable: \$ _____ /year
- No exceptions to the specifications and instructions to bidders.
- Exceptions as described in a _____ page attachment to this bid.:

5.02 Unit prices have been computed in accordance with paragraph 11.03A of the General Conditions.

5.03 Bidder acknowledges that estimated quantities are not guaranteed, and are solely for the purpose of comparison of Bids, and final payment for all Unit Price Bid items will be based on actual quantities, determined as provided in the Contract Documents.

5.04 **SUPPLEMENTAL UNIT PRICES:** The following Supplemental Unit Prices will apply in the event that additions to or deductions from the work required in the Bid are ordered. A single price shall be bid for each

item. OWNER reserves the right to accept or reject these prices by inclusion in or omission from the Contract Documents to be executed after the award of the Contract.

Item	Type of Work	Unit	Supplemental Unit Price		
			(Words)		(Numbers)
1.	Replacement & Reconnection of Near Side, 5/8"x3/4" AMR Water Meter to existing water main & customer-side service line with ALL new tubing (up to 10 LF), new box, new setter, tracer wire & applicable fittings; in place & ready for use.	EA	_____.	Dollars	\$_____.
2.	Replacement & Reconnection of Far Side, 5/8"x3/4" AMR Water Meter to existing water main & customer-side service line w/ All new tubing (up to 50 LF) <u>encased under roadway</u> , new box, new setter, tracer wire & applicable fittings; in place & ready for use.	EA	_____.	Dollars	\$_____.
3.	Concrete Pavement Replacement & Backfill of affected service line trench and/or meter area; in place, complete & ready for use.	SF	_____.	Dollars	\$_____.
4.	Asphalt Pavement Replacement & Backfill of affected service line trench and/or meter area; in place, complete & ready for use.	SF	_____.	Dollars	\$_____.
5.	Completely New service tap with 3/4" brass saddle on existing 3" water main + removal & repair of old saddle and tap. Complete.	EA	_____.	Dollars	\$_____.
6.	Completely New service tap with 3/4" brass saddle on existing 4" water main + removal & repair of old saddle and tap. Complete.	EA	_____.	Dollars	\$_____.
7.	Completely New service tap with 3/4" brass saddle on existing 6" water main + removal & repair of old saddle and tap. Complete.	EA	_____.	Dollars	\$_____.
8.	Completely New service tap with 3/4" brass saddle on existing 8" water main + removal & repair of old saddle and tap. Complete.	EA	_____.	Dollars	\$_____.
9.	3/4" HDPE Water Service Tubing (<u>Additional Tubing Footage > than lengths listed in Supplemental Bid Item 01 or 02; as approved by Owner.</u>)	LF	_____.	Dollars	\$_____.
10.	Replacement of Existing Meter Box & Lid (box & lid only) which is compatible with radio read system	EA	_____.	Dollars	\$_____.
11.	Replacement of Existing 5/8"x3/4" Meter Setter (Setter Only) which is compatible with New Water Meter	EA	_____.	Dollars	\$_____.

ARTICLE 6 – TIME OF COMPLETION

6.01 Bidder agrees that the Work will be substantially complete and will be completed and ready for final payment in accordance with Paragraph 15.06 of the General Conditions on or before the dates or within the number of calendar days indicated in the Agreement.

6.02 Bidder accepts the provisions of the Agreement as to liquidated damages.

ARTICLE 7 – ATTACHMENTS TO THIS BID

7.01 The following documents are attached to and made a condition of the Bid:

- A. Required Bid security in the form of a Bid Bond (EJCDC No. C-430) or Certified Check (circle type of security provided);
- B. Statement of Experience

ARTICLE 8 – DEFINED TERMS

8.01 The terms used in this Bid with the initial capital letters have the meanings indicated in the Instructions to Bidders, the General Conditions, and the Supplementary Conditions.

ARTICLE 9 – BID SUBMITTAL

9.01 This Bid submitted by:

Submitted by:

Signature	Business
Printed or Typed Name	Bidder's Business Address
Title	City, State, Zip Code
Employer's Tax ID No.	Business Phone No. Business Fax No.
Business Email Address	Cell Phone No. Other Contact No.

9.02 Bid submitted on _____, 2022.

Seal (if required)

STATEMENT OF EXPERIENCE

The following list represents the most recent clients for whom similar work was performed by the BIDDER. The persons listed may be contacted as references. Provide at least four unique and non-Owner related project references.

No.	Contact Person, Company & Phone No.	Project Description, Date & Approximate Value of Work
1.	_____ _____ _____	_____ _____ _____
2.	_____ _____ _____	_____ _____ _____
3.	_____ _____ _____	_____ _____ _____
4.	_____ _____ _____	_____ _____ _____
5.	_____ _____ _____	_____ _____ _____
6.	_____ _____ _____	_____ _____ _____

Bidder

NOTICE OF AWARD

TO: _____

PROJECT Description: **City of Guthrie Water & Sewer
City-wide Meter Change Out Project**

The OWNER has considered the BID submitted by you for the above-described WORK in response to its Advertisement for Bids dated **November 16, 2022** and Instructions to Bidders.

You are hereby notified that your BASE BID (Specify) has been accepted for items in the amount of \$ _____

You are required by the Instructions to Bidders to execute the Agreement and furnish the required CONTRACTOR'S Performance BOND, Payment BOND and certificates of insurance within ten (10) calendar days from the date of this Notice to you.

If you fail to execute said Agreement and to furnish said BONDS within ten (10) days from the date of this Notice, said OWNER will be entitled to consider all your rights arising out of the OWNER's acceptance of your BID as abandoned and as a forfeiture of your BID BOND. The OWNER will be entitled to such other rights as may be granted by law.

Within ten (10) days of your compliance of the above conditions, Owner will return to you one fully executed counterpart of the Agreement, together with an additional copies of the Contract Documents as indicated in Paragraph 2.02 of the General Conditions.

You are required to return an acknowledged copy of this NOTICE OF AWARD to the OWNER.

Dated this _____ day of _____, 2023.

CITY OF GUTHRIE

Jimmy Covington, Mayor

ACCEPTANCE OF NOTICE

Receipt of the above NOTICE OF AWARD is hereby acknowledged and dated this _____ day of _____ 2023.

(contractor)

Name, Title

4.03 *Liquidated Damages*

- A. Contractor and Owner recognize that time is of the essence as stated in Paragraph 4.01 above and that Owner will suffer financial and other losses if the Work is not completed and Milestones not achieved within the times specified in Paragraph 4.02 above, plus any extensions thereof allowed in accordance with the Contract. The parties also recognize the delays, expense, and difficulties involved in proving in a legal or arbitration proceeding the actual loss suffered by Owner if the Work is not completed on time. Accordingly, instead of requiring any such proof, Owner and Contractor agree that as liquidated damages for delay (but not as a penalty):
1. Substantial Completion: Contractor shall pay Owner **\$500** for each day that expires after the time (as duly adjusted pursuant to the Contract) specified in Paragraph 4.02.A above for Substantial Completion until the Work is substantially complete.
 2. Completion of Remaining Work: After Substantial Completion, if Contractor shall neglect, refuse, or fail to complete the remaining Work within the Contract Times (as duly adjusted pursuant to the Contract) for completion and readiness for final payment, Contractor shall pay Owner **\$500** for each day that expires after such time until the Work is completed and ready for final payment.
 3. Liquidated damages for failing to timely attain Substantial Completion and final completion are not additive and will not be imposed concurrently.

ARTICLE 5 – CONTRACT PRICE

5.01 Owner shall pay Contractor for completion of the Work in accordance with the Contract Documents the amounts that follow, subject to adjustment under the Contract:

- A. For all Work, at the prices stated in Contractor’s Bid, attached hereto as an exhibit.

ARTICLE 6 – PAYMENT PROCEDURES

6.01 *Submittal and Processing of Payments*

- A. Contractor shall submit Applications for Payment in accordance with Article 15 of the General Conditions. Applications for Payment will be processed by Engineer as provided in the General Conditions.

6.02 *Progress Payments; Retainage*

- A. Owner shall make progress payments on account of the Contract Price on the basis of Contractor’s Applications for Payment on or about the **first** day of each month during performance of the Work as provided in Paragraph 6.02.A.1 below, provided that such Applications for Payment have been submitted in a timely manner and otherwise meet the requirements of the Contract. All such payments will be measured by the Schedule of Values established as provided in the General Conditions (and in the case of Unit Price Work based on the number of units completed) or, in the event there is no Schedule of Values, as provided elsewhere in the Contract.
1. Prior to Substantial Completion, progress payments will be made in an amount equal to the percentage indicated below but, in each case, less the aggregate of payments previously made and less such amounts as Owner may withhold, including but not limited to liquidated damages, in accordance with the Contract
 - a. 95 percent of Work completed (with the balance being retainage); and
 - b. 95 percent of cost of materials and equipment not incorporated in the Work (with the balance being retainage).
 2. Upon Substantial Completion of the entire construction to be provided under the Contract Documents..

6.03 *Final Payment*

- A. Upon final completion and acceptance of the Work in accordance with Paragraph 15.06 of the General Conditions, Owner shall pay the remainder of the Contract Price as recommended by Engineer as provided in said Paragraph 15.06.

ARTICLE 7 – INTEREST

7.01 All amounts not paid when due shall bear interest at the maximum legal rate.

ARTICLE 8 – CONTRACTOR’S REPRESENTATIONS

1.02 In order to induce Owner to enter into this Contract, Contractor makes the following representations:

- A. Contractor has examined and carefully studied the Contract Documents, and any data and reference items identified in the Contract Documents.
- B. Contractor has visited the Site, conducted a thorough, alert visual examination of the Site and adjacent areas, and become familiar with and is satisfied as to the general, local, and Site conditions that may affect cost, progress, and performance of the Work.
- C. Contractor is familiar with and is satisfied as to all Laws and Regulations that may affect cost, progress, and performance of the Work.
- D. Contractor has carefully studied all: (1) reports of explorations and tests of subsurface conditions at or adjacent to the Site and all drawings of physical conditions relating to existing surface or subsurface structures at the Site that have been identified in the Supplementary Conditions, especially with respect to Technical Data in such reports and drawings, and (2) reports and drawings relating to Hazardous Environmental Conditions, if any, at or adjacent to the Site that have been identified in the Supplementary Conditions, especially with respect to Technical Data in such reports and drawings.
- E. Contractor has considered the information known to Contractor itself; information commonly known to contractors doing business in the locality of the Site; information and observations obtained from visits to the Site; the Contract Documents; and the Site-related reports and drawings identified in the Contract Documents, with respect to the effect of such information, observations, and documents on (1) the cost, progress, and performance of the Work; (2) the means, methods, techniques, sequences, and procedures of construction to be employed by Contractor; and (3) Contractor’s safety precautions and programs.
- F. Based on the information and observations referred to in the preceding paragraph, Contractor agrees that no further examinations, investigations, explorations, tests, studies, or data are necessary for the performance of the Work at the Contract Price, within the Contract Times, and in accordance with the other terms and conditions of the Contract.
- G. Contractor is aware of the general nature of work to be performed by Owner and others at the Site that relates to the Work as indicated in the Contract Documents.
- H. Contractor has given Engineer written notice of all conflicts, errors, ambiguities, or discrepancies that Contractor has discovered in the Contract Documents, and the written resolution thereof by Engineer is acceptable to Contractor.
- I. The Contract Documents are generally sufficient to indicate and convey understanding of all terms and conditions for performance and furnishing of the Work.
- J. Contractor’s entry into this Contract constitutes an incontrovertible representation by Contractor that without exception all prices in the Agreement are premised upon performing and furnishing the Work required by the Contract Documents.

ARTICLE 9 – CONTRACT DOCUMENTS

9.01 *Contents*

- A. The Contract Documents consist of the following:
1. This Agreement (pages 1 to 6 inclusive).
 2. Performance bond (pages 1 to 3 inclusive).
 3. Payment bond (pages 1 to 3 inclusive).
 4. Bid bonds (pages 1 to 2 inclusive).
 5. General Conditions (pages 1 to 66 inclusive).
 6. Supplementary Conditions (pages 1 to 3 inclusive).
 7. Specifications as listed in the table of contents of the Project Manual.
 8. Drawings & Exhibits consisting of 1 sheet bearing the following general title: City-wide Meter Change Out Project
 9. Addenda (numbers * to *, inclusive).
 10. Exhibits to this Agreement (enumerated as follows):
 - a. Contractor’s Bid (pages 1 to 6 inclusive).
 - b. Documents submitted by Contractor prior to Notice of Award – Statement of Experience.
 11. The following which may be delivered or issued on or after the Effective Date of the Agreement and are not attached hereto:
 - a. Notice to Proceed (pages 1 to 1, inclusive).
 - b. Work Change Directives.
 - c. Change Order(s).
- B. The documents listed in Paragraph 9.01.A are attached to this Agreement (except as expressly noted otherwise above).
- C. There are no Contract Documents other than those listed above in this Article 9.
- D. The Contract Documents may only be amended, modified, or supplemented as provided in the General Conditions.

ARTICLE 10 – MISCELLANEOUS

10.01 *Terms*

- A. Terms used in this Agreement will have the meanings stated in the General Conditions and the Supplementary Conditions.

10.02 *Assignment of Contract*

- A. Unless expressly agreed to elsewhere in the Contract, no assignment by a party hereto of any rights under or interests in the Contract will be binding on another party hereto without the written consent of the party sought to be bound; and, specifically but without limitation, money that may become due and money that is due may not be assigned without such consent (except to the extent that the effect of this restriction may be limited by law), and unless specifically stated to the contrary in any written consent to an assignment, no assignment will release or discharge the assignor from any duty or responsibility under the Contract Documents.

10.03 *Successors and Assigns*

- A. Owner and Contractor each binds itself, its successors, assigns, and legal representatives to the other party hereto, its successors, assigns, and legal representatives in respect to all covenants, agreements, and obligations contained in the Contract Documents.

10.04 *Severability*

- A. Any provision or part of the Contract Documents held to be void or unenforceable under any Law or Regulation shall be deemed stricken, and all remaining provisions shall continue to be valid and binding upon Owner and Contractor, who agree that the Contract Documents shall be reformed to replace such stricken provision or part thereof with a valid and enforceable provision that comes as close as possible to expressing the intention of the stricken provision.

10.05 *Contractor's Certifications*

- A. Contractor certifies that it has not engaged in corrupt, fraudulent, collusive, or coercive practices in competing for or in executing the Contract. For the purposes of this Paragraph 10.05:
 - 1. "corrupt practice" means the offering, giving, receiving, or soliciting of any thing of value likely to influence the action of a public official in the bidding process or in the Contract execution;
 - 2. "fraudulent practice" means an intentional misrepresentation of facts made (a) to influence the bidding process or the execution of the Contract to the detriment of Owner, (b) to establish Bid or Contract prices at artificial non-competitive levels, or (c) to deprive Owner of the benefits of free and open competition;
 - 3. "collusive practice" means a scheme or arrangement between two or more Bidders, with or without the knowledge of Owner, a purpose of which is to establish Bid prices at artificial, non-competitive levels; and
 - 4. "coercive practice" means harming or threatening to harm, directly or indirectly, persons or their property to influence their participation in the bidding process or affect the execution of the Contract.

10.06 *Other Provisions*

- A. Owner stipulates that if the General Conditions that are made a part of this Contract are based on EJCDC® C-700, Standard General Conditions for the Construction Contract, published by the Engineers Joint Contract Documents Committee®, and if Owner is the party that has furnished said General Conditions, then Owner has plainly shown all modifications to the standard wording of such published document to the Contractor in the Supplementary Conditions.

IN WITNESS WHEREOF, Owner and Contractor have signed this Agreement.

This Agreement will be effective on _____ (which is the Effective Date of the Contract).

OWNER:

CONTRACTOR

City of Guthrie Water & Sewer

By: _____

By: _____

Title: **Jimmy Covington, Mayor**

Title: _____

[CORPORATE SEAL]

[CORPORATE SEAL]

Attest: _____

Attest: _____

Title: **Alison Blumel, City Clerk**

Title: _____

Address for giving notices:

Address for giving notices:

PO Box 125

Guthrie, KY 42234

License No. (where applicable):

(If Owner is a corporation, attach evidence of authority to sign. If Owner is a public body, attach evidence of authority to sign and resolution or other documents authorizing execution of this Agreement.)

NOTE TO USER: Use in those states or other jurisdictions where applicable or required.

PERFORMANCE BOND

Any singular reference to Contractor, Surety, Owner, or other party shall be considered plural where applicable.

CONTRACTOR (*Name and Address*): SURETY (*Name, and Address of Principal Place of Business*):

OWNER (*Name and Address*):

City of Guthrie
PO Box 125
Guthrie, KY 42234

CONTRACT

Effective Date of Agreement:
Amount:
Description (*Name and Location*):

BOND

Bond Number:
Date (*Not earlier than Effective Date of Agreement*):
Amount:
Modifications to this Bond Form:

Surety and Contractor, intending to be legally bound hereby, subject to the terms set forth below, do each cause this Performance Bond to be duly executed by an authorized officer, agent, or representative.

CONTRACTOR AS PRINCIPAL

SURETY

Contractor's Name and Corporate Seal (Seal)

Surety's Name and Corporate Seal (Seal)

By: _____
Signature

By: _____
Signature (Attach Power of Attorney)

Print Name

Print Name

Title

Title

Attest: _____
Signature

Attest: _____
Signature

Title

Title

Note: Provide execution by additional parties, such as joint ventures, if necessary.

Contractor and Surety, jointly and severally, bind themselves, their heirs, executors, administrators, successors, and assigns to Owner for the performance of the Contract, which is incorporated herein by reference.

1. If Contractor performs the Contract, Surety and Contractor have no obligation under this Bond, except to participate in conferences as provided in Paragraph 2.1.
2. If there is no Owner Default, Surety's obligation under this Bond shall arise after:
 - 2.1 Owner has notified Contractor and Surety, at the addresses described in Paragraph 9 below, that Owner is considering declaring a Contractor Default and has requested and attempted to arrange a conference with Contractor and Surety to be held not later than 15 days after receipt of such notice to discuss methods of performing the Contract. If Owner, Contractor, and Surety agree, Contractor shall be allowed a reasonable time to perform the Contract, but such an agreement shall not waive Owner's right, if any, subsequently to declare a Contractor Default; and
 - 2.2 Owner has declared a Contractor Default and formally terminated Contractor's right to complete the Contract. Such Contractor Default shall not be declared earlier than 20 days after Contractor and Surety have received notice as provided in Paragraph 2.1; and
 - 2.3 Owner has agreed to pay the Balance of the Contract Price to:
 1. Surety in accordance with the terms of the Contract; or
 2. Another contractor selected pursuant to Paragraph 3.3 to perform the Contract.
3. When Owner has satisfied the conditions of Paragraph 2, Surety shall promptly, and at Surety's expense, take one of the following actions:
 - 3.1 Arrange for Contractor, with consent of Owner, to perform and complete the Contract; or
 - 3.2 Undertake to perform and complete the Contract itself, through its agents or through independent contractors; or
 - 3.3 Obtain bids or negotiated proposals from qualified contractors acceptable to Owner for a contract for performance and completion of the Contract, arrange for a contract to be prepared for execution by Owner and contractor selected with Owner's concurrence, to be secured with performance and payment bonds executed by a qualified surety equivalent to the bonds issued on the Contract, and pay to Owner the amount of damages as described in Paragraph 5 in excess of the Balance of the Contract Price incurred by Owner resulting from Contractor Default; or
 - 3.4 Waive its right to perform and complete, arrange for completion, or obtain a new contractor, and with reasonable promptness under the circumstances:
 1. After investigation, determine the amount for which it may be liable to Owner and, as soon as practicable after the amount is determined, tender payment therefor to Owner; or
 2. Deny liability in whole or in part and notify Owner citing reasons therefore.
4. If Surety does not proceed as provided in Paragraph 3 with reasonable promptness, Surety shall be deemed to be in default on this Bond 15 days after receipt of an additional written notice from Owner to Surety demanding that Surety perform its obligations under this Bond, and Owner shall be entitled to enforce any remedy available to Owner. If Surety proceeds as provided in Paragraph 3.4, and Owner refuses the payment tendered or Surety has denied liability, in whole or in part, without further notice Owner shall be entitled to enforce any remedy available to Owner.
5. After Owner has terminated Contractor's right to complete the Contract, and if Surety elects to act under Paragraph 3.1, 3.2, or 3.3 above, then the responsibilities of Surety to Owner shall not be greater than those of Contractor under the Contract, and the responsibilities of Owner to Surety shall not be greater than those of Owner under the Contract. To the limit of the amount of this Bond, but subject to commitment by Owner of the Balance of the Contract Price to mitigation of costs and damages on the Contract, Surety is obligated without duplication for:

- 5.1 The responsibilities of Contractor for correction of defective Work and completion of the Contract;
- 5.2 Additional legal, design professional, and delay costs resulting from Contractor's Default, and resulting from the actions of or failure to act of Surety under Paragraph 3; and
- 5.3 Liquidated damages, or if no liquidated damages are specified in the Contract, actual damages caused by delayed performance or non-performance of Contractor.

6. Surety shall not be liable to Owner or others for obligations of Contractor that are unrelated to the Contract, and the Balance of the Contract Price shall not be reduced or set off on account of any such unrelated obligations. No right of action shall accrue on this Bond to any person or entity other than Owner or its heirs, executors, administrators, or successors.

7. Surety hereby waives notice of any change, including changes of time, to Contract or to related subcontracts, purchase orders, and other obligations.

8. Any proceeding, legal or equitable, under this Bond may be instituted in any court of competent jurisdiction in the location in which the Work or part of the Work is located, and shall be instituted within two years after Contractor Default or within two years after Contractor ceased working or within two years after Surety refuses or fails to perform its obligations under this Bond, whichever occurs first. If the provisions of this paragraph are void or prohibited by law, the minimum period of limitation available to sureties as a defense in the jurisdiction of the suit shall be applicable.

9. Notice to Surety, Owner, or Contractor shall be mailed or delivered to the address shown on the signature page.

10. When this Bond has been furnished to comply with a statutory requirement in the location where the Contract was to be performed, any provision in this Bond conflicting with said statutory requirement shall be deemed deleted herefrom and provisions conforming to such statutory requirement shall be deemed incorporated herein. The intent is that this Bond shall be construed as a statutory bond and not as a common law bond.

11. Definitions.

- 11.1 Balance of the Contract Price: The total amount payable by Owner to Contractor under the Contract after all proper adjustments have been made, including allowance to Contractor of any amounts received or to be received by Owner in settlement of insurance or other Claims for damages to which Contractor is entitled, reduced by all valid and proper payments made to or on behalf of Contractor under the Contract.
- 11.2 Contract: The agreement between Owner and Contractor identified on the signature page, including all Contract Documents and changes thereto.
- 11.3 Contractor Default: Failure of Contractor, which has neither been remedied nor waived, to perform or otherwise to comply with the terms of the Contract.
- 11.4 Owner Default: Failure of Owner, which has neither been remedied nor waived, to pay Contractor as required by the Contract or to perform and complete or otherwise comply with the other terms thereof.

FOR INFORMATION ONLY – *(Name, Address and Telephone)*
Surety Agency or Broker:
Owner's Representative *(Engineer or other party)*:

PAYMENT BOND

Any singular reference to Contractor, Surety, Owner, or other party shall be considered plural where applicable.

CONTRACTOR (*Name and Address*):

SURETY (*Name, and Address of Principal Place of Business*):

OWNER (*Name and Address*):

City of Guthrie
PO Box 125
Guthrie, KY 42234

CONTRACT

Effective Date of Agreement:

Amount:

Description (*Name and Location*):

BOND

Bond Number:

Date (*Not earlier than Effective Date of Agreement*):

Amount:

Modifications to this Bond Form:

Surety and Contractor, intending to be legally bound hereby, subject to the terms set forth below, do each cause this Payment Bond to be duly executed by an authorized officer, agent, or representative.

CONTRACTOR AS PRINCIPAL

SURETY

Contractor's Name and Corporate Seal (Seal)

Surety's Name and Corporate Seal (Seal)

By: _____
Signature

By: _____
Signature (Attach Power of Attorney)

Print Name

Print Name

Title

Title

Attest: _____
Signature

Attest: _____
Signature

Title

Title

Note: Provide execution by additional parties, such as joint ventures, if necessary.

1. Contractor and Surety, jointly and severally, bind themselves, their heirs, executors, administrators, successors, and assigns to Owner to pay for labor, materials, and equipment furnished by Claimants for use in the performance of the Contract, which is incorporated herein by reference.
2. With respect to Owner, this obligation shall be null and void if Contractor:
 - 2.1 Promptly makes payment, directly or indirectly, for all sums due Claimants, and
 - 2.2 Defends, indemnifies, and holds harmless Owner from all claims, demands, liens, or suits alleging non-payment by Contractor by any person or entity who furnished labor, materials, or equipment for use in the performance of the Contract, provided Owner has promptly notified Contractor and Surety (at the addresses described in Paragraph 12) of any claims, demands, liens, or suits and tendered defense of such claims, demands, liens, or suits to Contractor and Surety, and provided there is no Owner Default.
3. With respect to Claimants, this obligation shall be null and void if Contractor promptly makes payment, directly or indirectly, for all sums due.
4. Surety shall have no obligation to Claimants under this Bond until:
 - 4.1 Claimants who are employed by or have a direct contract with Contractor have given notice to Surety (at the address described in Paragraph 12) and sent a copy, or notice thereof, to Owner, stating that a claim is being made under this Bond and, with substantial accuracy, the amount of the claim.
 - 4.2 Claimants who do not have a direct contract with Contractor:
 1. Have furnished written notice to Contractor and sent a copy, or notice thereof, to Owner, within 90 days after having last performed labor or last furnished materials or equipment included in the claim stating, with substantial accuracy, the amount of the claim and the name of the party to whom the materials or equipment were furnished or supplied, or for whom the labor was done or performed; and
 2. Have either received a rejection in whole or in part from Contractor, or not received within 30 days of furnishing the above notice any communication from Contractor by which Contractor had indicated the claim will be paid directly or indirectly; and
 3. Not having been paid within the above 30 days, have sent a written notice to Surety (at the address described in Paragraph 12) and sent a copy, or notice thereof, to Owner, stating that a claim is being made under this Bond and enclosing a copy of the previous written notice furnished to Contractor.
5. If a notice by a Claimant required by Paragraph 4 is provided by Owner to Contractor or to Surety, that is sufficient compliance.
6. Reserved.
7. Surety's total obligation shall not exceed the amount of this Bond, and the amount of this Bond shall be credited for any payments made in good faith by Surety.
8. Amounts owed by Owner to Contractor under the Contract shall be used for the performance of the Contract and to satisfy claims, if any, under any performance bond. By Contractor furnishing and Owner accepting this Bond, they agree that all funds earned by Contractor in the performance of the Contract are dedicated to satisfy obligations of Contractor and Surety under this Bond, subject to Owner's priority to use the funds for the completion of the Work.
9. Surety shall not be liable to Owner, Claimants, or others for obligations of Contractor that are unrelated to the Contract. Owner shall not be liable for payment of any costs or expenses of any Claimant under this Bond, and shall have under this Bond no obligations to make payments to, give notices on behalf of, or otherwise have obligations to Claimants under this Bond.

10. Surety hereby waives notice of any change, including changes of time, to the Contract or to related subcontracts, purchase orders, and other obligations.

11. No suit or action shall be commenced by a Claimant under this Bond other than in a court of competent jurisdiction in the location in which the Work or part of the Work is located or after the expiration of one year from the date (1) on which the Claimant gave the notice required by Paragraph 4.1 or Paragraph 4.2.3, or (2) on which the last labor or service was performed by anyone or the last materials or equipment were furnished by anyone under the Contract, whichever of (1) or (2) first occurs. If the provisions of this paragraph are void or prohibited by law, the minimum period of limitation available to sureties as a defense in the jurisdiction of the suit shall be applicable.

12. Notice to Surety, Owner, or Contractor shall be mailed or delivered to the addresses shown on the signature page. Actual receipt of notice by Surety, Owner, or Contractor, however accomplished, shall be sufficient compliance as of the date received at the address shown on the signature page.

13. When this Bond has been furnished to comply with a statutory requirement in the location where the Contract was to be performed, any provision in this Bond conflicting with said statutory requirement shall be deemed deleted herefrom and provisions conforming to such statutory requirement shall be deemed incorporated herein. The intent is that this Bond shall be construed as a statutory Bond and not as a common law bond.

14. Upon request of any person or entity appearing to be a potential beneficiary of this Bond, Contractor shall promptly furnish a copy of this Bond or shall permit a copy to be made.

15. Definitions

15.1 Claimant: An individual or entity having a direct contract with Contractor, or with a first-tier subcontractor of Contractor, to furnish labor, materials, or equipment for use in the performance of the Contract. The intent of this Bond shall be to include without limitation in the terms “labor, materials or equipment” that part of water, gas, power, light, heat, oil, gasoline, telephone service, or rental equipment used in the Contract, architectural and engineering services required for performance of the Work of Contractor and Contractor’s subcontractors, and all other items for which a mechanic’s lien may be asserted in the jurisdiction where the labor, materials, or equipment were furnished.

15.2 Contract: The agreement between Owner and Contractor identified on the signature page, including all Contract Documents and changes thereto.

15.3 Owner Default: Failure of Owner, which has neither been remedied nor waived, to pay Contractor as required by the Contract, or to perform and complete or otherwise comply with the other terms thereof.

FOR INFORMATION ONLY – *(Name, Address, and Telephone)*

Surety Agency or Broker:

Owner’s Representative *(Engineer or other)*:

NOTICE TO PROCEED

TO: _____

DATE: _____

PROJECT: **City of Guthrie, Kentucky**
City-wide Meter Change Out Project

You are hereby notified to commence WORK in accordance with the Agreement dated _____ on or before _____. You are to substantially complete the WORK within **90** consecutive calendar days thereafter. The required date of substantial completion of the WORK is therefore _____. You are also required to fully complete all WORK within **120** consecutive calendar days. The required date of final completion is therefore _____.

CITY OF GUTHRIE, KENTUCKY

Jimmy Covington, Mayor

ACCEPTANCE OF NOTICE

Receipt of the above NOTICE TO PROCEED is hereby acknowledged and dated this ____ day of _____ 2023.

(CONTRACTOR)

Name, Title

Employer Identification Number

This document has important legal consequences; consultation with an attorney is encouraged with respect to its use or modification. This document should be adapted to the particular circumstances of the contemplated Project and the controlling Laws and Regulations.

STANDARD GENERAL CONDITIONS OF THE CONSTRUCTION CONTRACT

Prepared by



Issued and Published Jointly by



Endorsed by



These General Conditions have been prepared for use with the Agreement Between Owner and Contractor for Construction Contract (EJCDC® C-520, Stipulated Sum, or C-525, Cost-Plus, 2013 Editions). Their provisions are interrelated and a change in one may necessitate a change in the other.

To prepare supplementary conditions that are coordinated with the General Conditions, use EJCDC's Guide to the Preparation of Supplementary Conditions (EJCDC® C-800, 2013 Edition). The full EJCDC Construction series of documents is discussed in the Commentary on the 2013 EJCDC Construction Documents (EJCDC® C-001, 2013 Edition).

Copyright © 2013:

National Society of Professional Engineers
1420 King Street, Alexandria, VA 22314-2794
(703) 684-2882
www.nspe.org

American Council of Engineering Companies
1015 15th Street N.W., Washington, DC 20005
(202) 347-7474
www.acec.org

American Society of Civil Engineers
1801 Alexander Bell Drive, Reston, VA 20191-4400
(800) 548-2723
www.asce.org

The copyright for this document is owned jointly by the three sponsoring organizations listed above. The National Society of Professional Engineers is the Copyright Administrator for the EJCDC documents; please direct all inquiries regarding EJCDC copyrights to NSPE.

NOTE: EJCDC publications may be purchased at www.ejcdc.org, or from any of the sponsoring organizations above

**STANDARD GENERAL CONDITIONS OF THE
CONSTRUCTION CONTRACT**

TABLE OF CONTENTS

	Page
ARTICLE 1 – Definitions and Terminology.....	7
1.01 Defined Terms	7
1.02 Terminology.....	10
ARTICLE 2 – Preliminary Matters	11
2.01 Delivery of Bonds and Evidence of Insurance	11
2.02 Copies of Documents.....	12
2.03 Before Starting Construction	12
2.04 Preconstruction Conference; Designation of Authorized Representatives.....	12
2.05 Initial Acceptance of Schedules	12
2.06 Electronic Transmittals	13
ARTICLE 3 – Documents: Intent, Requirements, Reuse.....	13
3.01 Intent	13
3.02 Reference Standards.....	13
3.03 Reporting and Resolving Discrepancies.....	14
3.04 Requirements of the Contract Documents.....	15
3.05 Reuse of Documents.....	15
ARTICLE 4 – Commencement and Progress of the Work	15
4.01 Commencement of Contract Times; Notice to Proceed.....	15
4.02 Starting the Work	15
4.03 Reference Points.....	16
4.04 Progress Schedule.....	16
4.05 Delays in Contractor’s Progress.....	16
ARTICLE 5 – Availability of Lands; Subsurface and Physical Conditions; Hazardous Environmental Conditions	17
5.01 Availability of Lands	17
5.02 Use of Site and Other Areas	17
5.03 Subsurface and Physical Conditions	18
5.04 Differing Subsurface or Physical Conditions.....	19
5.05 Underground Facilities	20
5.06 Hazardous Environmental Conditions at Site	21

ARTICLE 6 – Bonds and Insurance.....	23
6.01 Performance, Payment, and Other Bonds.....	23
6.02 Insurance—General Provisions.....	24
6.03 Contractor’s Insurance	25
6.04 Owner’s Liability Insurance.....	27
6.05 Property Insurance	27
6.06 Waiver of Rights.....	29
6.07 Receipt and Application of Property Insurance Proceeds	30
ARTICLE 7 – Contractor’s Responsibilities	30
7.01 Supervision and Superintendence.....	30
7.02 Labor; Working Hours.....	30
7.03 Services, Materials, and Equipment	30
7.04 “Or Equals”	31
7.05 Substitutes	32
7.06 Concerning Subcontractors, Suppliers, and Others.....	33
7.07 Patent Fees and Royalties.....	34
7.08 Permits.....	35
7.09 Taxes	35
7.10 Laws and Regulations	35
7.11 Record Documents	36
7.12 Safety and Protection	36
7.13 Safety Representative.....	37
7.14 Hazard Communication Programs.....	37
7.15 Emergencies.....	37
7.16 Shop Drawings, Samples, and Other Submittals	37
7.17 Contractor’s General Warranty and Guarantee	39
7.18 Indemnification.....	40
7.19 Delegation of Professional Design Services.....	40
ARTICLE 8 – Other Work at the Site.....	41
8.01 Other Work.....	41
8.02 Coordination	41
8.03 Legal Relationships	42
ARTICLE 9 – Owner’s Responsibilities	42
9.01 Communications to Contractor	42
9.02 Replacement of Engineer	43

9.03	Furnish Data.....	43
9.04	Pay When Due	43
9.05	Lands and Easements; Reports, Tests, and Drawings.....	43
9.06	Insurance	43
9.07	Change Orders	43
9.08	Inspections, Tests, and Approvals	43
9.09	Limitations on Owner’s Responsibilities.....	43
9.10	Undisclosed Hazardous Environmental Condition	43
9.11	Evidence of Financial Arrangements	43
9.12	Safety Programs.....	43
ARTICLE 10 – Engineer’s Status During Construction		44
10.01	Owner’s Representative	44
10.02	Visits to Site	44
10.03	Project Representative	44
10.04	Rejecting Defective Work	44
10.05	Shop Drawings, Change Orders and Payments	44
10.06	Determinations for Unit Price Work.....	45
10.07	Decisions on Requirements of Contract Documents and Acceptability of Work.....	45
10.08	Limitations on Engineer’s Authority and Responsibilities	45
10.09	Compliance with Safety Program	45
ARTICLE 11 – Amending the Contract Documents; Changes in the Work.....		45
11.01	Amending and Supplementing Contract Documents.....	45
11.02	Owner-Authorized Changes in the Work.....	46
11.03	Unauthorized Changes in the Work	46
11.04	Change of Contract Price	47
11.05	Change of Contract Times	48
11.06	Change Proposals	48
11.07	Execution of Change Orders	48
11.08	Notification to Surety	49
ARTICLE 12 – Claims		49
12.01	Claims.....	49
ARTICLE 13 – Cost of the Work; Allowances; Unit Price Work		50
13.01	Cost of the Work.....	50
13.02	Allowances.....	52
13.03	Unit Price Work.....	53

ARTICLE 14 – Tests and Inspections; Correction, Removal or Acceptance of Defective Work	53
14.01 Access to Work	53
14.02 Tests, Inspections, and Approvals	54
14.03 Defective Work	54
14.04 Acceptance of Defective Work	55
14.05 Uncovering Work.....	55
14.06 Owner May Stop the Work.....	56
14.07 Owner May Correct Defective Work	56
ARTICLE 15 – Payments to Contractor; Set-Offs; Completion; Correction Period	56
15.01 Progress Payments	56
15.02 Contractor’s Warranty of Title.....	59
15.03 Substantial Completion	59
15.04 Partial Use or Occupancy.....	60
15.05 Final Inspection.....	61
15.06 Final Payment	61
15.07 Waiver of Claims.....	62
15.08 Correction Period.....	62
ARTICLE 16 – Suspension of Work and Termination	63
16.01 Owner May Suspend Work.....	63
16.02 Owner May Terminate for Cause	63
16.03 Owner May Terminate For Convenience.....	64
16.04 Contractor May Stop Work or Terminate.....	64
ARTICLE 17 – Final Resolution of Disputes	65
17.01 Methods and Procedures	65
ARTICLE 18 – Miscellaneous	65
18.01 Giving Notice.....	65
18.02 Computation of Times	65
18.03 Cumulative Remedies	65
18.04 Limitation of Damages.....	65
18.05 No Waiver	66
18.06 Survival of Obligations	66
18.07 Controlling Law	66
18.08 Headings	66

ARTICLE 1 – DEFINITIONS AND TERMINOLOGY

1.01 *Defined Terms*

- A. Wherever used in the Bidding Requirements or Contract Documents, a term printed with initial capital letters, including the term's singular and plural forms, will have the meaning indicated in the definitions below. In addition to terms specifically defined, terms with initial capital letters in the Contract Documents include references to identified articles and paragraphs, and the titles of other documents or forms.
1. *Addenda*—Written or graphic instruments issued prior to the opening of Bids which clarify, correct, or change the Bidding Requirements or the proposed Contract Documents.
 2. *Agreement*—The written instrument, executed by Owner and Contractor, that sets forth the Contract Price and Contract Times, identifies the parties and the Engineer, and designates the specific items that are Contract Documents.
 3. *Application for Payment*—The form acceptable to Engineer which is to be used by Contractor during the course of the Work in requesting progress or final payments and which is to be accompanied by such supporting documentation as is required by the Contract Documents.
 4. *Bid*—The offer of a Bidder submitted on the prescribed form setting forth the prices for the Work to be performed.
 5. *Bidder*—An individual or entity that submits a Bid to Owner.
 6. *Bidding Documents*—The Bidding Requirements, the proposed Contract Documents, and all Addenda.
 7. *Bidding Requirements*—The advertisement or invitation to bid, Instructions to Bidders, Bid Bond or other Bid security, if any, the Bid Form, and the Bid with any attachments.
 8. *Change Order*—A document which is signed by Contractor and Owner and authorizes an addition, deletion, or revision in the Work or an adjustment in the Contract Price or the Contract Times, or other revision to the Contract, issued on or after the Effective Date of the Contract.
 9. *Change Proposal*—A written request by Contractor, duly submitted in compliance with the procedural requirements set forth herein, seeking an adjustment in Contract Price or Contract Times, or both; contesting an initial decision by Engineer concerning the requirements of the Contract Documents or the acceptability of Work under the Contract Documents; challenging a set-off against payments due; or seeking other relief with respect to the terms of the Contract.
 10. *Claim*—(a) A demand or assertion by Owner directly to Contractor, duly submitted in compliance with the procedural requirements set forth herein: seeking an adjustment of Contract Price or Contract Times, or both; contesting an initial decision by Engineer concerning the requirements of the Contract Documents or the acceptability of Work under the Contract Documents; contesting Engineer's decision regarding a Change Proposal; seeking resolution of a contractual issue that Engineer has declined to address; or seeking other relief with respect to the terms of the Contract; or (b) a demand or assertion by Contractor directly to Owner, duly submitted in compliance with the procedural requirements set forth herein, contesting Engineer's decision regarding a Change Proposal; or seeking resolution of a contractual issue that Engineer has declined to address. A demand for money or services by a third party is not a Claim.
 11. *Constituent of Concern*—Asbestos, petroleum, radioactive materials, polychlorinated biphenyls (PCBs), hazardous waste, and any substance, product, waste, or other material of any nature

whatsoever that is or becomes listed, regulated, or addressed pursuant to (a) the Comprehensive Environmental Response, Compensation and Liability Act, 42 U.S.C. §§9601 et seq. (“CERCLA”); (b) the Hazardous Materials Transportation Act, 49 U.S.C. §§5101 et seq.; (c) the Resource Conservation and Recovery Act, 42 U.S.C. §§6901 et seq. (“RCRA”); (d) the Toxic Substances Control Act, 15 U.S.C. §§2601 et seq.; (e) the Clean Water Act, 33 U.S.C. §§1251 et seq.; (f) the Clean Air Act, 42 U.S.C. §§7401 et seq.; or (g) any other federal, state, or local statute, law, rule, regulation, ordinance, resolution, code, order, or decree regulating, relating to, or imposing liability or standards of conduct concerning, any hazardous, toxic, or dangerous waste, substance, or material.

12. *Contract*—The entire and integrated written contract between the Owner and Contractor concerning the Work.
13. *Contract Documents*—Those items so designated in the Agreement, and which together comprise the Contract.
14. *Contract Price*—The money that Owner has agreed to pay Contractor for completion of the Work in accordance with the Contract Documents. .
15. *Contract Times*—The number of days or the dates by which Contractor shall: (a) achieve Milestones, if any; (b) achieve Substantial Completion; and (c) complete the Work.
16. *Contractor*—The individual or entity with which Owner has contracted for performance of the Work.
17. *Cost of the Work*—See Paragraph 13.01 for definition.
18. *Drawings*—The part of the Contract that graphically shows the scope, extent, and character of the Work to be performed by Contractor.
19. *Effective Date of the Contract*—The date, indicated in the Agreement, on which the Contract becomes effective.
20. *Engineer*—The individual or entity named as such in the Agreement.
21. *Field Order*—A written order issued by Engineer which requires minor changes in the Work but does not change the Contract Price or the Contract Times.
22. *Hazardous Environmental Condition*—The presence at the Site of Constituents of Concern in such quantities or circumstances that may present a danger to persons or property exposed thereto. The presence at the Site of materials that are necessary for the execution of the Work, or that are to be incorporated in the Work, and that are controlled and contained pursuant to industry practices, Laws and Regulations, and the requirements of the Contract, does not establish a Hazardous Environmental Condition.
23. *Laws and Regulations; Laws or Regulations*—Any and all applicable laws, statutes, rules, regulations, ordinances, codes, and orders of any and all governmental bodies, agencies, authorities, and courts having jurisdiction.
24. *Liens*—Charges, security interests, or encumbrances upon Contract-related funds, real property, or personal property.
25. *Milestone*—A principal event in the performance of the Work that the Contract requires Contractor to achieve by an intermediate completion date or by a time prior to Substantial Completion of all the Work.
26. *Notice of Award*—The written notice by Owner to a Bidder of Owner’s acceptance of the Bid.

27. *Notice to Proceed*—A written notice by Owner to Contractor fixing the date on which the Contract Times will commence to run and on which Contractor shall start to perform the Work.
28. *Owner*—The individual or entity with which Contractor has contracted regarding the Work, and which has agreed to pay Contractor for the performance of the Work, pursuant to the terms of the Contract.
29. *Progress Schedule*—A schedule, prepared and maintained by Contractor, describing the sequence and duration of the activities comprising the Contractor’s plan to accomplish the Work within the Contract Times.
30. *Project*—The total undertaking to be accomplished for Owner by engineers, contractors, and others, including planning, study, design, construction, testing, commissioning, and start-up, and of which the Work to be performed under the Contract Documents is a part.
31. *Project Manual*—The written documents prepared for, or made available for, procuring and constructing the Work, including but not limited to the Bidding Documents or other construction procurement documents, geotechnical and existing conditions information, the Agreement, bond forms, General Conditions, Supplementary Conditions, and Specifications. The contents of the Project Manual may be bound in one or more volumes.
32. *Resident Project Representative*—The authorized representative of Engineer assigned to assist Engineer at the Site. As used herein, the term Resident Project Representative or “RPR” includes any assistants or field staff of Resident Project Representative.
33. *Samples*—Physical examples of materials, equipment, or workmanship that are representative of some portion of the Work and that establish the standards by which such portion of the Work will be judged.
34. *Schedule of Submittals*—A schedule, prepared and maintained by Contractor, of required submittals and the time requirements for Engineer’s review of the submittals and the performance of related construction activities.
35. *Schedule of Values*—A schedule, prepared and maintained by Contractor, allocating portions of the Contract Price to various portions of the Work and used as the basis for reviewing Contractor’s Applications for Payment.
36. *Shop Drawings*—All drawings, diagrams, illustrations, schedules, and other data or information that are specifically prepared or assembled by or for Contractor and submitted by Contractor to illustrate some portion of the Work. Shop Drawings, whether approved or not, are not Drawings and are not Contract Documents.
37. *Site*—Lands or areas indicated in the Contract Documents as being furnished by Owner upon which the Work is to be performed, including rights-of-way and easements, and such other lands furnished by Owner which are designated for the use of Contractor.
38. *Specifications*—The part of the Contract that consists of written requirements for materials, equipment, systems, standards, and workmanship as applied to the Work, and certain administrative requirements and procedural matters applicable to the Work.
39. *Subcontractor*—An individual or entity having a direct contract with Contractor or with any other Subcontractor for the performance of a part of the Work.
40. *Substantial Completion*—The time at which the Work (or a specified part thereof) has progressed to the point where, in the opinion of Engineer, the Work (or a specified part thereof) is sufficiently complete, in accordance with the Contract Documents, so that the Work (or a specified part thereof) can be utilized for the purposes for which it is intended. The terms

“substantially complete” and “substantially completed” as applied to all or part of the Work refer to Substantial Completion thereof.

41. *Successful Bidder*—The Bidder whose Bid the Owner accepts, and to which the Owner makes an award of contract, subject to stated conditions.
42. *Supplementary Conditions*—The part of the Contract that amends or supplements these General Conditions.
43. *Supplier*—A manufacturer, fabricator, supplier, distributor, materialman, or vendor having a direct contract with Contractor or with any Subcontractor to furnish materials or equipment to be incorporated in the Work by Contractor or a Subcontractor.
44. *Technical Data*—Those items expressly identified as Technical Data in the Supplementary Conditions, with respect to either (a) subsurface conditions at the Site, or physical conditions relating to existing surface or subsurface structures at the Site (except Underground Facilities) or (b) Hazardous Environmental Conditions at the Site. If no such express identifications of Technical Data have been made with respect to conditions at the Site, then the data contained in boring logs, recorded measurements of subsurface water levels, laboratory test results, and other factual, objective information regarding conditions at the Site that are set forth in any geotechnical or environmental report prepared for the Project and made available to Contractor are hereby defined as Technical Data with respect to conditions at the Site under Paragraphs 5.03, 5.04, and 5.06.
45. *Underground Facilities*—All underground pipelines, conduits, ducts, cables, wires, manholes, vaults, tanks, tunnels, or other such facilities or attachments, and any encasements containing such facilities, including but not limited to those that convey electricity, gases, steam, liquid petroleum products, telephone or other communications, fiber optic transmissions, cable television, water, wastewater, storm water, other liquids or chemicals, or traffic or other control systems.
46. *Unit Price Work*—Work to be paid for on the basis of unit prices.
47. *Work*—The entire construction or the various separately identifiable parts thereof required to be provided under the Contract Documents. Work includes and is the result of performing or providing all labor, services, and documentation necessary to produce such construction; furnishing, installing, and incorporating all materials and equipment into such construction; and may include related services such as testing, start-up, and commissioning, all as required by the Contract Documents.
48. *Work Change Directive*—A written directive to Contractor issued on or after the Effective Date of the Contract, signed by Owner and recommended by Engineer, ordering an addition, deletion, or revision in the Work.

1.02 Terminology

- A. The words and terms discussed in the following paragraphs are not defined but, when used in the Bidding Requirements or Contract Documents, have the indicated meaning.
- B. *Intent of Certain Terms or Adjectives*:
 1. The Contract Documents include the terms “as allowed,” “as approved,” “as ordered,” “as directed” or terms of like effect or import to authorize an exercise of professional judgment by Engineer. In addition, the adjectives “reasonable,” “suitable,” “acceptable,” “proper,” “satisfactory,” or adjectives of like effect or import are used to describe an action or determination of Engineer as to the Work. It is intended that such exercise of professional judgment, action, or determination will be solely to evaluate, in general, the Work for

compliance with the information in the Contract Documents and with the design concept of the Project as a functioning whole as shown or indicated in the Contract Documents (unless there is a specific statement indicating otherwise). The use of any such term or adjective is not intended to and shall not be effective to assign to Engineer any duty or authority to supervise or direct the performance of the Work, or any duty or authority to undertake responsibility contrary to the provisions of Article 10 or any other provision of the Contract Documents.

C. *Day:*

1. The word “day” means a calendar day of 24 hours measured from midnight to the next midnight.

D. *Defective:*

1. The word “defective,” when modifying the word “Work,” refers to Work that is unsatisfactory, faulty, or deficient in that it:
 - a. does not conform to the Contract Documents; or
 - b. does not meet the requirements of any applicable inspection, reference standard, test, or approval referred to in the Contract Documents; or
 - c. has been damaged prior to Engineer’s recommendation of final payment (unless responsibility for the protection thereof has been assumed by Owner at Substantial Completion in accordance with Paragraph 15.03 or 15.04).

E. *Furnish, Install, Perform, Provide:*

1. The word “furnish,” when used in connection with services, materials, or equipment, shall mean to supply and deliver said services, materials, or equipment to the Site (or some other specified location) ready for use or installation and in usable or operable condition.
2. The word “install,” when used in connection with services, materials, or equipment, shall mean to put into use or place in final position said services, materials, or equipment complete and ready for intended use.
3. The words “perform” or “provide,” when used in connection with services, materials, or equipment, shall mean to furnish and install said services, materials, or equipment complete and ready for intended use.
4. If the Contract Documents establish an obligation of Contractor with respect to specific services, materials, or equipment, but do not expressly use any of the four words “furnish,” “install,” “perform,” or “provide,” then Contractor shall furnish and install said services, materials, or equipment complete and ready for intended use.

- F. Unless stated otherwise in the Contract Documents, words or phrases that have a well-known technical or construction industry or trade meaning are used in the Contract Documents in accordance with such recognized meaning.

ARTICLE 2 – PRELIMINARY MATTERS

2.01 *Delivery of Bonds and Evidence of Insurance*

- A. *Bonds:* When Contractor delivers the executed counterparts of the Agreement to Owner, Contractor shall also deliver to Owner such bonds as Contractor may be required to furnish.
- B. *Evidence of Contractor’s Insurance:* When Contractor delivers the executed counterparts of the Agreement to Owner, Contractor shall also deliver to Owner, with copies to each named insured and additional insured (as identified in the Supplementary Conditions or elsewhere in the Contract),

the certificates and other evidence of insurance required to be provided by Contractor in accordance with Article 6.

- C. *Evidence of Owner's Insurance:* After receipt of the executed counterparts of the Agreement and all required bonds and insurance documentation, Owner shall promptly deliver to Contractor, with copies to each named insured and additional insured (as identified in the Supplementary Conditions or otherwise), the certificates and other evidence of insurance required to be provided by Owner under Article 6.

2.02 *Copies of Documents*

- A. Owner shall furnish to Contractor four printed copies of the Contract (including one fully executed counterpart of the Agreement), and one copy in electronic portable document format (PDF). Additional printed copies will be furnished upon request at the cost of reproduction.
- B. Owner shall maintain and safeguard at least one original printed record version of the Contract, including Drawings and Specifications signed and sealed by Engineer and other design professionals. Owner shall make such original printed record version of the Contract available to Contractor for review. Owner may delegate the responsibilities under this provision to Engineer.

2.03 *Before Starting Construction*

- A. *Preliminary Schedules:* Within 10 days after the Effective Date of the Contract (or as otherwise specifically required by the Contract Documents), Contractor shall submit to Engineer for timely review:
 - 1. a preliminary Progress Schedule indicating the times (numbers of days or dates) for starting and completing the various stages of the Work, including any Milestones specified in the Contract;
 - 2. a preliminary Schedule of Submittals; and
 - 3. a preliminary Schedule of Values for all of the Work which includes quantities and prices of items which when added together equal the Contract Price and subdivides the Work into component parts in sufficient detail to serve as the basis for progress payments during performance of the Work. Such prices will include an appropriate amount of overhead and profit applicable to each item of Work.

2.04 *Preconstruction Conference; Designation of Authorized Representatives*

- A. Before any Work at the Site is started, a conference attended by Owner, Contractor, Engineer, and others as appropriate will be held to establish a working understanding among the parties as to the Work and to discuss the schedules referred to in Paragraph 2.03.A, procedures for handling Shop Drawings, Samples, and other submittals, processing Applications for Payment, electronic or digital transmittals, and maintaining required records.
- B. At this conference Owner and Contractor each shall designate, in writing, a specific individual to act as its authorized representative with respect to the services and responsibilities under the Contract. Such individuals shall have the authority to transmit and receive information, render decisions relative to the Contract, and otherwise act on behalf of each respective party.

2.05 *Initial Acceptance of Schedules*

- A. At least 10 days before submission of the first Application for Payment a conference, attended by Contractor, Engineer, and others as appropriate, will be held to review for acceptability to Engineer as provided below the schedules submitted in accordance with Paragraph 2.03.A. Contractor shall have an additional 10 days to make corrections and adjustments and to complete and resubmit the

schedules. No progress payment shall be made to Contractor until acceptable schedules are submitted to Engineer.

1. The Progress Schedule will be acceptable to Engineer if it provides an orderly progression of the Work to completion within the Contract Times. Such acceptance will not impose on Engineer responsibility for the Progress Schedule, for sequencing, scheduling, or progress of the Work, nor interfere with or relieve Contractor from Contractor's full responsibility therefor.
2. Contractor's Schedule of Submittals will be acceptable to Engineer if it provides a workable arrangement for reviewing and processing the required submittals.
3. Contractor's Schedule of Values will be acceptable to Engineer as to form and substance if it provides a reasonable allocation of the Contract Price to the component parts of the Work.

2.06 *Electronic Transmittals*

- A. Except as otherwise stated elsewhere in the Contract, the Owner, Engineer, and Contractor may transmit, and shall accept, Project-related correspondence, text, data, documents, drawings, information, and graphics, including but not limited to Shop Drawings and other submittals, in electronic media or digital format, either directly, or through access to a secure Project website.
- B. If the Contract does not establish protocols for electronic or digital transmittals, then Owner, Engineer, and Contractor shall jointly develop such protocols.
- C. When transmitting items in electronic media or digital format, the transmitting party makes no representations as to long term compatibility, usability, or readability of the items resulting from the recipient's use of software application packages, operating systems, or computer hardware differing from those used in the drafting or transmittal of the items, or from those established in applicable transmittal protocols.

ARTICLE 3 – DOCUMENTS: INTENT, REQUIREMENTS, REUSE

3.01 *Intent*

- A. The Contract Documents are complementary; what is required by one is as binding as if required by all.
- B. It is the intent of the Contract Documents to describe a functionally complete project (or part thereof) to be constructed in accordance with the Contract Documents.
- C. Unless otherwise stated in the Contract Documents, if there is a discrepancy between the electronic or digital versions of the Contract Documents (including any printed copies derived from such electronic or digital versions) and the printed record version, the printed record version shall govern.
- D. The Contract supersedes prior negotiations, representations, and agreements, whether written or oral.
- E. Engineer will issue clarifications and interpretations of the Contract Documents as provided herein.

3.02 *Reference Standards*

- A. Standards Specifications, Codes, Laws and Regulations
 1. Reference in the Contract Documents to standard specifications, manuals, reference standards, or codes of any technical society, organization, or association, or to Laws or Regulations, whether such reference be specific or by implication, shall mean the standard specification, manual, reference standard, code, or Laws or Regulations in effect at the time of

opening of Bids (or on the Effective Date of the Contract if there were no Bids), except as may be otherwise specifically stated in the Contract Documents.

2. No provision of any such standard specification, manual, reference standard, or code, or any instruction of a Supplier, shall be effective to change the duties or responsibilities of Owner, Contractor, or Engineer, or any of their subcontractors, consultants, agents, or employees, from those set forth in the part of the Contract Documents prepared by or for Engineer. No such provision or instruction shall be effective to assign to Owner, Engineer, or any of their officers, directors, members, partners, employees, agents, consultants, or subcontractors, any duty or authority to supervise or direct the performance of the Work or any duty or authority to undertake responsibility inconsistent with the provisions of the part of the Contract Documents prepared by or for Engineer.

3.03 *Reporting and Resolving Discrepancies*

A. *Reporting Discrepancies:*

1. *Contractor's Verification of Figures and Field Measurements:* Before undertaking each part of the Work, Contractor shall carefully study the Contract Documents, and check and verify pertinent figures and dimensions therein, particularly with respect to applicable field measurements. Contractor shall promptly report in writing to Engineer any conflict, error, ambiguity, or discrepancy that Contractor discovers, or has actual knowledge of, and shall not proceed with any Work affected thereby until the conflict, error, ambiguity, or discrepancy is resolved, by a clarification or interpretation by Engineer, or by an amendment or supplement to the Contract Documents issued pursuant to Paragraph 11.01.
2. *Contractor's Review of Contract Documents:* If, before or during the performance of the Work, Contractor discovers any conflict, error, ambiguity, or discrepancy within the Contract Documents, or between the Contract Documents and (a) any applicable Law or Regulation, (b) actual field conditions, (c) any standard specification, manual, reference standard, or code, or (d) any instruction of any Supplier, then Contractor shall promptly report it to Engineer in writing. Contractor shall not proceed with the Work affected thereby (except in an emergency as required by Paragraph 7.15) until the conflict, error, ambiguity, or discrepancy is resolved, by a clarification or interpretation by Engineer, or by an amendment or supplement to the Contract Documents issued pursuant to Paragraph 11.01.
3. Contractor shall not be liable to Owner or Engineer for failure to report any conflict, error, ambiguity, or discrepancy in the Contract Documents unless Contractor had actual knowledge thereof.

B. *Resolving Discrepancies:*

1. Except as may be otherwise specifically stated in the Contract Documents, the provisions of the part of the Contract Documents prepared by or for Engineer shall take precedence in resolving any conflict, error, ambiguity, or discrepancy between such provisions of the Contract Documents and:
 - a. the provisions of any standard specification, manual, reference standard, or code, or the instruction of any Supplier (whether or not specifically incorporated by reference as a Contract Document); or
 - b. the provisions of any Laws or Regulations applicable to the performance of the Work (unless such an interpretation of the provisions of the Contract Documents would result in violation of such Law or Regulation).

3.04 *Requirements of the Contract Documents*

- A. During the performance of the Work and until final payment, Contractor and Owner shall submit to the Engineer all matters in question concerning the requirements of the Contract Documents (sometimes referred to as requests for information or interpretation—RFIs), or relating to the acceptability of the Work under the Contract Documents, as soon as possible after such matters arise. Engineer will be the initial interpreter of the requirements of the Contract Documents, and judge of the acceptability of the Work thereunder.
- B. Engineer will, with reasonable promptness, render a written clarification, interpretation, or decision on the issue submitted, or initiate an amendment or supplement to the Contract Documents. Engineer's written clarification, interpretation, or decision will be final and binding on Contractor, unless it appeals by submitting a Change Proposal, and on Owner, unless it appeals by filing a Claim.
- C. If a submitted matter in question concerns terms and conditions of the Contract Documents that do not involve (1) the performance or acceptability of the Work under the Contract Documents, (2) the design (as set forth in the Drawings, Specifications, or otherwise), or (3) other engineering or technical matters, then Engineer will promptly give written notice to Owner and Contractor that Engineer is unable to provide a decision or interpretation. If Owner and Contractor are unable to agree on resolution of such a matter in question, either party may pursue resolution as provided in Article 12.

3.05 *Reuse of Documents*

- A. Contractor and its Subcontractors and Suppliers shall not:
 - 1. have or acquire any title to or ownership rights in any of the Drawings, Specifications, or other documents (or copies of any thereof) prepared by or bearing the seal of Engineer or its consultants, including electronic media editions, or reuse any such Drawings, Specifications, other documents, or copies thereof on extensions of the Project or any other project without written consent of Owner and Engineer and specific written verification or adaptation by Engineer; or
 - 2. have or acquire any title or ownership rights in any other Contract Documents, reuse any such Contract Documents for any purpose without Owner's express written consent, or violate any copyrights pertaining to such Contract Documents.
- B. The prohibitions of this Paragraph 3.05 will survive final payment, or termination of the Contract. Nothing herein shall preclude Contractor from retaining copies of the Contract Documents for record purposes.

ARTICLE 4 – COMMENCEMENT AND PROGRESS OF THE WORK

4.01 *Commencement of Contract Times; Notice to Proceed*

- A. The Contract Times will commence to run on the thirtieth day after the Effective Date of the Contract or, if a Notice to Proceed is given, on the day indicated in the Notice to Proceed. A Notice to Proceed may be given at any time within 30 days after the Effective Date of the Contract. In no event will the Contract Times commence to run later than the sixtieth day after the day of Bid opening or the thirtieth day after the Effective Date of the Contract, whichever date is earlier.

4.02 *Starting the Work*

- A. Contractor shall start to perform the Work on the date when the Contract Times commence to run. No Work shall be done at the Site prior to such date.

4.03 *Reference Points*

- A. Owner shall provide engineering surveys to establish reference points for construction which in Engineer's judgment are necessary to enable Contractor to proceed with the Work. Contractor shall be responsible for laying out the Work, shall protect and preserve the established reference points and property monuments, and shall make no changes or relocations without the prior written approval of Owner. Contractor shall report to Engineer whenever any reference point or property monument is lost or destroyed or requires relocation because of necessary changes in grades or locations, and shall be responsible for the accurate replacement or relocation of such reference points or property monuments by professionally qualified personnel.

4.04 *Progress Schedule*

- A. Contractor shall adhere to the Progress Schedule established in accordance with Paragraph 2.05 as it may be adjusted from time to time as provided below.
 - 1. Contractor shall submit to Engineer for acceptance (to the extent indicated in Paragraph 2.05) proposed adjustments in the Progress Schedule that will not result in changing the Contract Times.
 - 2. Proposed adjustments in the Progress Schedule that will change the Contract Times shall be submitted in accordance with the requirements of Article 11.
- B. Contractor shall carry on the Work and adhere to the Progress Schedule during all disputes or disagreements with Owner. No Work shall be delayed or postponed pending resolution of any disputes or disagreements, or during any appeal process, except as permitted by Paragraph 16.04, or as Owner and Contractor may otherwise agree in writing.

4.05 *Delays in Contractor's Progress*

- A. If Owner, Engineer, or anyone for whom Owner is responsible, delays, disrupts, or interferes with the performance or progress of the Work, then Contractor shall be entitled to an equitable adjustment in the Contract Times and Contract Price. Contractor's entitlement to an adjustment of the Contract Times is conditioned on such adjustment being essential to Contractor's ability to complete the Work within the Contract Times.
- B. Contractor shall not be entitled to an adjustment in Contract Price or Contract Times for delay, disruption, or interference caused by or within the control of Contractor. Delay, disruption, and interference attributable to and within the control of a Subcontractor or Supplier shall be deemed to be within the control of Contractor.
- C. If Contractor's performance or progress is delayed, disrupted, or interfered with by unanticipated causes not the fault of and beyond the control of Owner, Contractor, and those for which they are responsible, then Contractor shall be entitled to an equitable adjustment in Contract Times. Contractor's entitlement to an adjustment of the Contract Times is conditioned on such adjustment being essential to Contractor's ability to complete the Work within the Contract Times. Such an adjustment shall be Contractor's sole and exclusive remedy for the delays, disruption, and interference described in this paragraph. Causes of delay, disruption, or interference that may give rise to an adjustment in Contract Times under this paragraph include but are not limited to the following:
 - 1. severe and unavoidable natural catastrophes such as fires, floods, epidemics, and earthquakes;
 - 2. abnormal weather conditions;
 - 3. acts or failures to act of utility owners (other than those performing other work at or adjacent to the Site by arrangement with the Owner, as contemplated in Article 8); and

4. acts of war or terrorism.
- D. Delays, disruption, and interference to the performance or progress of the Work resulting from the existence of a differing subsurface or physical condition, an Underground Facility that was not shown or indicated by the Contract Documents, or not shown or indicated with reasonable accuracy, and those resulting from Hazardous Environmental Conditions, are governed by Article 5.
- E. Paragraph 8.03 governs delays, disruption, and interference to the performance or progress of the Work resulting from the performance of certain other work at or adjacent to the Site.
- F. Contractor shall not be entitled to an adjustment in Contract Price or Contract Times for any delay, disruption, or interference if such delay is concurrent with a delay, disruption, or interference caused by or within the control of Contractor.
- G. Contractor must submit any Change Proposal seeking an adjustment in Contract Price or Contract Times under this paragraph within 30 days of the commencement of the delaying, disrupting, or interfering event.

ARTICLE 5 – AVAILABILITY OF LANDS; SUBSURFACE AND PHYSICAL CONDITIONS; HAZARDOUS ENVIRONMENTAL CONDITIONS

5.01 *Availability of Lands*

- A. Owner shall furnish the Site. Owner shall notify Contractor of any encumbrances or restrictions not of general application but specifically related to use of the Site with which Contractor must comply in performing the Work.
- B. Upon reasonable written request, Owner shall furnish Contractor with a current statement of record legal title and legal description of the lands upon which permanent improvements are to be made and Owner's interest therein as necessary for giving notice of or filing a mechanic's or construction lien against such lands in accordance with applicable Laws and Regulations.
- C. Contractor shall provide for all additional lands and access thereto that may be required for temporary construction facilities or storage of materials and equipment.

5.02 *Use of Site and Other Areas*

- A. *Limitation on Use of Site and Other Areas:*
 1. Contractor shall confine construction equipment, temporary construction facilities, the storage of materials and equipment, and the operations of workers to the Site, adjacent areas that Contractor has arranged to use through construction easements or otherwise, and other adjacent areas permitted by Laws and Regulations, and shall not unreasonably encumber the Site and such other adjacent areas with construction equipment or other materials or equipment. Contractor shall assume full responsibility for (a) damage to the Site; (b) damage to any such other adjacent areas used for Contractor's operations; (c) damage to any other adjacent land or areas; and (d) for injuries and losses sustained by the owners or occupants of any such land or areas; provided that such damage or injuries result from the performance of the Work or from other actions or conduct of the Contractor or those for which Contractor is responsible.
 2. If a damage or injury claim is made by the owner or occupant of any such land or area because of the performance of the Work, or because of other actions or conduct of the Contractor or those for which Contractor is responsible, Contractor shall (a) take immediate corrective or remedial action as required by Paragraph 7.12, or otherwise; (b) promptly attempt to settle the claim as to all parties through negotiations with such owner or occupant, or otherwise resolve the claim by arbitration or other dispute resolution proceeding, or at law; and (c) to

the fullest extent permitted by Laws and Regulations, indemnify and hold harmless Owner and Engineer, and the officers, directors, members, partners, employees, agents, consultants and subcontractors of each and any of them from and against any such claim, and against all costs, losses, and damages (including but not limited to all fees and charges of engineers, architects, attorneys, and other professionals and all court or arbitration or other dispute resolution costs) arising out of or relating to any claim or action, legal or equitable, brought by any such owner or occupant against Owner, Engineer, or any other party indemnified hereunder to the extent caused directly or indirectly, in whole or in part by, or based upon, Contractor's performance of the Work, or because of other actions or conduct of the Contractor or those for which Contractor is responsible.

- B. *Removal of Debris During Performance of the Work:* During the progress of the Work the Contractor shall keep the Site and other adjacent areas free from accumulations of waste materials, rubbish, and other debris. Removal and disposal of such waste materials, rubbish, and other debris shall conform to applicable Laws and Regulations.
- C. *Cleaning:* Prior to Substantial Completion of the Work Contractor shall clean the Site and the Work and make it ready for utilization by Owner. At the completion of the Work Contractor shall remove from the Site and adjacent areas all tools, appliances, construction equipment and machinery, and surplus materials and shall restore to original condition all property not designated for alteration by the Contract Documents.
- D. *Loading of Structures:* Contractor shall not load nor permit any part of any structure to be loaded in any manner that will endanger the structure, nor shall Contractor subject any part of the Work or adjacent structures or land to stresses or pressures that will endanger them.

5.03 *Subsurface and Physical Conditions*

- A. *Reports and Drawings:* The Supplementary Conditions identify:
 - 1. those reports known to Owner of explorations and tests of subsurface conditions at or adjacent to the Site;
 - 2. those drawings known to Owner of physical conditions relating to existing surface or subsurface structures at the Site (except Underground Facilities); and
 - 3. Technical Data contained in such reports and drawings.
- B. *Reliance by Contractor on Technical Data Authorized:* Contractor may rely upon the accuracy of the Technical Data expressly identified in the Supplementary Conditions with respect to such reports and drawings, but such reports and drawings are not Contract Documents. If no such express identification has been made, then Contractor may rely upon the accuracy of the Technical Data (as defined in Article 1) contained in any geotechnical or environmental report prepared for the Project and made available to Contractor. Except for such reliance on Technical Data, Contractor may not rely upon or make any claim against Owner or Engineer, or any of their officers, directors, members, partners, employees, agents, consultants, or subcontractors, with respect to:
 - 1. the completeness of such reports and drawings for Contractor's purposes, including, but not limited to, any aspects of the means, methods, techniques, sequences, and procedures of construction to be employed by Contractor, and safety precautions and programs incident thereto; or
 - 2. other data, interpretations, opinions, and information contained in such reports or shown or indicated in such drawings; or
 - 3. any Contractor interpretation of or conclusion drawn from any Technical Data or any such other data, interpretations, opinions, or information.

5.04 *Differing Subsurface or Physical Conditions*

- A. *Notice by Contractor:* If Contractor believes that any subsurface or physical condition that is uncovered or revealed at the Site either:
1. is of such a nature as to establish that any Technical Data on which Contractor is entitled to rely as provided in Paragraph 5.03 is materially inaccurate; or
 2. is of such a nature as to require a change in the Drawings or Specifications; or
 3. differs materially from that shown or indicated in the Contract Documents; or
 4. is of an unusual nature, and differs materially from conditions ordinarily encountered and generally recognized as inherent in work of the character provided for in the Contract Documents;

then Contractor shall, promptly after becoming aware thereof and before further disturbing the subsurface or physical conditions or performing any Work in connection therewith (except in an emergency as required by Paragraph 7.15), notify Owner and Engineer in writing about such condition. Contractor shall not further disturb such condition or perform any Work in connection therewith (except with respect to an emergency) until receipt of a written statement permitting Contractor to do so.

- B. *Engineer's Review:* After receipt of written notice as required by the preceding paragraph, Engineer will promptly review the subsurface or physical condition in question; determine the necessity of Owner's obtaining additional exploration or tests with respect to the condition; conclude whether the condition falls within any one or more of the differing site condition categories in Paragraph 5.04.A above; obtain any pertinent cost or schedule information from Contractor; prepare recommendations to Owner regarding the Contractor's resumption of Work in connection with the subsurface or physical condition in question and the need for any change in the Drawings or Specifications; and advise Owner in writing of Engineer's findings, conclusions, and recommendations.
- C. *Owner's Statement to Contractor Regarding Site Condition:* After receipt of Engineer's written findings, conclusions, and recommendations, Owner shall issue a written statement to Contractor (with a copy to Engineer) regarding the subsurface or physical condition in question, addressing the resumption of Work in connection with such condition, indicating whether any change in the Drawings or Specifications will be made, and adopting or rejecting Engineer's written findings, conclusions, and recommendations, in whole or in part.
- D. *Possible Price and Times Adjustments:*
1. Contractor shall be entitled to an equitable adjustment in Contract Price or Contract Times, or both, to the extent that the existence of a differing subsurface or physical condition, or any related delay, disruption, or interference, causes an increase or decrease in Contractor's cost of, or time required for, performance of the Work; subject, however, to the following:
 - a. such condition must fall within any one or more of the categories described in Paragraph 5.04.A;
 - b. with respect to Work that is paid for on a unit price basis, any adjustment in Contract Price will be subject to the provisions of Paragraph 13.03; and,
 - c. Contractor's entitlement to an adjustment of the Contract Times is conditioned on such adjustment being essential to Contractor's ability to complete the Work within the Contract Times.

2. Contractor shall not be entitled to any adjustment in the Contract Price or Contract Times with respect to a subsurface or physical condition if:
 - a. Contractor knew of the existence of such condition at the time Contractor made a commitment to Owner with respect to Contract Price and Contract Times by the submission of a Bid or becoming bound under a negotiated contract, or otherwise; or
 - b. the existence of such condition reasonably could have been discovered or revealed as a result of any examination, investigation, exploration, test, or study of the Site and contiguous areas expressly required by the Bidding Requirements or Contract Documents to be conducted by or for Contractor prior to Contractor's making such commitment; or
 - c. Contractor failed to give the written notice as required by Paragraph 5.04.A.
3. If Owner and Contractor agree regarding Contractor's entitlement to and the amount or extent of any adjustment in the Contract Price or Contract Times, or both, then any such adjustment shall be set forth in a Change Order.
4. Contractor may submit a Change Proposal regarding its entitlement to or the amount or extent of any adjustment in the Contract Price or Contract Times, or both, no later than 30 days after Owner's issuance of the Owner's written statement to Contractor regarding the subsurface or physical condition in question.

5.05 *Underground Facilities*

- A. *Contractor's Responsibilities:* The information and data shown or indicated in the Contract Documents with respect to existing Underground Facilities at or adjacent to the Site is based on information and data furnished to Owner or Engineer by the owners of such Underground Facilities, including Owner, or by others. Unless it is otherwise expressly provided in the Supplementary Conditions:
 1. Owner and Engineer do not warrant or guarantee the accuracy or completeness of any such information or data provided by others; and
 2. the cost of all of the following will be included in the Contract Price, and Contractor shall have full responsibility for:
 - a. reviewing and checking all information and data regarding existing Underground Facilities at the Site;
 - b. locating all Underground Facilities shown or indicated in the Contract Documents as being at the Site;
 - c. coordination of the Work with the owners (including Owner) of such Underground Facilities, during construction; and
 - d. the safety and protection of all existing Underground Facilities at the Site, and repairing any damage thereto resulting from the Work.
- B. *Notice by Contractor:* If Contractor believes that an Underground Facility that is uncovered or revealed at the Site was not shown or indicated in the Contract Documents, or was not shown or indicated with reasonable accuracy, then Contractor shall, promptly after becoming aware thereof and before further disturbing conditions affected thereby or performing any Work in connection therewith (except in an emergency as required by Paragraph 7.15), identify the owner of such Underground Facility and give written notice to that owner and to Owner and Engineer.
- C. *Engineer's Review:* Engineer will promptly review the Underground Facility and conclude whether such Underground Facility was not shown or indicated in the Contract Documents, or was not shown or indicated with reasonable accuracy; obtain any pertinent cost or schedule information

from Contractor; prepare recommendations to Owner regarding the Contractor's resumption of Work in connection with the Underground Facility in question; determine the extent, if any, to which a change is required in the Drawings or Specifications to reflect and document the consequences of the existence or location of the Underground Facility; and advise Owner in writing of Engineer's findings, conclusions, and recommendations. During such time, Contractor shall be responsible for the safety and protection of such Underground Facility.

D. *Owner's Statement to Contractor Regarding Underground Facility:* After receipt of Engineer's written findings, conclusions, and recommendations, Owner shall issue a written statement to Contractor (with a copy to Engineer) regarding the Underground Facility in question, addressing the resumption of Work in connection with such Underground Facility, indicating whether any change in the Drawings or Specifications will be made, and adopting or rejecting Engineer's written findings, conclusions, and recommendations in whole or in part.

E. *Possible Price and Times Adjustments:*

1. Contractor shall be entitled to an equitable adjustment in the Contract Price or Contract Times, or both, to the extent that any existing Underground Facility at the Site that was not shown or indicated in the Contract Documents, or was not shown or indicated with reasonable accuracy, or any related delay, disruption, or interference, causes an increase or decrease in Contractor's cost of, or time required for, performance of the Work; subject, however, to the following:

- a. Contractor did not know of and could not reasonably have been expected to be aware of or to have anticipated the existence or actual location of the Underground Facility in question;
- b. With respect to Work that is paid for on a unit price basis, any adjustment in Contract Price will be subject to the provisions of Paragraph 13.03;
- c. Contractor's entitlement to an adjustment of the Contract Times is conditioned on such adjustment being essential to Contractor's ability to complete the Work within the Contract Times; and
- d. Contractor gave the notice required in Paragraph 5.05.B.

2. If Owner and Contractor agree regarding Contractor's entitlement to and the amount or extent of any adjustment in the Contract Price or Contract Times, or both, then any such adjustment shall be set forth in a Change Order.

3. Contractor may submit a Change Proposal regarding its entitlement to or the amount or extent of any adjustment in the Contract Price or Contract Times, or both, no later than 30 days after Owner's issuance of the Owner's written statement to Contractor regarding the Underground Facility in question.

5.06 *Hazardous Environmental Conditions at Site*

A. *Reports and Drawings:* The Supplementary Conditions identify:

1. those reports and drawings known to Owner relating to Hazardous Environmental Conditions that have been identified at or adjacent to the Site; and
2. Technical Data contained in such reports and drawings.

B. *Reliance by Contractor on Technical Data Authorized:* Contractor may rely upon the accuracy of the Technical Data expressly identified in the Supplementary Conditions with respect to such reports and drawings, but such reports and drawings are not Contract Documents. If no such express identification has been made, then Contractor may rely on the accuracy of the Technical Data (as

defined in Article 1) contained in any geotechnical or environmental report prepared for the Project and made available to Contractor. Except for such reliance on Technical Data, Contractor may not rely upon or make any claim against Owner or Engineer, or any of their officers, directors, members, partners, employees, agents, consultants, or subcontractors with respect to:

1. the completeness of such reports and drawings for Contractor's purposes, including, but not limited to, any aspects of the means, methods, techniques, sequences and procedures of construction to be employed by Contractor and safety precautions and programs incident thereto; or
 2. other data, interpretations, opinions and information contained in such reports or shown or indicated in such drawings; or
 3. any Contractor interpretation of or conclusion drawn from any Technical Data or any such other data, interpretations, opinions or information.
- C. Contractor shall not be responsible for removing or remediating any Hazardous Environmental Condition encountered, uncovered, or revealed at the Site unless such removal or remediation is expressly identified in the Contract Documents to be within the scope of the Work.
- D. Contractor shall be responsible for controlling, containing, and duly removing all Constituents of Concern brought to the Site by Contractor, Subcontractors, Suppliers, or anyone else for whom Contractor is responsible, and for any associated costs; and for the costs of removing and remediating any Hazardous Environmental Condition created by the presence of any such Constituents of Concern.
- E. If Contractor encounters, uncovers, or reveals a Hazardous Environmental Condition whose removal or remediation is not expressly identified in the Contract Documents as being within the scope of the Work, or if Contractor or anyone for whom Contractor is responsible creates a Hazardous Environmental Condition, then Contractor shall immediately: (1) secure or otherwise isolate such condition; (2) stop all Work in connection with such condition and in any area affected thereby (except in an emergency as required by Paragraph 7.15); and (3) notify Owner and Engineer (and promptly thereafter confirm such notice in writing). Owner shall promptly consult with Engineer concerning the necessity for Owner to retain a qualified expert to evaluate such condition or take corrective action, if any. Promptly after consulting with Engineer, Owner shall take such actions as are necessary to permit Owner to timely obtain required permits and provide Contractor the written notice required by Paragraph 5.06.F. If Contractor or anyone for whom Contractor is responsible created the Hazardous Environmental Condition in question, then Owner may remove and remediate the Hazardous Environmental Condition, and impose a set-off against payments to account for the associated costs.
- F. Contractor shall not resume Work in connection with such Hazardous Environmental Condition or in any affected area until after Owner has obtained any required permits related thereto, and delivered written notice to Contractor either (1) specifying that such condition and any affected area is or has been rendered safe for the resumption of Work, or (2) specifying any special conditions under which such Work may be resumed safely.
- G. If Owner and Contractor cannot agree as to entitlement to or on the amount or extent, if any, of any adjustment in Contract Price or Contract Times, or both, as a result of such Work stoppage or such special conditions under which Work is agreed to be resumed by Contractor, then within 30 days of Owner's written notice regarding the resumption of Work, Contractor may submit a Change Proposal, or Owner may impose a set-off.
- H. If after receipt of such written notice Contractor does not agree to resume such Work based on a reasonable belief it is unsafe, or does not agree to resume such Work under such special conditions, then Owner may order the portion of the Work that is in the area affected by such

condition to be deleted from the Work, following the contractual change procedures in Article 11. Owner may have such deleted portion of the Work performed by Owner's own forces or others in accordance with Article 8.

- I. To the fullest extent permitted by Laws and Regulations, Owner shall indemnify and hold harmless Contractor, Subcontractors, and Engineer, and the officers, directors, members, partners, employees, agents, consultants, and subcontractors of each and any of them from and against all claims, costs, losses, and damages (including but not limited to all fees and charges of engineers, architects, attorneys, and other professionals and all court or arbitration or other dispute resolution costs) arising out of or relating to a Hazardous Environmental Condition, provided that such Hazardous Environmental Condition (1) was not shown or indicated in the Drawings, Specifications, or other Contract Documents, identified as Technical Data entitled to limited reliance pursuant to Paragraph 5.06.B, or identified in the Contract Documents to be included within the scope of the Work, and (2) was not created by Contractor or by anyone for whom Contractor is responsible. Nothing in this Paragraph 5.06.I shall obligate Owner to indemnify any individual or entity from and against the consequences of that individual's or entity's own negligence.
- J. To the fullest extent permitted by Laws and Regulations, Contractor shall indemnify and hold harmless Owner and Engineer, and the officers, directors, members, partners, employees, agents, consultants, and subcontractors of each and any of them from and against all claims, costs, losses, and damages (including but not limited to all fees and charges of engineers, architects, attorneys, and other professionals and all court or arbitration or other dispute resolution costs) arising out of or relating to the failure to control, contain, or remove a Constituent of Concern brought to the Site by Contractor or by anyone for whom Contractor is responsible, or to a Hazardous Environmental Condition created by Contractor or by anyone for whom Contractor is responsible. Nothing in this Paragraph 5.06.J shall obligate Contractor to indemnify any individual or entity from and against the consequences of that individual's or entity's own negligence.
- K. The provisions of Paragraphs 5.03, 5.04, and 5.05 do not apply to the presence of Constituents of Concern or to a Hazardous Environmental Condition uncovered or revealed at the Site.

ARTICLE 6 – BONDS AND INSURANCE

6.01 *Performance, Payment, and Other Bonds*

- A. Contractor shall furnish a performance bond and a payment bond, each in an amount at least equal to the Contract Price, as security for the faithful performance and payment of all of Contractor's obligations under the Contract. These bonds shall remain in effect until one year after the date when final payment becomes due or until completion of the correction period specified in Paragraph 15.08, whichever is later, except as provided otherwise by Laws or Regulations, the Supplementary Conditions, or other specific provisions of the Contract. Contractor shall also furnish such other bonds as are required by the Supplementary Conditions or other specific provisions of the Contract.
- B. All bonds shall be in the form prescribed by the Contract except as provided otherwise by Laws or Regulations, and shall be executed by such sureties as are named in "Companies Holding Certificates of Authority as Acceptable Sureties on Federal Bonds and as Acceptable Reinsuring Companies" as published in Circular 570 (as amended and supplemented) by the Financial Management Service, Surety Bond Branch, U.S. Department of the Treasury. A bond signed by an agent or attorney-in-fact must be accompanied by a certified copy of that individual's authority to bind the surety. The evidence of authority shall show that it is effective on the date the agent or attorney-in-fact signed the accompanying bond.

- C. Contractor shall obtain the required bonds from surety companies that are duly licensed or authorized in the jurisdiction in which the Project is located to issue bonds in the required amounts.
- D. If the surety on a bond furnished by Contractor is declared bankrupt or becomes insolvent, or its right to do business is terminated in any state or jurisdiction where any part of the Project is located, or the surety ceases to meet the requirements above, then Contractor shall promptly notify Owner and Engineer and shall, within 20 days after the event giving rise to such notification, provide another bond and surety, both of which shall comply with the bond and surety requirements above.
- E. If Contractor has failed to obtain a required bond, Owner may exclude the Contractor from the Site and exercise Owner's termination rights under Article 16.
- F. Upon request, Owner shall provide a copy of the payment bond to any Subcontractor, Supplier, or other person or entity claiming to have furnished labor or materials used in the performance of the Work.

6.02 *Insurance—General Provisions*

- A. Owner and Contractor shall obtain and maintain insurance as required in this Article and in the Supplementary Conditions.
- B. All insurance required by the Contract to be purchased and maintained by Owner or Contractor shall be obtained from insurance companies that are duly licensed or authorized, in the state or jurisdiction in which the Project is located, to issue insurance policies for the required limits and coverages. Unless a different standard is indicated in the Supplementary Conditions, all companies that provide insurance policies required under this Contract shall have an A.M. Best rating of A-VII or better.
- C. Contractor shall deliver to Owner, with copies to each named insured and additional insured (as identified in this Article, in the Supplementary Conditions, or elsewhere in the Contract), certificates of insurance establishing that Contractor has obtained and is maintaining the policies, coverages, and endorsements required by the Contract. Upon request by Owner or any other insured, Contractor shall also furnish other evidence of such required insurance, including but not limited to copies of policies and endorsements, and documentation of applicable self-insured retentions and deductibles. Contractor may block out (redact) any confidential premium or pricing information contained in any policy or endorsement furnished under this provision.
- D. Owner shall deliver to Contractor, with copies to each named insured and additional insured (as identified in this Article, the Supplementary Conditions, or elsewhere in the Contract), certificates of insurance establishing that Owner has obtained and is maintaining the policies, coverages, and endorsements required of Owner by the Contract (if any). Upon request by Contractor or any other insured, Owner shall also provide other evidence of such required insurance (if any), including but not limited to copies of policies and endorsements, and documentation of applicable self-insured retentions and deductibles. Owner may block out (redact) any confidential premium or pricing information contained in any policy or endorsement furnished under this provision.
- E. Failure of Owner or Contractor to demand such certificates or other evidence of the other party's full compliance with these insurance requirements, or failure of Owner or Contractor to identify a deficiency in compliance from the evidence provided, shall not be construed as a waiver of the other party's obligation to obtain and maintain such insurance.
- F. If either party does not purchase or maintain all of the insurance required of such party by the Contract, such party shall notify the other party in writing of such failure to purchase prior to the start of the Work, or of such failure to maintain prior to any change in the required coverage.

- G. If Contractor has failed to obtain and maintain required insurance, Owner may exclude the Contractor from the Site, impose an appropriate set-off against payment, and exercise Owner's termination rights under Article 16.
- H. Without prejudice to any other right or remedy, if a party has failed to obtain required insurance, the other party may elect to obtain equivalent insurance to protect such other party's interests at the expense of the party who was required to provide such coverage, and the Contract Price shall be adjusted accordingly.
- I. Owner does not represent that insurance coverage and limits established in this Contract necessarily will be adequate to protect Contractor or Contractor's interests.
- J. The insurance and insurance limits required herein shall not be deemed as a limitation on Contractor's liability under the indemnities granted to Owner and other individuals and entities in the Contract.

6.03 *Contractor's Insurance*

- A. *Workers' Compensation*: Contractor shall purchase and maintain workers' compensation and employer's liability insurance for:
 - 1. claims under workers' compensation, disability benefits, and other similar employee benefit acts.
 - 2. United States Longshoreman and Harbor Workers' Compensation Act and Jones Act coverage (if applicable).
 - 3. claims for damages because of bodily injury, occupational sickness or disease, or death of Contractor's employees (by stop-gap endorsement in monopolist worker's compensation states).
 - 4. Foreign voluntary worker compensation (if applicable).
- B. *Commercial General Liability—Claims Covered*: Contractor shall purchase and maintain commercial general liability insurance, covering all operations by or on behalf of Contractor, on an occurrence basis, against:
 - 1. claims for damages because of bodily injury, sickness or disease, or death of any person other than Contractor's employees.
 - 2. claims for damages insured by reasonably available personal injury liability coverage.
 - 3. claims for damages, other than to the Work itself, because of injury to or destruction of tangible property wherever located, including loss of use resulting therefrom.
- C. *Commercial General Liability—Form and Content*: Contractor's commercial liability policy shall be written on a 1996 (or later) ISO commercial general liability form (occurrence form) and include the following coverages and endorsements:
 - 1. Products and completed operations coverage:
 - a. Such insurance shall be maintained for three years after final payment.
 - b. Contractor shall furnish Owner and each other additional insured (as identified in the Supplementary Conditions or elsewhere in the Contract) evidence of continuation of such insurance at final payment and three years thereafter.
 - 2. Blanket contractual liability coverage, to the extent permitted by law, including but not limited to coverage of Contractor's contractual indemnity obligations in Paragraph 7.18.
 - 3. Broad form property damage coverage.

4. Severability of interest.
 5. Underground, explosion, and collapse coverage.
 6. Personal injury coverage.
 7. Additional insured endorsements that include both ongoing operations and products and completed operations coverage through ISO Endorsements CG 20 10 10 01 and CG 20 37 10 01 (together); or CG 20 10 07 04 and CG 20 37 07 04 (together); or their equivalent.
 8. For design professional additional insureds, ISO Endorsement CG 20 32 07 04, "Additional Insured—Engineers, Architects or Surveyors Not Engaged by the Named Insured" or its equivalent.
- D. *Automobile liability*: Contractor shall purchase and maintain automobile liability insurance against claims for damages because of bodily injury or death of any person or property damage arising out of the ownership, maintenance, or use of any motor vehicle. The automobile liability policy shall be written on an occurrence basis.
 - E. *Umbrella or excess liability*: Contractor shall purchase and maintain umbrella or excess liability insurance written over the underlying employer's liability, commercial general liability, and automobile liability insurance described in the paragraphs above. Subject to industry-standard exclusions, the coverage afforded shall follow form as to each and every one of the underlying policies.
 - F. *Contractor's pollution liability insurance*: Contractor shall purchase and maintain a policy covering third-party injury and property damage claims, including clean-up costs, as a result of pollution conditions arising from Contractor's operations and completed operations. This insurance shall be maintained for no less than three years after final completion.
 - G. *Additional insureds*: The Contractor's commercial general liability, automobile liability, umbrella or excess, and pollution liability policies shall include and list as additional insureds Owner and Engineer, and any individuals or entities identified in the Supplementary Conditions; include coverage for the respective officers, directors, members, partners, employees, agents, consultants, and subcontractors of each and any of all such additional insureds; and the insurance afforded to these additional insureds shall provide primary coverage for all claims covered thereby (including as applicable those arising from both ongoing and completed operations) on a non-contributory basis. Contractor shall obtain all necessary endorsements to support these requirements.
 - H. *Contractor's professional liability insurance*: If Contractor will provide or furnish professional services under this Contract, through a delegation of professional design services or otherwise, then Contractor shall be responsible for purchasing and maintaining applicable professional liability insurance. This insurance shall provide protection against claims arising out of performance of professional design or related services, and caused by a negligent error, omission, or act for which the insured party is legally liable. It shall be maintained throughout the duration of the Contract and for a minimum of two years after Substantial Completion. If such professional design services are performed by a Subcontractor, and not by Contractor itself, then the requirements of this paragraph may be satisfied through the purchasing and maintenance of such insurance by such Subcontractor.
 - I. *General provisions*: The policies of insurance required by this Paragraph 6.03 shall:
 1. include at least the specific coverages provided in this Article.
 2. be written for not less than the limits of liability provided in this Article and in the Supplementary Conditions, or required by Laws or Regulations, whichever is greater.

3. contain a provision or endorsement that the coverage afforded will not be canceled, materially changed, or renewal refused until at least 10 days prior written notice has been given to Contractor. Within three days of receipt of any such written notice, Contractor shall provide a copy of the notice to Owner, Engineer, and each other insured under the policy.
 4. remain in effect at least until final payment (and longer if expressly required in this Article) and at all times thereafter when Contractor may be correcting, removing, or replacing defective Work as a warranty or correction obligation, or otherwise, or returning to the Site to conduct other tasks arising from the Contract Documents.
 5. be appropriate for the Work being performed and provide protection from claims that may arise out of or result from Contractor's performance of the Work and Contractor's other obligations under the Contract Documents, whether it is to be performed by Contractor, any Subcontractor or Supplier, or by anyone directly or indirectly employed by any of them to perform any of the Work, or by anyone for whose acts any of them may be liable.
- J. The coverage requirements for specific policies of insurance must be met by such policies, and not by reference to excess or umbrella insurance provided in other policies.

6.04 *Owner's Liability Insurance*

- A. In addition to the insurance required to be provided by Contractor under Paragraph 6.03, Owner, at Owner's option, may purchase and maintain at Owner's expense Owner's own liability insurance as will protect Owner against claims which may arise from operations under the Contract Documents.
- B. Owner's liability policies, if any, operate separately and independently from policies required to be provided by Contractor, and Contractor cannot rely upon Owner's liability policies for any of Contractor's obligations to the Owner, Engineer, or third parties.

6.05 *Property Insurance*

- A. *Builder's Risk:* Unless otherwise provided in the Supplementary Conditions, Contractor shall purchase and maintain builder's risk insurance upon the Work on a completed value basis, in the amount of the full insurable replacement cost thereof (subject to such deductible amounts as may be provided in the Supplementary Conditions or required by Laws and Regulations). This insurance shall:
 1. include the Owner and Contractor as named insureds, and all Subcontractors, and any individuals or entities required by the Supplementary Conditions to be insured under such builder's risk policy, as insureds or named insureds. For purposes of the remainder of this Paragraph 6.05, Paragraphs 6.06 and 6.07, and any corresponding Supplementary Conditions, the parties required to be insured shall collectively be referred to as "insureds."
 2. be written on a builder's risk "all risk" policy form that shall at least include insurance for physical loss or damage to the Work, temporary buildings, falsework, and materials and equipment in transit, and shall insure against at least the following perils or causes of loss: fire; lightning; windstorm; riot; civil commotion; terrorism; vehicle impact; aircraft; smoke; theft; vandalism and malicious mischief; mechanical breakdown, boiler explosion, and artificially generated electric current; earthquake; volcanic activity, and other earth movement; flood; collapse; explosion; debris removal; demolition occasioned by enforcement of Laws and Regulations; water damage (other than that caused by flood); and such other perils or causes of loss as may be specifically required by the Supplementary Conditions. If insurance against mechanical breakdown, boiler explosion, and artificially generated electric current; earthquake; volcanic activity, and other earth movement; or flood, are not commercially available under builder's risk policies, by endorsement or otherwise, such insurance may be provided through other insurance policies acceptable to Owner and Contractor.

3. cover, as insured property, at least the following: (a) the Work and all materials, supplies, machinery, apparatus, equipment, fixtures, and other property of a similar nature that are to be incorporated into or used in the preparation, fabrication, construction, erection, or completion of the Work, including Owner-furnished or assigned property; (b) spare parts inventory required within the scope of the Contract; and (c) temporary works which are not intended to form part of the permanent constructed Work but which are intended to provide working access to the Site, or to the Work under construction, or which are intended to provide temporary support for the Work under construction, including scaffolding, form work, fences, shoring, falsework, and temporary structures.
 4. cover expenses incurred in the repair or replacement of any insured property (including but not limited to fees and charges of engineers and architects).
 5. extend to cover damage or loss to insured property while in temporary storage at the Site or in a storage location outside the Site (but not including property stored at the premises of a manufacturer or Supplier).
 6. extend to cover damage or loss to insured property while in transit.
 7. allow for partial occupation or use of the Work by Owner, such that those portions of the Work that are not yet occupied or used by Owner shall remain covered by the builder's risk insurance.
 8. allow for the waiver of the insurer's subrogation rights, as set forth below.
 9. provide primary coverage for all losses and damages caused by the perils or causes of loss covered.
 10. not include a co-insurance clause.
 11. include an exception for ensuing losses from physical damage or loss with respect to any defective workmanship, design, or materials exclusions.
 12. include performance/hot testing and start-up.
 13. be maintained in effect, subject to the provisions herein regarding Substantial Completion and partial occupancy or use of the Work by Owner, until the Work is complete.
- B. *Notice of Cancellation or Change:* All the policies of insurance (and the certificates or other evidence thereof) required to be purchased and maintained in accordance with this Paragraph 6.05 will contain a provision or endorsement that the coverage afforded will not be canceled or materially changed or renewal refused until at least 10 days prior written notice has been given to the purchasing policyholder. Within three days of receipt of any such written notice, the purchasing policyholder shall provide a copy of the notice to each other insured.
- C. *Deductibles:* The purchaser of any required builder's risk or property insurance shall pay for costs not covered because of the application of a policy deductible.
- D. *Partial Occupancy or Use by Owner:* If Owner will occupy or use a portion or portions of the Work prior to Substantial Completion of all the Work as provided in Paragraph 15.04, then Owner (directly, if it is the purchaser of the builder's risk policy, or through Contractor) will provide notice of such occupancy or use to the builder's risk insurer. The builder's risk insurance shall not be canceled or permitted to lapse on account of any such partial use or occupancy; rather, those portions of the Work that are occupied or used by Owner may come off the builder's risk policy, while those portions of the Work not yet occupied or used by Owner shall remain covered by the builder's risk insurance.

- E. *Additional Insurance*: If Contractor elects to obtain other special insurance to be included in or supplement the builder's risk or property insurance policies provided under this Paragraph 6.05, it may do so at Contractor's expense.
- F. *Insurance of Other Property*: If the express insurance provisions of the Contract do not require or address the insurance of a property item or interest, such as tools, construction equipment, or other personal property owned by Contractor, a Subcontractor, or an employee of Contractor or a Subcontractor, then the entity or individual owning such property item will be responsible for deciding whether to insure it, and if so in what amount.

6.06 *Waiver of Rights*

- A. All policies purchased in accordance with Paragraph 6.05, expressly including the builder's risk policy, shall contain provisions to the effect that in the event of payment of any loss or damage the insurers will have no rights of recovery against any insureds thereunder, or against Engineer or its consultants, or their officers, directors, members, partners, employees, agents, consultants, or subcontractors. Owner and Contractor waive all rights against each other and the respective officers, directors, members, partners, employees, agents, consultants, and subcontractors of each and any of them, for all losses and damages caused by, arising out of, or resulting from any of the perils or causes of loss covered by such policies and any other property insurance applicable to the Work; and, in addition, waive all such rights against Engineer, its consultants, all Subcontractors, all individuals or entities identified in the Supplementary Conditions as insureds, and the officers, directors, members, partners, employees, agents, consultants, and subcontractors of each and any of them, under such policies for losses and damages so caused. None of the above waivers shall extend to the rights that any party making such waiver may have to the proceeds of insurance held by Owner or Contractor as trustee or fiduciary, or otherwise payable under any policy so issued.
- B. Owner waives all rights against Contractor, Subcontractors, and Engineer, and the officers, directors, members, partners, employees, agents, consultants and subcontractors of each and any of them, for:
 - 1. loss due to business interruption, loss of use, or other consequential loss extending beyond direct physical loss or damage to Owner's property or the Work caused by, arising out of, or resulting from fire or other perils whether or not insured by Owner; and
 - 2. loss or damage to the completed Project or part thereof caused by, arising out of, or resulting from fire or other insured peril or cause of loss covered by any property insurance maintained on the completed Project or part thereof by Owner during partial occupancy or use pursuant to Paragraph 15.04, after Substantial Completion pursuant to Paragraph 15.03, or after final payment pursuant to Paragraph 15.06.
- C. Any insurance policy maintained by Owner covering any loss, damage or consequential loss referred to in Paragraph 6.06.B shall contain provisions to the effect that in the event of payment of any such loss, damage, or consequential loss, the insurers will have no rights of recovery against Contractor, Subcontractors, or Engineer, or the officers, directors, members, partners, employees, agents, consultants, or subcontractors of each and any of them.
- D. Contractor shall be responsible for assuring that the agreement under which a Subcontractor performs a portion of the Work contains provisions whereby the Subcontractor waives all rights against Owner, Contractor, all individuals or entities identified in the Supplementary Conditions as insureds, the Engineer and its consultants, and the officers, directors, members, partners, employees, agents, consultants, and subcontractors of each and any of them, for all losses and damages caused by, arising out of, relating to, or resulting from any of the perils or causes of loss covered by builder's risk insurance and any other property insurance applicable to the Work.

6.07 *Receipt and Application of Property Insurance Proceeds*

- A. Any insured loss under the builder's risk and other policies of insurance required by Paragraph 6.05 will be adjusted and settled with the named insured that purchased the policy. Such named insured shall act as fiduciary for the other insureds, and give notice to such other insureds that adjustment and settlement of a claim is in progress. Any other insured may state its position regarding a claim for insured loss in writing within 15 days after notice of such claim.
- B. Proceeds for such insured losses may be made payable by the insurer either jointly to multiple insureds, or to the named insured that purchased the policy in its own right and as fiduciary for other insureds, subject to the requirements of any applicable mortgage clause. A named insured receiving insurance proceeds under the builder's risk and other policies of insurance required by Paragraph 6.05 shall distribute such proceeds in accordance with such agreement as the parties in interest may reach, or as otherwise required under the dispute resolution provisions of this Contract or applicable Laws and Regulations.
- C. If no other special agreement is reached, the damaged Work shall be repaired or replaced, the money so received applied on account thereof, and the Work and the cost thereof covered by Change Order, if needed.

ARTICLE 7 – CONTRACTOR'S RESPONSIBILITIES

7.01 *Supervision and Superintendence*

- A. Contractor shall supervise, inspect, and direct the Work competently and efficiently, devoting such attention thereto and applying such skills and expertise as may be necessary to perform the Work in accordance with the Contract Documents. Contractor shall be solely responsible for the means, methods, techniques, sequences, and procedures of construction.
- B. At all times during the progress of the Work, Contractor shall assign a competent resident superintendent who shall not be replaced without written notice to Owner and Engineer except under extraordinary circumstances.

7.02 *Labor; Working Hours*

- A. Contractor shall provide competent, suitably qualified personnel to survey and lay out the Work and perform construction as required by the Contract Documents. Contractor shall at all times maintain good discipline and order at the Site.
- B. Except as otherwise required for the safety or protection of persons or the Work or property at the Site or adjacent thereto, and except as otherwise stated in the Contract Documents, all Work at the Site shall be performed during regular working hours, Monday through Friday. Contractor will not perform Work on a Saturday, Sunday, or any legal holiday. Contractor may perform Work outside regular working hours or on Saturdays, Sundays, or legal holidays only with Owner's written consent, which will not be unreasonably withheld.

7.03 *Services, Materials, and Equipment*

- A. Unless otherwise specified in the Contract Documents, Contractor shall provide and assume full responsibility for all services, materials, equipment, labor, transportation, construction equipment and machinery, tools, appliances, fuel, power, light, heat, telephone, water, sanitary facilities, temporary facilities, and all other facilities and incidentals necessary for the performance, testing, start up, and completion of the Work, whether or not such items are specifically called for in the Contract Documents.
- B. All materials and equipment incorporated into the Work shall be of good quality and new, except as otherwise provided in the Contract Documents. All special warranties and guarantees required by

the Specifications shall expressly run to the benefit of Owner. If required by Engineer, Contractor shall furnish satisfactory evidence (including reports of required tests) as to the source, kind, and quality of materials and equipment.

- C. All materials and equipment shall be stored, applied, installed, connected, erected, protected, used, cleaned, and conditioned in accordance with instructions of the applicable Supplier, except as otherwise may be provided in the Contract Documents.

7.04 "Or Equals"

- A. Whenever an item of material or equipment is specified or described in the Contract Documents by using the name of a proprietary item or the name of a particular Supplier, the Contract Price has been based upon Contractor furnishing such item as specified. The specification or description of such an item is intended to establish the type, function, appearance, and quality required. Unless the specification or description contains or is followed by words reading that no like, equivalent, or "or equal" item is permitted, Contractor may request that Engineer authorize the use of other items of material or equipment, or items from other proposed suppliers under the circumstances described below.
 - 1. If Engineer in its sole discretion determines that an item of material or equipment proposed by Contractor is functionally equal to that named and sufficiently similar so that no change in related Work will be required, Engineer shall deem it an "or equal" item. For the purposes of this paragraph, a proposed item of material or equipment will be considered functionally equal to an item so named if:
 - a. in the exercise of reasonable judgment Engineer determines that:
 - 1) it is at least equal in materials of construction, quality, durability, appearance, strength, and design characteristics;
 - 2) it will reliably perform at least equally well the function and achieve the results imposed by the design concept of the completed Project as a functioning whole;
 - 3) it has a proven record of performance and availability of responsive service; and
 - 4) it is not objectionable to Owner.
 - b. Contractor certifies that, if approved and incorporated into the Work:
 - 1) there will be no increase in cost to the Owner or increase in Contract Times; and
 - 2) it will conform substantially to the detailed requirements of the item named in the Contract Documents.
- B. *Contractor's Expense:* Contractor shall provide all data in support of any proposed "or equal" item at Contractor's expense.
- C. *Engineer's Evaluation and Determination:* Engineer will be allowed a reasonable time to evaluate each "or-equal" request. Engineer may require Contractor to furnish additional data about the proposed "or-equal" item. Engineer will be the sole judge of acceptability. No "or-equal" item will be ordered, furnished, installed, or utilized until Engineer's review is complete and Engineer determines that the proposed item is an "or-equal", which will be evidenced by an approved Shop Drawing or other written communication. Engineer will advise Contractor in writing of any negative determination.
- D. *Effect of Engineer's Determination:* Neither approval nor denial of an "or-equal" request shall result in any change in Contract Price. The Engineer's denial of an "or-equal" request shall be final and binding, and may not be reversed through an appeal under any provision of the Contract Documents.

- E. *Treatment as a Substitution Request:* If Engineer determines that an item of material or equipment proposed by Contractor does not qualify as an “or-equal” item, Contractor may request that Engineer considered the proposed item as a substitute pursuant to Paragraph 7.05.

7.05 *Substitutes*

- A. Unless the specification or description of an item of material or equipment required to be furnished under the Contract Documents contains or is followed by words reading that no substitution is permitted, Contractor may request that Engineer authorize the use of other items of material or equipment under the circumstances described below. To the extent possible such requests shall be made before commencement of related construction at the Site.
1. Contractor shall submit sufficient information as provided below to allow Engineer to determine if the item of material or equipment proposed is functionally equivalent to that named and an acceptable substitute therefor. Engineer will not accept requests for review of proposed substitute items of material or equipment from anyone other than Contractor.
 2. The requirements for review by Engineer will be as set forth in Paragraph 7.05.B, as supplemented by the Specifications, and as Engineer may decide is appropriate under the circumstances.
 3. Contractor shall make written application to Engineer for review of a proposed substitute item of material or equipment that Contractor seeks to furnish or use. The application:
 - a. shall certify that the proposed substitute item will:
 - 1) perform adequately the functions and achieve the results called for by the general design,
 - 2) be similar in substance to that specified, and
 - 3) be suited to the same use as that specified.
 - b. will state:
 - 1) the extent, if any, to which the use of the proposed substitute item will necessitate a change in Contract Times,
 - 2) whether use of the proposed substitute item in the Work will require a change in any of the Contract Documents (or in the provisions of any other direct contract with Owner for other work on the Project) to adapt the design to the proposed substitute item, and
 - 3) whether incorporation or use of the proposed substitute item in connection with the Work is subject to payment of any license fee or royalty.
 - c. will identify:
 - 1) all variations of the proposed substitute item from that specified, and
 - 2) available engineering, sales, maintenance, repair, and replacement services.
 - d. shall contain an itemized estimate of all costs or credits that will result directly or indirectly from use of such substitute item, including but not limited to changes in Contract Price, shared savings, costs of redesign, and claims of other contractors affected by any resulting change.
- B. *Engineer’s Evaluation and Determination:* Engineer will be allowed a reasonable time to evaluate each substitute request, and to obtain comments and direction from Owner. Engineer may require Contractor to furnish additional data about the proposed substitute item. Engineer will be the sole judge of acceptability. No substitute will be ordered, furnished, installed, or utilized until Engineer’s

review is complete and Engineer determines that the proposed item is an acceptable substitute. Engineer's determination will be evidenced by a Field Order or a proposed Change Order accounting for the substitution itself and all related impacts, including changes in Contract Price or Contract Times. Engineer will advise Contractor in writing of any negative determination.

- C. *Special Guarantee*: Owner may require Contractor to furnish at Contractor's expense a special performance guarantee or other surety with respect to any substitute.
- D. *Reimbursement of Engineer's Cost*: Engineer will record Engineer's costs in evaluating a substitute proposed or submitted by Contractor. Whether or not Engineer approves a substitute so proposed or submitted by Contractor, Contractor shall reimburse Owner for the reasonable charges of Engineer for evaluating each such proposed substitute. Contractor shall also reimburse Owner for the reasonable charges of Engineer for making changes in the Contract Documents (or in the provisions of any other direct contract with Owner) resulting from the acceptance of each proposed substitute.
- E. *Contractor's Expense*: Contractor shall provide all data in support of any proposed substitute at Contractor's expense.
- F. *Effect of Engineer's Determination*: If Engineer approves the substitution request, Contractor shall execute the proposed Change Order and proceed with the substitution. The Engineer's denial of a substitution request shall be final and binding, and may not be reversed through an appeal under any provision of the Contract Documents. Contractor may challenge the scope of reimbursement costs imposed under Paragraph 7.05.D, by timely submittal of a Change Proposal.

7.06 *Concerning Subcontractors, Suppliers, and Others*

- A. Contractor may retain Subcontractors and Suppliers for the performance of parts of the Work. Such Subcontractors and Suppliers must be acceptable to Owner.
- B. Contractor shall retain specific Subcontractors, Suppliers, or other individuals or entities for the performance of designated parts of the Work if required by the Contract to do so.
- C. Subsequent to the submittal of Contractor's Bid or final negotiation of the terms of the Contract, Owner may not require Contractor to retain any Subcontractor, Supplier, or other individual or entity to furnish or perform any of the Work against which Contractor has reasonable objection.
- D. Prior to entry into any binding subcontract or purchase order, Contractor shall submit to Owner the identity of the proposed Subcontractor or Supplier (unless Owner has already deemed such proposed Subcontractor or Supplier acceptable, during the bidding process or otherwise). Such proposed Subcontractor or Supplier shall be deemed acceptable to Owner unless Owner raises a substantive, reasonable objection within five days.
- E. Owner may require the replacement of any Subcontractor, Supplier, or other individual or entity retained by Contractor to perform any part of the Work. Owner also may require Contractor to retain specific replacements; provided, however, that Owner may not require a replacement to which Contractor has a reasonable objection. If Contractor has submitted the identity of certain Subcontractors, Suppliers, or other individuals or entities for acceptance by Owner, and Owner has accepted it (either in writing or by failing to make written objection thereto), then Owner may subsequently revoke the acceptance of any such Subcontractor, Supplier, or other individual or entity so identified solely on the basis of substantive, reasonable objection after due investigation. Contractor shall submit an acceptable replacement for the rejected Subcontractor, Supplier, or other individual or entity.
- F. If Owner requires the replacement of any Subcontractor, Supplier, or other individual or entity retained by Contractor to perform any part of the Work, then Contractor shall be entitled to an adjustment in Contract Price or Contract Times, or both, with respect to the replacement; and

Contractor shall initiate a Change Proposal for such adjustment within 30 days of Owner's requirement of replacement.

- G. No acceptance by Owner of any such Subcontractor, Supplier, or other individual or entity, whether initially or as a replacement, shall constitute a waiver of the right of Owner to the completion of the Work in accordance with the Contract Documents.
- H. On a monthly basis Contractor shall submit to Engineer a complete list of all Subcontractors and Suppliers having a direct contract with Contractor, and of all other Subcontractors and Suppliers known to Contractor at the time of submittal.
- I. Contractor shall be fully responsible to Owner and Engineer for all acts and omissions of the Subcontractors, Suppliers, and other individuals or entities performing or furnishing any of the Work just as Contractor is responsible for Contractor's own acts and omissions.
- J. Contractor shall be solely responsible for scheduling and coordinating the work of Subcontractors, Suppliers, and all other individuals or entities performing or furnishing any of the Work.
- K. Contractor shall restrict all Subcontractors, Suppliers, and such other individuals or entities performing or furnishing any of the Work from communicating with Engineer or Owner, except through Contractor or in case of an emergency, or as otherwise expressly allowed herein.
- L. The divisions and sections of the Specifications and the identifications of any Drawings shall not control Contractor in dividing the Work among Subcontractors or Suppliers or delineating the Work to be performed by any specific trade.
- M. All Work performed for Contractor by a Subcontractor or Supplier shall be pursuant to an appropriate contractual agreement that specifically binds the Subcontractor or Supplier to the applicable terms and conditions of the Contract Documents for the benefit of Owner and Engineer.
- N. Owner may furnish to any Subcontractor or Supplier, to the extent practicable, information about amounts paid to Contractor on account of Work performed for Contractor by the particular Subcontractor or Supplier.
- O. Nothing in the Contract Documents:
 - 1. shall create for the benefit of any such Subcontractor, Supplier, or other individual or entity any contractual relationship between Owner or Engineer and any such Subcontractor, Supplier, or other individual or entity; nor
 - 2. shall create any obligation on the part of Owner or Engineer to pay or to see to the payment of any money due any such Subcontractor, Supplier, or other individual or entity except as may otherwise be required by Laws and Regulations.

7.07 *Patent Fees and Royalties*

- A. Contractor shall pay all license fees and royalties and assume all costs incident to the use in the performance of the Work or the incorporation in the Work of any invention, design, process, product, or device which is the subject of patent rights or copyrights held by others. If a particular invention, design, process, product, or device is specified in the Contract Documents for use in the performance of the Work and if, to the actual knowledge of Owner or Engineer, its use is subject to patent rights or copyrights calling for the payment of any license fee or royalty to others, the existence of such rights shall be disclosed by Owner in the Contract Documents.
- B. To the fullest extent permitted by Laws and Regulations, Owner shall indemnify and hold harmless Contractor, and its officers, directors, members, partners, employees, agents, consultants, and subcontractors from and against all claims, costs, losses, and damages (including but not limited to all fees and charges of engineers, architects, attorneys, and other professionals, and all court or

arbitration or other dispute resolution costs) arising out of or relating to any infringement of patent rights or copyrights incident to the use in the performance of the Work or resulting from the incorporation in the Work of any invention, design, process, product, or device specified in the Contract Documents, but not identified as being subject to payment of any license fee or royalty to others required by patent rights or copyrights.

- C. To the fullest extent permitted by Laws and Regulations, Contractor shall indemnify and hold harmless Owner and Engineer, and the officers, directors, members, partners, employees, agents, consultants and subcontractors of each and any of them from and against all claims, costs, losses, and damages (including but not limited to all fees and charges of engineers, architects, attorneys, and other professionals and all court or arbitration or other dispute resolution costs) arising out of or relating to any infringement of patent rights or copyrights incident to the use in the performance of the Work or resulting from the incorporation in the Work of any invention, design, process, product, or device not specified in the Contract Documents.

7.08 *Permits*

- A. Unless otherwise provided in the Contract Documents, Contractor shall obtain and pay for all construction permits and licenses. Owner shall assist Contractor, when necessary, in obtaining such permits and licenses. Contractor shall pay all governmental charges and inspection fees necessary for the prosecution of the Work which are applicable at the time of the submission of Contractor's Bid (or when Contractor became bound under a negotiated contract). Owner shall pay all charges of utility owners for connections for providing permanent service to the Work

7.09 *Taxes*

- A. Contractor shall pay all sales, consumer, use, and other similar taxes required to be paid by Contractor in accordance with the Laws and Regulations of the place of the Project which are applicable during the performance of the Work.

7.10 *Laws and Regulations*

- A. Contractor shall give all notices required by and shall comply with all Laws and Regulations applicable to the performance of the Work. Except where otherwise expressly required by applicable Laws and Regulations, neither Owner nor Engineer shall be responsible for monitoring Contractor's compliance with any Laws or Regulations.
- B. If Contractor performs any Work or takes any other action knowing or having reason to know that it is contrary to Laws or Regulations, Contractor shall bear all resulting costs and losses, and shall indemnify and hold harmless Owner and Engineer, and the officers, directors, members, partners, employees, agents, consultants, and subcontractors of each and any of them from and against all claims, costs, losses, and damages (including but not limited to all fees and charges of engineers, architects, attorneys, and other professionals and all court or arbitration or other dispute resolution costs) arising out of or relating to such Work or other action. It shall not be Contractor's responsibility to make certain that the Work described in the Contract Documents is in accordance with Laws and Regulations, but this shall not relieve Contractor of Contractor's obligations under Paragraph 3.03.
- C. Owner or Contractor may give notice to the other party of any changes after the submission of Contractor's Bid (or after the date when Contractor became bound under a negotiated contract) in Laws or Regulations having an effect on the cost or time of performance of the Work, including but not limited to changes in Laws or Regulations having an effect on procuring permits and on sales, use, value-added, consumption, and other similar taxes. If Owner and Contractor are unable to agree on entitlement to or on the amount or extent, if any, of any adjustment in Contract Price or Contract Times resulting from such changes, then within 30 days of such notice Contractor may submit a Change Proposal, or Owner may initiate a Claim.

7.11 *Record Documents*

- A. Contractor shall maintain in a safe place at the Site one printed record copy of all Drawings, Specifications, Addenda, Change Orders, Work Change Directives, Field Orders, written interpretations and clarifications, and approved Shop Drawings. Contractor shall keep such record documents in good order and annotate them to show changes made during construction. These record documents, together with all approved Samples, will be available to Engineer for reference. Upon completion of the Work, Contractor shall deliver these record documents to Engineer.

7.12 *Safety and Protection*

- A. Contractor shall be solely responsible for initiating, maintaining, and supervising all safety precautions and programs in connection with the Work. Such responsibility does not relieve Subcontractors of their responsibility for the safety of persons or property in the performance of their work, nor for compliance with applicable safety Laws and Regulations. Contractor shall take all necessary precautions for the safety of, and shall provide the necessary protection to prevent damage, injury, or loss to:
 - 1. all persons on the Site or who may be affected by the Work;
 - 2. all the Work and materials and equipment to be incorporated therein, whether in storage on or off the Site; and
 - 3. other property at the Site or adjacent thereto, including trees, shrubs, lawns, walks, pavements, roadways, structures, other work in progress, utilities, and Underground Facilities not designated for removal, relocation, or replacement in the course of construction.
- B. Contractor shall comply with all applicable Laws and Regulations relating to the safety of persons or property, or to the protection of persons or property from damage, injury, or loss; and shall erect and maintain all necessary safeguards for such safety and protection. Contractor shall notify Owner; the owners of adjacent property, Underground Facilities, and other utilities; and other contractors and utility owners performing work at or adjacent to the Site, when prosecution of the Work may affect them, and shall cooperate with them in the protection, removal, relocation, and replacement of their property or work in progress.
- C. Contractor shall comply with the applicable requirements of Owner's safety programs, if any. The Supplementary Conditions identify any Owner's safety programs that are applicable to the Work.
- D. Contractor shall inform Owner and Engineer of the specific requirements of Contractor's safety program with which Owner's and Engineer's employees and representatives must comply while at the Site.
- E. All damage, injury, or loss to any property referred to in Paragraph 7.12.A.2 or 7.12.A.3 caused, directly or indirectly, in whole or in part, by Contractor, any Subcontractor, Supplier, or any other individual or entity directly or indirectly employed by any of them to perform any of the Work, or anyone for whose acts any of them may be liable, shall be remedied by Contractor at its expense (except damage or loss attributable to the fault of Drawings or Specifications or to the acts or omissions of Owner or Engineer or anyone employed by any of them, or anyone for whose acts any of them may be liable, and not attributable, directly or indirectly, in whole or in part, to the fault or negligence of Contractor or any Subcontractor, Supplier, or other individual or entity directly or indirectly employed by any of them).
- F. Contractor's duties and responsibilities for safety and protection shall continue until such time as all the Work is completed and Engineer has issued a notice to Owner and Contractor in accordance with Paragraph 15.06.B that the Work is acceptable (except as otherwise expressly provided in connection with Substantial Completion).

- G. Contractor's duties and responsibilities for safety and protection shall resume whenever Contractor or any Subcontractor or Supplier returns to the Site to fulfill warranty or correction obligations, or to conduct other tasks arising from the Contract Documents.

7.13 *Safety Representative*

- A. Contractor shall designate a qualified and experienced safety representative at the Site whose duties and responsibilities shall be the prevention of accidents and the maintaining and supervising of safety precautions and programs.

7.14 *Hazard Communication Programs*

- A. Contractor shall be responsible for coordinating any exchange of material safety data sheets or other hazard communication information required to be made available to or exchanged between or among employers at the Site in accordance with Laws or Regulations.

7.15 *Emergencies*

- A. In emergencies affecting the safety or protection of persons or the Work or property at the Site or adjacent thereto, Contractor is obligated to act to prevent threatened damage, injury, or loss. Contractor shall give Engineer prompt written notice if Contractor believes that any significant changes in the Work or variations from the Contract Documents have been caused thereby or are required as a result thereof. If Engineer determines that a change in the Contract Documents is required because of the action taken by Contractor in response to such an emergency, a Work Change Directive or Change Order will be issued.

7.16 *Shop Drawings, Samples, and Other Submittals*

A. *Shop Drawing and Sample Submittal Requirements:*

1. Before submitting a Shop Drawing or Sample, Contractor shall have:
 - a. reviewed and coordinated the Shop Drawing or Sample with other Shop Drawings and Samples and with the requirements of the Work and the Contract Documents;
 - b. determined and verified all field measurements, quantities, dimensions, specified performance and design criteria, installation requirements, materials, catalog numbers, and similar information with respect thereto;
 - c. determined and verified the suitability of all materials and equipment offered with respect to the indicated application, fabrication, shipping, handling, storage, assembly, and installation pertaining to the performance of the Work; and
 - d. determined and verified all information relative to Contractor's responsibilities for means, methods, techniques, sequences, and procedures of construction, and safety precautions and programs incident thereto.
2. Each submittal shall bear a stamp or specific written certification that Contractor has satisfied Contractor's obligations under the Contract Documents with respect to Contractor's review of that submittal, and that Contractor approves the submittal.
3. With each submittal, Contractor shall give Engineer specific written notice of any variations that the Shop Drawing or Sample may have from the requirements of the Contract Documents. This notice shall be set forth in a written communication separate from the Shop Drawings or Sample submittal; and, in addition, in the case of Shop Drawings by a specific notation made on each Shop Drawing submitted to Engineer for review and approval of each such variation.

- B. *Submittal Procedures for Shop Drawings and Samples:* Contractor shall submit Shop Drawings and Samples to Engineer for review and approval in accordance with the accepted Schedule of Submittals. Each submittal will be identified as Engineer may require.

1. *Shop Drawings:*
 - a. Contractor shall submit the number of copies required in the Specifications.
 - b. Data shown on the Shop Drawings will be complete with respect to quantities, dimensions, specified performance and design criteria, materials, and similar data to show Engineer the services, materials, and equipment Contractor proposes to provide and to enable Engineer to review the information for the limited purposes required by Paragraph 7.16.D.
2. *Samples:*
 - a. Contractor shall submit the number of Samples required in the Specifications.
 - b. Contractor shall clearly identify each Sample as to material, Supplier, pertinent data such as catalog numbers, the use for which intended and other data as Engineer may require to enable Engineer to review the submittal for the limited purposes required by Paragraph 7.16.D.
3. Where a Shop Drawing or Sample is required by the Contract Documents or the Schedule of Submittals, any related Work performed prior to Engineer's review and approval of the pertinent submittal will be at the sole expense and responsibility of Contractor.
- C. *Other Submittals:* Contractor shall submit other submittals to Engineer in accordance with the accepted Schedule of Submittals, and pursuant to the applicable terms of the Specifications.
- D. *Engineer's Review:*
 1. Engineer will provide timely review of Shop Drawings and Samples in accordance with the Schedule of Submittals acceptable to Engineer. Engineer's review and approval will be only to determine if the items covered by the submittals will, after installation or incorporation in the Work, conform to the information given in the Contract Documents and be compatible with the design concept of the completed Project as a functioning whole as indicated by the Contract Documents.
 2. Engineer's review and approval will not extend to means, methods, techniques, sequences, or procedures of construction or to safety precautions or programs incident thereto.
 3. Engineer's review and approval of a separate item as such will not indicate approval of the assembly in which the item functions.
 4. Engineer's review and approval of a Shop Drawing or Sample shall not relieve Contractor from responsibility for any variation from the requirements of the Contract Documents unless Contractor has complied with the requirements of Paragraph 7.16.A.3 and Engineer has given written approval of each such variation by specific written notation thereof incorporated in or accompanying the Shop Drawing or Sample. Engineer will document any such approved variation from the requirements of the Contract Documents in a Field Order.
 5. Engineer's review and approval of a Shop Drawing or Sample shall not relieve Contractor from responsibility for complying with the requirements of Paragraph 7.16.A and B.
 6. Engineer's review and approval of a Shop Drawing or Sample, or of a variation from the requirements of the Contract Documents, shall not, under any circumstances, change the Contract Times or Contract Price, unless such changes are included in a Change Order.
 7. Neither Engineer's receipt, review, acceptance or approval of a Shop Drawing, Sample, or other submittal shall result in such item becoming a Contract Document.
 8. Contractor shall perform the Work in compliance with the requirements and commitments set forth in approved Shop Drawings and Samples, subject to the provisions of Paragraph 7.16.D.4.

E. *Resubmittal Procedures:*

1. Contractor shall make corrections required by Engineer and shall return the required number of corrected copies of Shop Drawings and submit, as required, new Samples for review and approval. Contractor shall direct specific attention in writing to revisions other than the corrections called for by Engineer on previous submittals.
2. Contractor shall furnish required submittals with sufficient information and accuracy to obtain required approval of an item with no more than three submittals. Engineer will record Engineer's time for reviewing a fourth or subsequent submittal of a Shop Drawings, sample, or other item requiring approval, and Contractor shall be responsible for Engineer's charges to Owner for such time. Owner may impose a set-off against payments due to Contractor to secure reimbursement for such charges.
3. If Contractor requests a change of a previously approved submittal item, Contractor shall be responsible for Engineer's charges to Owner for its review time, and Owner may impose a set-off against payments due to Contractor to secure reimbursement for such charges, unless the need for such change is beyond the control of Contractor.

7.17 *Contractor's General Warranty and Guarantee*

- A. Contractor warrants and guarantees to Owner that all Work will be in accordance with the Contract Documents and will not be defective. Engineer and its officers, directors, members, partners, employees, agents, consultants, and subcontractors shall be entitled to rely on Contractor's warranty and guarantee.
- B. Contractor's warranty and guarantee hereunder excludes defects or damage caused by:
 1. abuse, modification, or improper maintenance or operation by persons other than Contractor, Subcontractors, Suppliers, or any other individual or entity for whom Contractor is responsible; or
 2. normal wear and tear under normal usage.
- C. Contractor's obligation to perform and complete the Work in accordance with the Contract Documents shall be absolute. None of the following will constitute an acceptance of Work that is not in accordance with the Contract Documents or a release of Contractor's obligation to perform the Work in accordance with the Contract Documents:
 1. observations by Engineer;
 2. recommendation by Engineer or payment by Owner of any progress or final payment;
 3. the issuance of a certificate of Substantial Completion by Engineer or any payment related thereto by Owner;
 4. use or occupancy of the Work or any part thereof by Owner;
 5. any review and approval of a Shop Drawing or Sample submittal;
 6. the issuance of a notice of acceptability by Engineer;
 7. any inspection, test, or approval by others; or
 8. any correction of defective Work by Owner.
- D. If the Contract requires the Contractor to accept the assignment of a contract entered into by Owner, then the specific warranties, guarantees, and correction obligations contained in the assigned contract shall govern with respect to Contractor's performance obligations to Owner for the Work described in the assigned contract.

7.18 *Indemnification*

- A. To the fullest extent permitted by Laws and Regulations, and in addition to any other obligations of Contractor under the Contract or otherwise, Contractor shall indemnify and hold harmless Owner and Engineer, and the officers, directors, members, partners, employees, agents, consultants and subcontractors of each and any of them from and against all claims, costs, losses, and damages (including but not limited to all fees and charges of engineers, architects, attorneys, and other professionals and all court or arbitration or other dispute resolution costs) arising out of or relating to the performance of the Work, provided that any such claim, cost, loss, or damage is attributable to bodily injury, sickness, disease, or death, or to injury to or destruction of tangible property (other than the Work itself), including the loss of use resulting therefrom but only to the extent caused by any negligent act or omission of Contractor, any Subcontractor, any Supplier, or any individual or entity directly or indirectly employed by any of them to perform any of the Work or anyone for whose acts any of them may be liable.
- B. In any and all claims against Owner or Engineer or any of their officers, directors, members, partners, employees, agents, consultants, or subcontractors by any employee (or the survivor or personal representative of such employee) of Contractor, any Subcontractor, any Supplier, or any individual or entity directly or indirectly employed by any of them to perform any of the Work, or anyone for whose acts any of them may be liable, the indemnification obligation under Paragraph 7.18.A shall not be limited in any way by any limitation on the amount or type of damages, compensation, or benefits payable by or for Contractor or any such Subcontractor, Supplier, or other individual or entity under workers' compensation acts, disability benefit acts, or other employee benefit acts.
- C. The indemnification obligations of Contractor under Paragraph 7.18.A shall not extend to the liability of Engineer and Engineer's officers, directors, members, partners, employees, agents, consultants and subcontractors arising out of:
 - 1. the preparation or approval of, or the failure to prepare or approve maps, Drawings, opinions, reports, surveys, Change Orders, designs, or Specifications; or
 - 2. giving directions or instructions, or failing to give them, if that is the primary cause of the injury or damage.

7.19 *Delegation of Professional Design Services*

- A. Contractor will not be required to provide professional design services unless such services are specifically required by the Contract Documents for a portion of the Work or unless such services are required to carry out Contractor's responsibilities for construction means, methods, techniques, sequences and procedures. Contractor shall not be required to provide professional services in violation of applicable Laws and Regulations.
- B. If professional design services or certifications by a design professional related to systems, materials, or equipment are specifically required of Contractor by the Contract Documents, Owner and Engineer will specify all performance and design criteria that such services must satisfy. Contractor shall cause such services or certifications to be provided by a properly licensed professional, whose signature and seal shall appear on all drawings, calculations, specifications, certifications, and other submittals prepared by such professional. Shop Drawings and other submittals related to the Work designed or certified by such professional, if prepared by others, shall bear such professional's written approval when submitted to Engineer.
- C. Owner and Engineer shall be entitled to rely upon the adequacy, accuracy, and completeness of the services, certifications, or approvals performed by such design professionals, provided Owner and Engineer have specified to Contractor all performance and design criteria that such services must satisfy.

- D. Pursuant to this paragraph, Engineer's review and approval of design calculations and design drawings will be only for the limited purpose of checking for conformance with performance and design criteria given and the design concept expressed in the Contract Documents. Engineer's review and approval of Shop Drawings and other submittals (except design calculations and design drawings) will be only for the purpose stated in Paragraph 7.16.D.1.
- E. Contractor shall not be responsible for the adequacy of the performance or design criteria specified by Owner or Engineer.

ARTICLE 8 – OTHER WORK AT THE SITE

8.01 *Other Work*

- A. In addition to and apart from the Work under the Contract Documents, the Owner may perform other work at or adjacent to the Site. Such other work may be performed by Owner's employees, or through contracts between the Owner and third parties. Owner may also arrange to have third-party utility owners perform work on their utilities and facilities at or adjacent to the Site.
- B. If Owner performs other work at or adjacent to the Site with Owner's employees, or through contracts for such other work, then Owner shall give Contractor written notice thereof prior to starting any such other work. If Owner has advance information regarding the start of any utility work at or adjacent to the Site, Owner shall provide such information to Contractor.
- C. Contractor shall afford each other contractor that performs such other work, each utility owner performing other work, and Owner, if Owner is performing other work with Owner's employees, proper and safe access to the Site, and provide a reasonable opportunity for the introduction and storage of materials and equipment and the execution of such other work. Contractor shall do all cutting, fitting, and patching of the Work that may be required to properly connect or otherwise make its several parts come together and properly integrate with such other work. Contractor shall not endanger any work of others by cutting, excavating, or otherwise altering such work; provided, however, that Contractor may cut or alter others' work with the written consent of Engineer and the others whose work will be affected.
- D. If the proper execution or results of any part of Contractor's Work depends upon work performed by others under this Article 8, Contractor shall inspect such other work and promptly report to Engineer in writing any delays, defects, or deficiencies in such other work that render it unavailable or unsuitable for the proper execution and results of Contractor's Work. Contractor's failure to so report will constitute an acceptance of such other work as fit and proper for integration with Contractor's Work except for latent defects and deficiencies in such other work.

8.02 *Coordination*

- A. If Owner intends to contract with others for the performance of other work at or adjacent to the Site, to perform other work at or adjacent to the Site with Owner's employees, or to arrange to have utility owners perform work at or adjacent to the Site, the following will be set forth in the Supplementary Conditions or provided to Contractor prior to the start of any such other work:
 - 1. the identity of the individual or entity that will have authority and responsibility for coordination of the activities among the various contractors;
 - 2. an itemization of the specific matters to be covered by such authority and responsibility; and
 - 3. the extent of such authority and responsibilities.
- B. Unless otherwise provided in the Supplementary Conditions, Owner shall have sole authority and responsibility for such coordination.

8.03 *Legal Relationships*

- A. If, in the course of performing other work at or adjacent to the Site for Owner, the Owner's employees, any other contractor working for Owner, or any utility owner for whom the Owner is responsible causes damage to the Work or to the property of Contractor or its Subcontractors, or delays, disrupts, interferes with, or increases the scope or cost of the performance of the Work, through actions or inaction, then Contractor shall be entitled to an equitable adjustment in the Contract Price or the Contract Times, or both. Contractor must submit any Change Proposal seeking an equitable adjustment in the Contract Price or the Contract Times under this paragraph within 30 days of the damaging, delaying, disrupting, or interfering event. The entitlement to, and extent of, any such equitable adjustment shall take into account information (if any) regarding such other work that was provided to Contractor in the Contract Documents prior to the submittal of the Bid or the final negotiation of the terms of the Contract. When applicable, any such equitable adjustment in Contract Price shall be conditioned on Contractor assigning to Owner all Contractor's rights against such other contractor or utility owner with respect to the damage, delay, disruption, or interference that is the subject of the adjustment. Contractor's entitlement to an adjustment of the Contract Times is conditioned on such adjustment being essential to Contractor's ability to complete the Work within the Contract Times.
- B. Contractor shall take reasonable and customary measures to avoid damaging, delaying, disrupting, or interfering with the work of Owner, any other contractor, or any utility owner performing other work at or adjacent to the Site. If Contractor fails to take such measures and as a result damages, delays, disrupts, or interferes with the work of any such other contractor or utility owner, then Owner may impose a set-off against payments due to Contractor, and assign to such other contractor or utility owner the Owner's contractual rights against Contractor with respect to the breach of the obligations set forth in this paragraph.
- C. When Owner is performing other work at or adjacent to the Site with Owner's employees, Contractor shall be liable to Owner for damage to such other work, and for the reasonable direct delay, disruption, and interference costs incurred by Owner as a result of Contractor's failure to take reasonable and customary measures with respect to Owner's other work. In response to such damage, delay, disruption, or interference, Owner may impose a set-off against payments due to Contractor.
- D. If Contractor damages, delays, disrupts, or interferes with the work of any other contractor, or any utility owner performing other work at or adjacent to the Site, through Contractor's failure to take reasonable and customary measures to avoid such impacts, or if any claim arising out of Contractor's actions, inactions, or negligence in performance of the Work at or adjacent to the Site is made by any such other contractor or utility owner against Contractor, Owner, or Engineer, then Contractor shall (1) promptly attempt to settle the claim as to all parties through negotiations with such other contractor or utility owner, or otherwise resolve the claim by arbitration or other dispute resolution proceeding or at law, and (2) indemnify and hold harmless Owner and Engineer, and the officers, directors, members, partners, employees, agents, consultants and subcontractors of each and any of them from and against any such claims, and against all costs, losses, and damages (including but not limited to all fees and charges of engineers, architects, attorneys, and other professionals and all court or arbitration or other dispute resolution costs) arising out of or relating to such damage, delay, disruption, or interference.

ARTICLE 9 – OWNER'S RESPONSIBILITIES

9.01 *Communications to Contractor*

- A. Except as otherwise provided in these General Conditions, Owner shall issue all communications to Contractor through Engineer.

9.02 *Replacement of Engineer*

- A. Owner may at its discretion appoint an engineer to replace Engineer, provided Contractor makes no reasonable objection to the replacement engineer. The replacement engineer's status under the Contract Documents shall be that of the former Engineer.

9.03 *Furnish Data*

- A. Owner shall promptly furnish the data required of Owner under the Contract Documents.

9.04 *Pay When Due*

- A. Owner shall make payments to Contractor when they are due as provided in the Agreement.

9.05 *Lands and Easements; Reports, Tests, and Drawings*

- A. Owner's duties with respect to providing lands and easements are set forth in Paragraph 5.01.
- B. Owner's duties with respect to providing engineering surveys to establish reference points are set forth in Paragraph 4.03.
- C. Article 5 refers to Owner's identifying and making available to Contractor copies of reports of explorations and tests of conditions at the Site, and drawings of physical conditions relating to existing surface or subsurface structures at the Site.

9.06 *Insurance*

- A. Owner's responsibilities, if any, with respect to purchasing and maintaining liability and property insurance are set forth in Article 6.

9.07 *Change Orders*

- A. Owner's responsibilities with respect to Change Orders are set forth in Article 11.

9.08 *Inspections, Tests, and Approvals*

- A. Owner's responsibility with respect to certain inspections, tests, and approvals is set forth in Paragraph 14.02.B.

9.09 *Limitations on Owner's Responsibilities*

- A. The Owner shall not supervise, direct, or have control or authority over, nor be responsible for, Contractor's means, methods, techniques, sequences, or procedures of construction, or the safety precautions and programs incident thereto, or for any failure of Contractor to comply with Laws and Regulations applicable to the performance of the Work. Owner will not be responsible for Contractor's failure to perform the Work in accordance with the Contract Documents.

9.10 *Undisclosed Hazardous Environmental Condition*

- A. Owner's responsibility in respect to an undisclosed Hazardous Environmental Condition is set forth in Paragraph 5.06.

9.11 *Evidence of Financial Arrangements*

- A. Upon request of Contractor, Owner shall furnish Contractor reasonable evidence that financial arrangements have been made to satisfy Owner's obligations under the Contract Documents (including obligations under proposed changes in the Work).

9.12 *Safety Programs*

- A. While at the Site, Owner's employees and representatives shall comply with the specific applicable requirements of Contractor's safety programs of which Owner has been informed.
- B. Owner shall furnish copies of any applicable Owner safety programs to Contractor.

ARTICLE 10 – ENGINEER’S STATUS DURING CONSTRUCTION

10.01 *Owner’s Representative*

- A. Engineer will be Owner’s representative during the construction period. The duties and responsibilities and the limitations of authority of Engineer as Owner’s representative during construction are set forth in the Contract.

10.02 *Visits to Site*

- A. Engineer will make visits to the Site at intervals appropriate to the various stages of construction as Engineer deems necessary in order to observe as an experienced and qualified design professional the progress that has been made and the quality of the various aspects of Contractor’s executed Work. Based on information obtained during such visits and observations, Engineer, for the benefit of Owner, will determine, in general, if the Work is proceeding in accordance with the Contract Documents. Engineer will not be required to make exhaustive or continuous inspections on the Site to check the quality or quantity of the Work. Engineer’s efforts will be directed toward providing for Owner a greater degree of confidence that the completed Work will conform generally to the Contract Documents. On the basis of such visits and observations, Engineer will keep Owner informed of the progress of the Work and will endeavor to guard Owner against defective Work.
- B. Engineer’s visits and observations are subject to all the limitations on Engineer’s authority and responsibility set forth in Paragraph 10.08. Particularly, but without limitation, during or as a result of Engineer’s visits or observations of Contractor’s Work, Engineer will not supervise, direct, control, or have authority over or be responsible for Contractor’s means, methods, techniques, sequences, or procedures of construction, or the safety precautions and programs incident thereto, or for any failure of Contractor to comply with Laws and Regulations applicable to the performance of the Work.

10.03 *Project Representative*

- A. If Owner and Engineer have agreed that Engineer will furnish a Resident Project Representative to represent Engineer at the Site and assist Engineer in observing the progress and quality of the Work, then the authority and responsibilities of any such Resident Project Representative will be as provided in the Supplementary Conditions, and limitations on the responsibilities thereof will be as provided in Paragraph 10.08. If Owner designates another representative or agent to represent Owner at the Site who is not Engineer’s consultant, agent, or employee, the responsibilities and authority and limitations thereon of such other individual or entity will be as provided in the Supplementary Conditions.

10.04 *Rejecting Defective Work*

- A. Engineer has the authority to reject Work in accordance with Article 14.

10.05 *Shop Drawings, Change Orders and Payments*

- A. Engineer’s authority, and limitations thereof, as to Shop Drawings and Samples, are set forth in Paragraph 7.16.
- B. Engineer’s authority, and limitations thereof, as to design calculations and design drawings submitted in response to a delegation of professional design services, if any, are set forth in Paragraph 7.19.
- C. Engineer’s authority as to Change Orders is set forth in Article 11.
- D. Engineer’s authority as to Applications for Payment is set forth in Article 15.

10.06 *Determinations for Unit Price Work*

- A. Engineer will determine the actual quantities and classifications of Unit Price Work performed by Contractor as set forth in Paragraph 13.03.

10.07 *Decisions on Requirements of Contract Documents and Acceptability of Work*

- A. Engineer will render decisions regarding the requirements of the Contract Documents, and judge the acceptability of the Work, pursuant to the specific procedures set forth herein for initial interpretations, Change Proposals, and acceptance of the Work. In rendering such decisions and judgments, Engineer will not show partiality to Owner or Contractor, and will not be liable to Owner, Contractor, or others in connection with any proceedings, interpretations, decisions, or judgments conducted or rendered in good faith.

10.08 *Limitations on Engineer's Authority and Responsibilities*

- A. Neither Engineer's authority or responsibility under this Article 10 or under any other provision of the Contract, nor any decision made by Engineer in good faith either to exercise or not exercise such authority or responsibility or the undertaking, exercise, or performance of any authority or responsibility by Engineer, shall create, impose, or give rise to any duty in contract, tort, or otherwise owed by Engineer to Contractor, any Subcontractor, any Supplier, any other individual or entity, or to any surety for or employee or agent of any of them.
- B. Engineer will not supervise, direct, control, or have authority over or be responsible for Contractor's means, methods, techniques, sequences, or procedures of construction, or the safety precautions and programs incident thereto, or for any failure of Contractor to comply with Laws and Regulations applicable to the performance of the Work. Engineer will not be responsible for Contractor's failure to perform the Work in accordance with the Contract Documents.
- C. Engineer will not be responsible for the acts or omissions of Contractor or of any Subcontractor, any Supplier, or of any other individual or entity performing any of the Work.
- D. Engineer's review of the final Application for Payment and accompanying documentation and all maintenance and operating instructions, schedules, guarantees, bonds, certificates of inspection, tests and approvals, and other documentation required to be delivered by Paragraph 15.06.A will only be to determine generally that their content complies with the requirements of, and in the case of certificates of inspections, tests, and approvals, that the results certified indicate compliance with the Contract Documents.
- E. The limitations upon authority and responsibility set forth in this Paragraph 10.08 shall also apply to the Resident Project Representative, if any.

10.09 *Compliance with Safety Program*

- A. While at the Site, Engineer's employees and representatives will comply with the specific applicable requirements of Owner's and Contractor's safety programs (if any) of which Engineer has been informed.

ARTICLE 11 – AMENDING THE CONTRACT DOCUMENTS; CHANGES IN THE WORK

11.01 *Amending and Supplementing Contract Documents*

- A. The Contract Documents may be amended or supplemented by a Change Order, a Work Change Directive, or a Field Order.
 - 1. *Change Orders:*
 - a. If an amendment or supplement to the Contract Documents includes a change in the Contract Price or the Contract Times, such amendment or supplement must be set forth

in a Change Order. A Change Order also may be used to establish amendments and supplements of the Contract Documents that do not affect the Contract Price or Contract Times.

- b. Owner and Contractor may amend those terms and conditions of the Contract Documents that do not involve (1) the performance or acceptability of the Work, (2) the design (as set forth in the Drawings, Specifications, or otherwise), or (3) other engineering or technical matters, without the recommendation of the Engineer. Such an amendment shall be set forth in a Change Order.
2. *Work Change Directives:* A Work Change Directive will not change the Contract Price or the Contract Times but is evidence that the parties expect that the modification ordered or documented by a Work Change Directive will be incorporated in a subsequently issued Change Order, following negotiations by the parties as to the Work Change Directive's effect, if any, on the Contract Price and Contract Times; or, if negotiations are unsuccessful, by a determination under the terms of the Contract Documents governing adjustments, expressly including Paragraph 11.04 regarding change of Contract Price. Contractor must submit any Change Proposal seeking an adjustment of the Contract Price or the Contract Times, or both, no later than 30 days after the completion of the Work set out in the Work Change Directive. Owner must submit any Claim seeking an adjustment of the Contract Price or the Contract Times, or both, no later than 60 days after issuance of the Work Change Directive.
 3. *Field Orders:* Engineer may authorize minor changes in the Work if the changes do not involve an adjustment in the Contract Price or the Contract Times and are compatible with the design concept of the completed Project as a functioning whole as indicated by the Contract Documents. Such changes will be accomplished by a Field Order and will be binding on Owner and also on Contractor, which shall perform the Work involved promptly. If Contractor believes that a Field Order justifies an adjustment in the Contract Price or Contract Times, or both, then before proceeding with the Work at issue, Contractor shall submit a Change Proposal as provided herein.

11.02 *Owner-Authorized Changes in the Work*

- A. Without invalidating the Contract and without notice to any surety, Owner may, at any time or from time to time, order additions, deletions, or revisions in the Work. Such changes shall be supported by Engineer's recommendation, to the extent the change involves the design (as set forth in the Drawings, Specifications, or otherwise), or other engineering or technical matters. Such changes may be accomplished by a Change Order, if Owner and Contractor have agreed as to the effect, if any, of the changes on Contract Times or Contract Price; or by a Work Change Directive. Upon receipt of any such document, Contractor shall promptly proceed with the Work involved; or, in the case of a deletion in the Work, promptly cease construction activities with respect to such deleted Work. Added or revised Work shall be performed under the applicable conditions of the Contract Documents. Nothing in this paragraph shall obligate Contractor to undertake work that Contractor reasonably concludes cannot be performed in a manner consistent with Contractor's safety obligations under the Contract Documents or Laws and Regulations.

11.03 *Unauthorized Changes in the Work*

- A. Contractor shall not be entitled to an increase in the Contract Price or an extension of the Contract Times with respect to any work performed that is not required by the Contract Documents, as amended, modified, or supplemented, except in the case of an emergency as provided in Paragraph 7.15 or in the case of uncovering Work as provided in Paragraph 14.05.

11.04 *Change of Contract Price*

- A. The Contract Price may only be changed by a Change Order. Any Change Proposal for an adjustment in the Contract Price shall comply with the provisions of Paragraph 11.06. Any Claim for an adjustment of Contract Price shall comply with the provisions of Article 12.
- B. An adjustment in the Contract Price will be determined as follows:
 - 1. where the Work involved is covered by unit prices contained in the Contract Documents, then by application of such unit prices to the quantities of the items involved (subject to the provisions of Paragraph 13.03); or
 - 2. where the Work involved is not covered by unit prices contained in the Contract Documents, then by a mutually agreed lump sum (which may include an allowance for overhead and profit not necessarily in accordance with Paragraph 11.04.C.2); or
 - 3. where the Work involved is not covered by unit prices contained in the Contract Documents and the parties do not reach mutual agreement to a lump sum, then on the basis of the Cost of the Work (determined as provided in Paragraph 13.01) plus a Contractor's fee for overhead and profit (determined as provided in Paragraph 11.04.C).
- C. *Contractor's Fee*: When applicable, the Contractor's fee for overhead and profit shall be determined as follows:
 - 1. a mutually acceptable fixed fee; or
 - 2. if a fixed fee is not agreed upon, then a fee based on the following percentages of the various portions of the Cost of the Work:
 - a. for costs incurred under Paragraphs 13.01.B.1 and 13.01.B.2, the Contractor's fee shall be 15 percent;
 - b. for costs incurred under Paragraph 13.01.B.3, the Contractor's fee shall be five percent;
 - c. where one or more tiers of subcontracts are on the basis of Cost of the Work plus a fee and no fixed fee is agreed upon, the intent of Paragraphs 11.04.C.2.a and 11.04.C.2.b is that the Contractor's fee shall be based on: (1) a fee of 15 percent of the costs incurred under Paragraphs 13.01.A.1 and 13.01.A.2 by the Subcontractor that actually performs the Work, at whatever tier, and (2) with respect to Contractor itself and to any Subcontractors of a tier higher than that of the Subcontractor that actually performs the Work, a fee of five percent of the amount (fee plus underlying costs incurred) attributable to the next lower tier Subcontractor; provided, however, that for any such subcontracted work the maximum total fee to be paid by Owner shall be no greater than 27 percent of the costs incurred by the Subcontractor that actually performs the work;
 - d. no fee shall be payable on the basis of costs itemized under Paragraphs 13.01.B.4, 13.01.B.5, and 13.01.C;
 - e. the amount of credit to be allowed by Contractor to Owner for any change which results in a net decrease in cost will be the amount of the actual net decrease in cost plus a deduction in Contractor's fee by an amount equal to five percent of such net decrease; and
 - f. when both additions and credits are involved in any one change, the adjustment in Contractor's fee shall be computed on the basis of the net change in accordance with Paragraphs 11.04.C.2.a through 11.04.C.2.e, inclusive.

11.05 *Change of Contract Times*

- A. The Contract Times may only be changed by a Change Order. Any Change Proposal for an adjustment in the Contract Times shall comply with the provisions of Paragraph 11.06. Any Claim for an adjustment in the Contract Times shall comply with the provisions of Article 12.
- B. An adjustment of the Contract Times shall be subject to the limitations set forth in Paragraph 4.05, concerning delays in Contractor's progress.

11.06 *Change Proposals*

- A. Contractor shall submit a Change Proposal to Engineer to request an adjustment in the Contract Times or Contract Price; appeal an initial decision by Engineer concerning the requirements of the Contract Documents or relating to the acceptability of the Work under the Contract Documents; contest a set-off against payment due; or seek other relief under the Contract. The Change Proposal shall specify any proposed change in Contract Times or Contract Price, or both, or other proposed relief, and explain the reason for the proposed change, with citations to any governing or applicable provisions of the Contract Documents.
 - 1. *Procedures:* Contractor shall submit each Change Proposal to Engineer promptly (but in no event later than 30 days) after the start of the event giving rise thereto, or after such initial decision. The Contractor shall submit supporting data, including the proposed change in Contract Price or Contract Time (if any), to the Engineer and Owner within 15 days after the submittal of the Change Proposal. The supporting data shall be accompanied by a written statement that the supporting data are accurate and complete, and that any requested time or price adjustment is the entire adjustment to which Contractor believes it is entitled as a result of said event. Engineer will advise Owner regarding the Change Proposal, and consider any comments or response from Owner regarding the Change Proposal.
 - 2. *Engineer's Action:* Engineer will review each Change Proposal and, within 30 days after receipt of the Contractor's supporting data, either deny the Change Proposal in whole, approve it in whole, or deny it in part and approve it in part. Such actions shall be in writing, with a copy provided to Owner and Contractor. If Engineer does not take action on the Change Proposal within 30 days, then either Owner or Contractor may at any time thereafter submit a letter to the other party indicating that as a result of Engineer's inaction the Change Proposal is deemed denied, thereby commencing the time for appeal of the denial under Article 12.
 - 3. *Binding Decision:* Engineer's decision will be final and binding upon Owner and Contractor, unless Owner or Contractor appeals the decision by filing a Claim under Article 12.
- B. *Resolution of Certain Change Proposals:* If the Change Proposal does not involve the design (as set forth in the Drawings, Specifications, or otherwise), the acceptability of the Work, or other engineering or technical matters, then Engineer will notify the parties that the Engineer is unable to resolve the Change Proposal. For purposes of further resolution of such a Change Proposal, such notice shall be deemed a denial, and Contractor may choose to seek resolution under the terms of Article 12.

11.07 *Execution of Change Orders*

- A. Owner and Contractor shall execute appropriate Change Orders covering:
 - 1. changes in the Contract Price or Contract Times which are agreed to by the parties, including any undisputed sum or amount of time for Work actually performed in accordance with a Work Change Directive;
 - 2. changes in Contract Price resulting from an Owner set-off, unless Contractor has duly contested such set-off;

3. changes in the Work which are: (a) ordered by Owner pursuant to Paragraph 11.02, (b) required because of Owner's acceptance of defective Work under Paragraph 14.04 or Owner's correction of defective Work under Paragraph 14.07, or (c) agreed to by the parties, subject to the need for Engineer's recommendation if the change in the Work involves the design (as set forth in the Drawings, Specifications, or otherwise), or other engineering or technical matters; and
 4. changes in the Contract Price or Contract Times, or other changes, which embody the substance of any final and binding results under Paragraph 11.06, or Article 12.
- B. If Owner or Contractor refuses to execute a Change Order that is required to be executed under the terms of this Paragraph 11.07, it shall be deemed to be of full force and effect, as if fully executed.

11.08 *Notification to Surety*

- A. If the provisions of any bond require notice to be given to a surety of any change affecting the general scope of the Work or the provisions of the Contract Documents (including, but not limited to, Contract Price or Contract Times), the giving of any such notice will be Contractor's responsibility. The amount of each applicable bond will be adjusted to reflect the effect of any such change.

ARTICLE 12 – CLAIMS

12.01 *Claims*

- A. *Claims Process:* The following disputes between Owner and Contractor shall be submitted to the Claims process set forth in this Article:
1. Appeals by Owner or Contractor of Engineer's decisions regarding Change Proposals;
 2. Owner demands for adjustments in the Contract Price or Contract Times, or other relief under the Contract Documents; and
 3. Disputes that Engineer has been unable to address because they do not involve the design (as set forth in the Drawings, Specifications, or otherwise), the acceptability of the Work, or other engineering or technical matters.
- B. *Submittal of Claim:* The party submitting a Claim shall deliver it directly to the other party to the Contract promptly (but in no event later than 30 days) after the start of the event giving rise thereto; in the case of appeals regarding Change Proposals within 30 days of the decision under appeal. The party submitting the Claim shall also furnish a copy to the Engineer, for its information only. The responsibility to substantiate a Claim shall rest with the party making the Claim. In the case of a Claim by Contractor seeking an increase in the Contract Times or Contract Price, or both, Contractor shall certify that the Claim is made in good faith, that the supporting data are accurate and complete, and that to the best of Contractor's knowledge and belief the amount of time or money requested accurately reflects the full amount to which Contractor is entitled.
- C. *Review and Resolution:* The party receiving a Claim shall review it thoroughly, giving full consideration to its merits. The two parties shall seek to resolve the Claim through the exchange of information and direct negotiations. The parties may extend the time for resolving the Claim by mutual agreement. All actions taken on a Claim shall be stated in writing and submitted to the other party, with a copy to Engineer.
- D. *Mediation:*
1. At any time after initiation of a Claim, Owner and Contractor may mutually agree to mediation of the underlying dispute. The agreement to mediate shall stay the Claim submittal and response process.

2. If Owner and Contractor agree to mediation, then after 60 days from such agreement, either Owner or Contractor may unilaterally terminate the mediation process, and the Claim submittal and decision process shall resume as of the date of the termination. If the mediation proceeds but is unsuccessful in resolving the dispute, the Claim submittal and decision process shall resume as of the date of the conclusion of the mediation, as determined by the mediator.
 3. Owner and Contractor shall each pay one-half of the mediator's fees and costs.
- E. *Partial Approval*: If the party receiving a Claim approves the Claim in part and denies it in part, such action shall be final and binding unless within 30 days of such action the other party invokes the procedure set forth in Article 17 for final resolution of disputes.
 - F. *Denial of Claim*: If efforts to resolve a Claim are not successful, the party receiving the Claim may deny it by giving written notice of denial to the other party. If the receiving party does not take action on the Claim within 90 days, then either Owner or Contractor may at any time thereafter submit a letter to the other party indicating that as a result of the inaction, the Claim is deemed denied, thereby commencing the time for appeal of the denial. A denial of the Claim shall be final and binding unless within 30 days of the denial the other party invokes the procedure set forth in Article 17 for the final resolution of disputes.
 - G. *Final and Binding Results*: If the parties reach a mutual agreement regarding a Claim, whether through approval of the Claim, direct negotiations, mediation, or otherwise; or if a Claim is approved in part and denied in part, or denied in full, and such actions become final and binding; then the results of the agreement or action on the Claim shall be incorporated in a Change Order to the extent they affect the Contract, including the Work, the Contract Times, or the Contract Price.

ARTICLE 13 – COST OF THE WORK; ALLOWANCES; UNIT PRICE WORK

13.01 Cost of the Work

- A. *Purposes for Determination of Cost of the Work*: The term Cost of the Work means the sum of all costs necessary for the proper performance of the Work at issue, as further defined below. The provisions of this Paragraph 13.01 are used for two distinct purposes:
 1. To determine Cost of the Work when Cost of the Work is a component of the Contract Price, under cost-plus-fee, time-and-materials, or other cost-based terms; or
 2. To determine the value of a Change Order, Change Proposal, Claim, set-off, or other adjustment in Contract Price. When the value of any such adjustment is determined on the basis of Cost of the Work, Contractor is entitled only to those additional or incremental costs required because of the change in the Work or because of the event giving rise to the adjustment.
- B. *Costs Included*: Except as otherwise may be agreed to in writing by Owner, costs included in the Cost of the Work shall be in amounts no higher than those prevailing in the locality of the Project, shall not include any of the costs itemized in Paragraph 13.01.C, and shall include only the following items:
 1. Payroll costs for employees in the direct employ of Contractor in the performance of the Work under schedules of job classifications agreed upon by Owner and Contractor. Such employees shall include, without limitation, superintendents, foremen, and other personnel employed full time on the Work. Payroll costs for employees not employed full time on the Work shall be apportioned on the basis of their time spent on the Work. Payroll costs shall include, but not be limited to, salaries and wages plus the cost of fringe benefits, which shall include social security contributions, unemployment, excise, and payroll taxes, workers' compensation, health and retirement benefits, bonuses, sick leave, and vacation and holiday pay applicable

thereto. The expenses of performing Work outside of regular working hours, on Saturday, Sunday, or legal holidays, shall be included in the above to the extent authorized by Owner.

2. Cost of all materials and equipment furnished and incorporated in the Work, including costs of transportation and storage thereof, and Suppliers' field services required in connection therewith. All cash discounts shall accrue to Contractor unless Owner deposits funds with Contractor with which to make payments, in which case the cash discounts shall accrue to Owner. All trade discounts, rebates, and refunds and returns from sale of surplus materials and equipment shall accrue to Owner, and Contractor shall make provisions so that they may be obtained.
3. Payments made by Contractor to Subcontractors for Work performed by Subcontractors. If required by Owner, Contractor shall obtain competitive bids from subcontractors acceptable to Owner and Contractor and shall deliver such bids to Owner, who will then determine, with the advice of Engineer, which bids, if any, will be acceptable. If any subcontract provides that the Subcontractor is to be paid on the basis of Cost of the Work plus a fee, the Subcontractor's Cost of the Work and fee shall be determined in the same manner as Contractor's Cost of the Work and fee as provided in this Paragraph 13.01.
4. Costs of special consultants (including but not limited to engineers, architects, testing laboratories, surveyors, attorneys, and accountants) employed for services specifically related to the Work.
5. Supplemental costs including the following:
 - a. The proportion of necessary transportation, travel, and subsistence expenses of Contractor's employees incurred in discharge of duties connected with the Work.
 - b. Cost, including transportation and maintenance, of all materials, supplies, equipment, machinery, appliances, office, and temporary facilities at the Site, and hand tools not owned by the workers, which are consumed in the performance of the Work, and cost, less market value, of such items used but not consumed which remain the property of Contractor.
 - c. Rentals of all construction equipment and machinery, and the parts thereof, whether rented from Contractor or others in accordance with rental agreements approved by Owner with the advice of Engineer, and the costs of transportation, loading, unloading, assembly, dismantling, and removal thereof. All such costs shall be in accordance with the terms of said rental agreements. The rental of any such equipment, machinery, or parts shall cease when the use thereof is no longer necessary for the Work.
 - d. Sales, consumer, use, and other similar taxes related to the Work, and for which Contractor is liable, as imposed by Laws and Regulations.
 - e. Deposits lost for causes other than negligence of Contractor, any Subcontractor, or anyone directly or indirectly employed by any of them or for whose acts any of them may be liable, and royalty payments and fees for permits and licenses.
 - f. Losses and damages (and related expenses) caused by damage to the Work, not compensated by insurance or otherwise, sustained by Contractor in connection with the performance of the Work (except losses and damages within the deductible amounts of property insurance established in accordance with Paragraph 6.05), provided such losses and damages have resulted from causes other than the negligence of Contractor, any Subcontractor, or anyone directly or indirectly employed by any of them or for whose acts any of them may be liable. Such losses shall include settlements made with the written

consent and approval of Owner. No such losses, damages, and expenses shall be included in the Cost of the Work for the purpose of determining Contractor's fee.

- g. The cost of utilities, fuel, and sanitary facilities at the Site.
- h. Minor expenses such as communication service at the Site, express and courier services, and similar petty cash items in connection with the Work.
- i. The costs of premiums for all bonds and insurance that Contractor is required by the Contract Documents to purchase and maintain.

C. *Costs Excluded:* The term Cost of the Work shall not include any of the following items:

- 1. Payroll costs and other compensation of Contractor's officers, executives, principals (of partnerships and sole proprietorships), general managers, safety managers, engineers, architects, estimators, attorneys, auditors, accountants, purchasing and contracting agents, expeditors, timekeepers, clerks, and other personnel employed by Contractor, whether at the Site or in Contractor's principal or branch office for general administration of the Work and not specifically included in the agreed upon schedule of job classifications referred to in Paragraph 13.01.B.1 or specifically covered by Paragraph 13.01.B.4. The payroll costs and other compensation excluded here are to be considered administrative costs covered by the Contractor's fee.
- 2. Expenses of Contractor's principal and branch offices other than Contractor's office at the Site.
- 3. Any part of Contractor's capital expenses, including interest on Contractor's capital employed for the Work and charges against Contractor for delinquent payments.
- 4. Costs due to the negligence of Contractor, any Subcontractor, or anyone directly or indirectly employed by any of them or for whose acts any of them may be liable, including but not limited to, the correction of defective Work, disposal of materials or equipment wrongly supplied, and making good any damage to property.
- 5. Other overhead or general expense costs of any kind and the costs of any item not specifically and expressly included in Paragraph 13.01.B.

D. *Contractor's Fee:* When the Work as a whole is performed on the basis of cost-plus, Contractor's fee shall be determined as set forth in the Agreement. When the value of any Work covered by a Change Order, Change Proposal, Claim, set-off, or other adjustment in Contract Price is determined on the basis of Cost of the Work, Contractor's fee shall be determined as set forth in Paragraph 11.04.C.

E. *Documentation:* Whenever the Cost of the Work for any purpose is to be determined pursuant to this Article 13, Contractor will establish and maintain records thereof in accordance with generally accepted accounting practices and submit in a form acceptable to Engineer an itemized cost breakdown together with supporting data.

13.02 Allowances

- A. It is understood that Contractor has included in the Contract Price all allowances so named in the Contract Documents and shall cause the Work so covered to be performed for such sums and by such persons or entities as may be acceptable to Owner and Engineer.
- B. *Cash Allowances:* Contractor agrees that:
 - 1. the cash allowances include the cost to Contractor (less any applicable trade discounts) of materials and equipment required by the allowances to be delivered at the Site, and all applicable taxes; and

2. Contractor's costs for unloading and handling on the Site, labor, installation, overhead, profit, and other expenses contemplated for the cash allowances have been included in the Contract Price and not in the allowances, and no demand for additional payment on account of any of the foregoing will be valid.
- C. *Contingency Allowance*: Contractor agrees that a contingency allowance, if any, is for the sole use of Owner to cover unanticipated costs.
- D. Prior to final payment, an appropriate Change Order will be issued as recommended by Engineer to reflect actual amounts due Contractor on account of Work covered by allowances, and the Contract Price shall be correspondingly adjusted.

13.03 *Unit Price Work*

- A. Where the Contract Documents provide that all or part of the Work is to be Unit Price Work, initially the Contract Price will be deemed to include for all Unit Price Work an amount equal to the sum of the unit price for each separately identified item of Unit Price Work times the estimated quantity of each item as indicated in the Agreement.
- B. The estimated quantities of items of Unit Price Work are not guaranteed and are solely for the purpose of comparison of Bids and determining an initial Contract Price. Payments to Contractor for Unit Price Work will be based on actual quantities.
- C. Each unit price will be deemed to include an amount considered by Contractor to be adequate to cover Contractor's overhead and profit for each separately identified item.
- D. Engineer will determine the actual quantities and classifications of Unit Price Work performed by Contractor. Engineer will review with Contractor the Engineer's preliminary determinations on such matters before rendering a written decision thereon (by recommendation of an Application for Payment or otherwise). Engineer's written decision thereon will be final and binding (except as modified by Engineer to reflect changed factual conditions or more accurate data) upon Owner and Contractor, subject to the provisions of the following paragraph.
- E. Within 30 days of Engineer's written decision under the preceding paragraph, Contractor may submit a Change Proposal, or Owner may file a Claim, seeking an adjustment in the Contract Price if:
 1. the quantity of any item of Unit Price Work performed by Contractor differs materially and significantly from the estimated quantity of such item indicated in the Agreement;
 2. there is no corresponding adjustment with respect to any other item of Work; and
 3. Contractor believes that it is entitled to an increase in Contract Price as a result of having incurred additional expense or Owner believes that Owner is entitled to a decrease in Contract Price, and the parties are unable to agree as to the amount of any such increase or decrease.

ARTICLE 14 – TESTS AND INSPECTIONS; CORRECTION, REMOVAL OR ACCEPTANCE OF DEFECTIVE WORK

14.01 *Access to Work*

- A. Owner, Engineer, their consultants and other representatives and personnel of Owner, independent testing laboratories, and authorities having jurisdiction will have access to the Site and the Work at reasonable times for their observation, inspection, and testing. Contractor shall provide them proper and safe conditions for such access and advise them of Contractor's safety procedures and programs so that they may comply therewith as applicable.

14.02 *Tests, Inspections, and Approvals*

- A. Contractor shall give Engineer timely notice of readiness of the Work (or specific parts thereof) for all required inspections and tests, and shall cooperate with inspection and testing personnel to facilitate required inspections and tests.
- B. Owner shall retain and pay for the services of an independent inspector, testing laboratory, or other qualified individual or entity to perform all inspections and tests expressly required by the Contract Documents to be furnished and paid for by Owner, except that costs incurred in connection with tests or inspections of covered Work shall be governed by the provisions of Paragraph 14.05.
- C. If Laws or Regulations of any public body having jurisdiction require any Work (or part thereof) specifically to be inspected, tested, or approved by an employee or other representative of such public body, Contractor shall assume full responsibility for arranging and obtaining such inspections, tests, or approvals, pay all costs in connection therewith, and furnish Engineer the required certificates of inspection or approval.
- D. Contractor shall be responsible for arranging, obtaining, and paying for all inspections and tests required:
 - 1. by the Contract Documents, unless the Contract Documents expressly allocate responsibility for a specific inspection or test to Owner;
 - 2. to attain Owner's and Engineer's acceptance of materials or equipment to be incorporated in the Work;
 - 3. by manufacturers of equipment furnished under the Contract Documents;
 - 4. for testing, adjusting, and balancing of mechanical, electrical, and other equipment to be incorporated into the Work; and
 - 5. for acceptance of materials, mix designs, or equipment submitted for approval prior to Contractor's purchase thereof for incorporation in the Work.

Such inspections and tests shall be performed by independent inspectors, testing laboratories, or other qualified individuals or entities acceptable to Owner and Engineer.

- E. If the Contract Documents require the Work (or part thereof) to be approved by Owner, Engineer, or another designated individual or entity, then Contractor shall assume full responsibility for arranging and obtaining such approvals.
- F. If any Work (or the work of others) that is to be inspected, tested, or approved is covered by Contractor without written concurrence of Engineer, Contractor shall, if requested by Engineer, uncover such Work for observation. Such uncovering shall be at Contractor's expense unless Contractor had given Engineer timely notice of Contractor's intention to cover the same and Engineer had not acted with reasonable promptness in response to such notice.

14.03 *Defective Work*

- A. *Contractor's Obligation:* It is Contractor's obligation to assure that the Work is not defective.
- B. *Engineer's Authority:* Engineer has the authority to determine whether Work is defective, and to reject defective Work.
- C. *Notice of Defects:* Prompt notice of all defective Work of which Owner or Engineer has actual knowledge will be given to Contractor.
- D. *Correction, or Removal and Replacement:* Promptly after receipt of written notice of defective Work, Contractor shall correct all such defective Work, whether or not fabricated, installed, or

completed, or, if Engineer has rejected the defective Work, remove it from the Project and replace it with Work that is not defective.

- E. *Preservation of Warranties*: When correcting defective Work, Contractor shall take no action that would void or otherwise impair Owner's special warranty and guarantee, if any, on said Work.
- F. *Costs and Damages*: In addition to its correction, removal, and replacement obligations with respect to defective Work, Contractor shall pay all claims, costs, losses, and damages arising out of or relating to defective Work, including but not limited to the cost of the inspection, testing, correction, removal, replacement, or reconstruction of such defective Work, fines levied against Owner by governmental authorities because the Work is defective, and the costs of repair or replacement of work of others resulting from defective Work. Prior to final payment, if Owner and Contractor are unable to agree as to the measure of such claims, costs, losses, and damages resulting from defective Work, then Owner may impose a reasonable set-off against payments due under Article 15.

14.04 *Acceptance of Defective Work*

- A. If, instead of requiring correction or removal and replacement of defective Work, Owner prefers to accept it, Owner may do so (subject, if such acceptance occurs prior to final payment, to Engineer's confirmation that such acceptance is in general accord with the design intent and applicable engineering principles, and will not endanger public safety). Contractor shall pay all claims, costs, losses, and damages attributable to Owner's evaluation of and determination to accept such defective Work (such costs to be approved by Engineer as to reasonableness), and for the diminished value of the Work to the extent not otherwise paid by Contractor. If any such acceptance occurs prior to final payment, the necessary revisions in the Contract Documents with respect to the Work shall be incorporated in a Change Order. If the parties are unable to agree as to the decrease in the Contract Price, reflecting the diminished value of Work so accepted, then Owner may impose a reasonable set-off against payments due under Article 15. If the acceptance of defective Work occurs after final payment, Contractor shall pay an appropriate amount to Owner.

14.05 *Uncovering Work*

- A. Engineer has the authority to require additional inspection or testing of the Work, whether or not the Work is fabricated, installed, or completed.
- B. If any Work is covered contrary to the written request of Engineer, then Contractor shall, if requested by Engineer, uncover such Work for Engineer's observation, and then replace the covering, all at Contractor's expense.
- C. If Engineer considers it necessary or advisable that covered Work be observed by Engineer or inspected or tested by others, then Contractor, at Engineer's request, shall uncover, expose, or otherwise make available for observation, inspection, or testing as Engineer may require, that portion of the Work in question, and provide all necessary labor, material, and equipment.
 - 1. If it is found that the uncovered Work is defective, Contractor shall be responsible for all claims, costs, losses, and damages arising out of or relating to such uncovering, exposure, observation, inspection, and testing, and of satisfactory replacement or reconstruction (including but not limited to all costs of repair or replacement of work of others); and pending Contractor's full discharge of this responsibility the Owner shall be entitled to impose a reasonable set-off against payments due under Article 15.
 - 2. If the uncovered Work is not found to be defective, Contractor shall be allowed an increase in the Contract Price or an extension of the Contract Times, or both, directly attributable to such uncovering, exposure, observation, inspection, testing, replacement, and reconstruction. If the

parties are unable to agree as to the amount or extent thereof, then Contractor may submit a Change Proposal within 30 days of the determination that the Work is not defective.

14.06 *Owner May Stop the Work*

- A. If the Work is defective, or Contractor fails to supply sufficient skilled workers or suitable materials or equipment, or fails to perform the Work in such a way that the completed Work will conform to the Contract Documents, then Owner may order Contractor to stop the Work, or any portion thereof, until the cause for such order has been eliminated; however, this right of Owner to stop the Work shall not give rise to any duty on the part of Owner to exercise this right for the benefit of Contractor, any Subcontractor, any Supplier, any other individual or entity, or any surety for, or employee or agent of any of them.

14.07 *Owner May Correct Defective Work*

- A. If Contractor fails within a reasonable time after written notice from Engineer to correct defective Work, or to remove and replace rejected Work as required by Engineer, or if Contractor fails to perform the Work in accordance with the Contract Documents, or if Contractor fails to comply with any other provision of the Contract Documents, then Owner may, after seven days written notice to Contractor, correct or remedy any such deficiency.
- B. In exercising the rights and remedies under this Paragraph 14.07, Owner shall proceed expeditiously. In connection with such corrective or remedial action, Owner may exclude Contractor from all or part of the Site, take possession of all or part of the Work and suspend Contractor's services related thereto, and incorporate in the Work all materials and equipment stored at the Site or for which Owner has paid Contractor but which are stored elsewhere. Contractor shall allow Owner, Owner's representatives, agents and employees, Owner's other contractors, and Engineer and Engineer's consultants access to the Site to enable Owner to exercise the rights and remedies under this paragraph.
- C. All claims, costs, losses, and damages incurred or sustained by Owner in exercising the rights and remedies under this Paragraph 14.07 will be charged against Contractor as set-offs against payments due under Article 15. Such claims, costs, losses and damages will include but not be limited to all costs of repair, or replacement of work of others destroyed or damaged by correction, removal, or replacement of Contractor's defective Work.
- D. Contractor shall not be allowed an extension of the Contract Times because of any delay in the performance of the Work attributable to the exercise by Owner of Owner's rights and remedies under this Paragraph 14.07.

ARTICLE 15 – PAYMENTS TO CONTRACTOR; SET-OFFS; COMPLETION; CORRECTION PERIOD

15.01 *Progress Payments*

- A. *Basis for Progress Payments:* The Schedule of Values established as provided in Article 2 will serve as the basis for progress payments and will be incorporated into a form of Application for Payment acceptable to Engineer. Progress payments on account of Unit Price Work will be based on the number of units completed during the pay period, as determined under the provisions of Paragraph 13.03. Progress payments for cost-based Work will be based on Cost of the Work completed by Contractor during the pay period.
- B. *Applications for Payments:*
 - 1. At least 20 days before the date established in the Agreement for each progress payment (but not more often than once a month), Contractor shall submit to Engineer for review an Application for Payment filled out and signed by Contractor covering the Work completed as of

the date of the Application and accompanied by such supporting documentation as is required by the Contract Documents. If payment is requested on the basis of materials and equipment not incorporated in the Work but delivered and suitably stored at the Site or at another location agreed to in writing, the Application for Payment shall also be accompanied by a bill of sale, invoice, or other documentation warranting that Owner has received the materials and equipment free and clear of all Liens, and evidence that the materials and equipment are covered by appropriate property insurance, a warehouse bond, or other arrangements to protect Owner's interest therein, all of which must be satisfactory to Owner.

2. Beginning with the second Application for Payment, each Application shall include an affidavit of Contractor stating that all previous progress payments received on account of the Work have been applied on account to discharge Contractor's legitimate obligations associated with prior Applications for Payment.
3. The amount of retainage with respect to progress payments will be as stipulated in the Agreement.

C. *Review of Applications:*

1. Engineer will, within 10 days after receipt of each Application for Payment, including each resubmittal, either indicate in writing a recommendation of payment and present the Application to Owner, or return the Application to Contractor indicating in writing Engineer's reasons for refusing to recommend payment. In the latter case, Contractor may make the necessary corrections and resubmit the Application.
2. Engineer's recommendation of any payment requested in an Application for Payment will constitute a representation by Engineer to Owner, based on Engineer's observations of the executed Work as an experienced and qualified design professional, and on Engineer's review of the Application for Payment and the accompanying data and schedules, that to the best of Engineer's knowledge, information and belief:
 - a. the Work has progressed to the point indicated;
 - b. the quality of the Work is generally in accordance with the Contract Documents (subject to an evaluation of the Work as a functioning whole prior to or upon Substantial Completion, the results of any subsequent tests called for in the Contract Documents, a final determination of quantities and classifications for Unit Price Work under Paragraph 13.03, and any other qualifications stated in the recommendation); and
 - c. the conditions precedent to Contractor's being entitled to such payment appear to have been fulfilled in so far as it is Engineer's responsibility to observe the Work.
3. By recommending any such payment Engineer will not thereby be deemed to have represented that:
 - a. inspections made to check the quality or the quantity of the Work as it has been performed have been exhaustive, extended to every aspect of the Work in progress, or involved detailed inspections of the Work beyond the responsibilities specifically assigned to Engineer in the Contract; or
 - b. there may not be other matters or issues between the parties that might entitle Contractor to be paid additionally by Owner or entitle Owner to withhold payment to Contractor.
4. Neither Engineer's review of Contractor's Work for the purposes of recommending payments nor Engineer's recommendation of any payment, including final payment, will impose responsibility on Engineer:

- a. to supervise, direct, or control the Work, or
 - b. for the means, methods, techniques, sequences, or procedures of construction, or the safety precautions and programs incident thereto, or
 - c. for Contractor's failure to comply with Laws and Regulations applicable to Contractor's performance of the Work, or
 - d. to make any examination to ascertain how or for what purposes Contractor has used the money paid on account of the Contract Price, or
 - e. to determine that title to any of the Work, materials, or equipment has passed to Owner free and clear of any Liens.
5. Engineer may refuse to recommend the whole or any part of any payment if, in Engineer's opinion, it would be incorrect to make the representations to Owner stated in Paragraph 15.01.C.2.
6. Engineer will recommend reductions in payment (set-offs) necessary in Engineer's opinion to protect Owner from loss because:
- a. the Work is defective, requiring correction or replacement;
 - b. the Contract Price has been reduced by Change Orders;
 - c. Owner has been required to correct defective Work in accordance with Paragraph 14.07, or has accepted defective Work pursuant to Paragraph 14.04;
 - d. Owner has been required to remove or remediate a Hazardous Environmental Condition for which Contractor is responsible; or
 - e. Engineer has actual knowledge of the occurrence of any of the events that would constitute a default by Contractor and therefore justify termination for cause under the Contract Documents.

D. Payment Becomes Due:

1. Ten days after presentation of the Application for Payment to Owner with Engineer's recommendation, the amount recommended (subject to any Owner set-offs) will become due, and when due will be paid by Owner to Contractor.

E. Reductions in Payment by Owner:

1. In addition to any reductions in payment (set-offs) recommended by Engineer, Owner is entitled to impose a set-off against payment based on any of the following:
- a. claims have been made against Owner on account of Contractor's conduct in the performance or furnishing of the Work, or Owner has incurred costs, losses, or damages on account of Contractor's conduct in the performance or furnishing of the Work, including but not limited to claims, costs, losses, or damages from workplace injuries, adjacent property damage, non-compliance with Laws and Regulations, and patent infringement;
 - b. Contractor has failed to take reasonable and customary measures to avoid damage, delay, disruption, and interference with other work at or adjacent to the Site;
 - c. Contractor has failed to provide and maintain required bonds or insurance;
 - d. Owner has been required to remove or remediate a Hazardous Environmental Condition for which Contractor is responsible;

- e. Owner has incurred extra charges or engineering costs related to submittal reviews, evaluations of proposed substitutes, tests and inspections, or return visits to manufacturing or assembly facilities;
 - f. the Work is defective, requiring correction or replacement;
 - g. Owner has been required to correct defective Work in accordance with Paragraph 14.07, or has accepted defective Work pursuant to Paragraph 14.04;
 - h. the Contract Price has been reduced by Change Orders;
 - i. an event that would constitute a default by Contractor and therefore justify a termination for cause has occurred;
 - j. liquidated damages have accrued as a result of Contractor's failure to achieve Milestones, Substantial Completion, or final completion of the Work;
 - k. Liens have been filed in connection with the Work, except where Contractor has delivered a specific bond satisfactory to Owner to secure the satisfaction and discharge of such Liens;
 - l. there are other items entitling Owner to a set off against the amount recommended.
2. If Owner imposes any set-off against payment, whether based on its own knowledge or on the written recommendations of Engineer, Owner will give Contractor immediate written notice (with a copy to Engineer) stating the reasons for such action and the specific amount of the reduction, and promptly pay Contractor any amount remaining after deduction of the amount so withheld. Owner shall promptly pay Contractor the amount so withheld, or any adjustment thereto agreed to by Owner and Contractor, if Contractor remedies the reasons for such action. The reduction imposed shall be binding on Contractor unless it duly submits a Change Proposal contesting the reduction.
 3. Upon a subsequent determination that Owner's refusal of payment was not justified, the amount wrongfully withheld shall be treated as an amount due as determined by Paragraph 15.01.C.1 and subject to interest as provided in the Agreement.

15.02 *Contractor's Warranty of Title*

- A. Contractor warrants and guarantees that title to all Work, materials, and equipment furnished under the Contract will pass to Owner free and clear of (1) all Liens and other title defects, and (2) all patent, licensing, copyright, or royalty obligations, no later than seven days after the time of payment by Owner.

15.03 *Substantial Completion*

- A. When Contractor considers the entire Work ready for its intended use Contractor shall notify Owner and Engineer in writing that the entire Work is substantially complete and request that Engineer issue a certificate of Substantial Completion. Contractor shall at the same time submit to Owner and Engineer an initial draft of punch list items to be completed or corrected before final payment.
- B. Promptly after Contractor's notification, Owner, Contractor, and Engineer shall make an inspection of the Work to determine the status of completion. If Engineer does not consider the Work substantially complete, Engineer will notify Contractor in writing giving the reasons therefor.
- C. If Engineer considers the Work substantially complete, Engineer will deliver to Owner a preliminary certificate of Substantial Completion which shall fix the date of Substantial Completion. Engineer shall attach to the certificate a punch list of items to be completed or corrected before final payment. Owner shall have seven days after receipt of the preliminary certificate during which to

make written objection to Engineer as to any provisions of the certificate or attached punch list. If, after considering the objections to the provisions of the preliminary certificate, Engineer concludes that the Work is not substantially complete, Engineer will, within 14 days after submission of the preliminary certificate to Owner, notify Contractor in writing that the Work is not substantially complete, stating the reasons therefor. If Owner does not object to the provisions of the certificate, or if despite consideration of Owner's objections Engineer concludes that the Work is substantially complete, then Engineer will, within said 14 days, execute and deliver to Owner and Contractor a final certificate of Substantial Completion (with a revised punch list of items to be completed or corrected) reflecting such changes from the preliminary certificate as Engineer believes justified after consideration of any objections from Owner.

- D. At the time of receipt of the preliminary certificate of Substantial Completion, Owner and Contractor will confer regarding Owner's use or occupancy of the Work following Substantial Completion, review the builder's risk insurance policy with respect to the end of the builder's risk coverage, and confirm the transition to coverage of the Work under a permanent property insurance policy held by Owner. Unless Owner and Contractor agree otherwise in writing, Owner shall bear responsibility for security, operation, protection of the Work, property insurance, maintenance, heat, and utilities upon Owner's use or occupancy of the Work.
- E. After Substantial Completion the Contractor shall promptly begin work on the punch list of items to be completed or corrected prior to final payment. In appropriate cases Contractor may submit monthly Applications for Payment for completed punch list items, following the progress payment procedures set forth above.
- F. Owner shall have the right to exclude Contractor from the Site after the date of Substantial Completion subject to allowing Contractor reasonable access to remove its property and complete or correct items on the punch list.

15.04 *Partial Use or Occupancy*

- A. Prior to Substantial Completion of all the Work, Owner may use or occupy any substantially completed part of the Work which has specifically been identified in the Contract Documents, or which Owner, Engineer, and Contractor agree constitutes a separately functioning and usable part of the Work that can be used by Owner for its intended purpose without significant interference with Contractor's performance of the remainder of the Work, subject to the following conditions:
 - 1. At any time Owner may request in writing that Contractor permit Owner to use or occupy any such part of the Work that Owner believes to be substantially complete. If and when Contractor agrees that such part of the Work is substantially complete, Contractor, Owner, and Engineer will follow the procedures of Paragraph 15.03.A through E for that part of the Work.
 - 2. At any time Contractor may notify Owner and Engineer in writing that Contractor considers any such part of the Work substantially complete and request Engineer to issue a certificate of Substantial Completion for that part of the Work.
 - 3. Within a reasonable time after either such request, Owner, Contractor, and Engineer shall make an inspection of that part of the Work to determine its status of completion. If Engineer does not consider that part of the Work to be substantially complete, Engineer will notify Owner and Contractor in writing giving the reasons therefor. If Engineer considers that part of the Work to be substantially complete, the provisions of Paragraph 15.03 will apply with respect to certification of Substantial Completion of that part of the Work and the division of responsibility in respect thereof and access thereto.
 - 4. No use or occupancy or separate operation of part of the Work may occur prior to compliance with the requirements of Paragraph 6.05 regarding builder's risk or other property insurance.

15.05 *Final Inspection*

- A. Upon written notice from Contractor that the entire Work or an agreed portion thereof is complete, Engineer will promptly make a final inspection with Owner and Contractor and will notify Contractor in writing of all particulars in which this inspection reveals that the Work, or agreed portion thereof, is incomplete or defective. Contractor shall immediately take such measures as are necessary to complete such Work or remedy such deficiencies.

15.06 *Final Payment*

A. *Application for Payment:*

1. After Contractor has, in the opinion of Engineer, satisfactorily completed all corrections identified during the final inspection and has delivered, in accordance with the Contract Documents, all maintenance and operating instructions, schedules, guarantees, bonds, certificates or other evidence of insurance, certificates of inspection, annotated record documents (as provided in Paragraph 7.11), and other documents, Contractor may make application for final payment.
2. The final Application for Payment shall be accompanied (except as previously delivered) by:
 - a. all documentation called for in the Contract Documents;
 - b. consent of the surety, if any, to final payment;
 - c. satisfactory evidence that all title issues have been resolved such that title to all Work, materials, and equipment has passed to Owner free and clear of any Liens or other title defects, or will so pass upon final payment.
 - d. a list of all disputes that Contractor believes are unsettled; and
 - e. complete and legally effective releases or waivers (satisfactory to Owner) of all Lien rights arising out of the Work, and of Liens filed in connection with the Work.
3. In lieu of the releases or waivers of Liens specified in Paragraph 15.06.A.2 and as approved by Owner, Contractor may furnish receipts or releases in full and an affidavit of Contractor that: (a) the releases and receipts include all labor, services, material, and equipment for which a Lien could be filed; and (b) all payrolls, material and equipment bills, and other indebtedness connected with the Work for which Owner might in any way be responsible, or which might in any way result in liens or other burdens on Owner's property, have been paid or otherwise satisfied. If any Subcontractor or Supplier fails to furnish such a release or receipt in full, Contractor may furnish a bond or other collateral satisfactory to Owner to indemnify Owner against any Lien, or Owner at its option may issue joint checks payable to Contractor and specified Subcontractors and Suppliers.

B. *Engineer's Review of Application and Acceptance:*

1. If, on the basis of Engineer's observation of the Work during construction and final inspection, and Engineer's review of the final Application for Payment and accompanying documentation as required by the Contract Documents, Engineer is satisfied that the Work has been completed and Contractor's other obligations under the Contract have been fulfilled, Engineer will, within ten days after receipt of the final Application for Payment, indicate in writing Engineer's recommendation of final payment and present the Application for Payment to Owner for payment. Such recommendation shall account for any set-offs against payment that are necessary in Engineer's opinion to protect Owner from loss for the reasons stated above with respect to progress payments. At the same time Engineer will also give written notice to Owner and Contractor that the Work is acceptable, subject to the provisions of Paragraph 15.07. Otherwise, Engineer will return the Application for Payment to Contractor, indicating in

writing the reasons for refusing to recommend final payment, in which case Contractor shall make the necessary corrections and resubmit the Application for Payment.

- C. *Completion of Work*: The Work is complete (subject to surviving obligations) when it is ready for final payment as established by the Engineer's written recommendation of final payment.
- D. *Payment Becomes Due*: Thirty days after the presentation to Owner of the final Application for Payment and accompanying documentation, the amount recommended by Engineer (less any further sum Owner is entitled to set off against Engineer's recommendation, including but not limited to set-offs for liquidated damages and set-offs allowed under the provisions above with respect to progress payments) will become due and shall be paid by Owner to Contractor.

15.07 *Waiver of Claims*

- A. The making of final payment will not constitute a waiver by Owner of claims or rights against Contractor. Owner expressly reserves claims and rights arising from unsettled Liens, from defective Work appearing after final inspection pursuant to Paragraph 15.05, from Contractor's failure to comply with the Contract Documents or the terms of any special guarantees specified therein, from outstanding Claims by Owner, or from Contractor's continuing obligations under the Contract Documents.
- B. The acceptance of final payment by Contractor will constitute a waiver by Contractor of all claims and rights against Owner other than those pending matters that have been duly submitted or appealed under the provisions of Article 17.

15.08 *Correction Period*

- A. If within one year after the date of Substantial Completion (or such longer period of time as may be prescribed by the terms of any applicable special guarantee required by the Contract Documents, or by any specific provision of the Contract Documents), any Work is found to be defective, or if the repair of any damages to the Site, adjacent areas that Contractor has arranged to use through construction easements or otherwise, and other adjacent areas used by Contractor as permitted by Laws and Regulations, is found to be defective, then Contractor shall promptly, without cost to Owner and in accordance with Owner's written instructions:
 - 1. correct the defective repairs to the Site or such other adjacent areas;
 - 2. correct such defective Work;
 - 3. if the defective Work has been rejected by Owner, remove it from the Project and replace it with Work that is not defective, and
 - 4. satisfactorily correct or repair or remove and replace any damage to other Work, to the work of others, or to other land or areas resulting therefrom.
- B. If Contractor does not promptly comply with the terms of Owner's written instructions, or in an emergency where delay would cause serious risk of loss or damage, Owner may have the defective Work corrected or repaired or may have the rejected Work removed and replaced. Contractor shall pay all claims, costs, losses, and damages (including but not limited to all fees and charges of engineers, architects, attorneys, and other professionals and all court or arbitration or other dispute resolution costs) arising out of or relating to such correction or repair or such removal and replacement (including but not limited to all costs of repair or replacement of work of others).
- C. In special circumstances where a particular item of equipment is placed in continuous service before Substantial Completion of all the Work, the correction period for that item may start to run from an earlier date if so provided in the Specifications.

- D. Where defective Work (and damage to other Work resulting therefrom) has been corrected or removed and replaced under this paragraph, the correction period hereunder with respect to such Work will be extended for an additional period of one year after such correction or removal and replacement has been satisfactorily completed.
- E. Contractor's obligations under this paragraph are in addition to all other obligations and warranties. The provisions of this paragraph shall not be construed as a substitute for, or a waiver of, the provisions of any applicable statute of limitation or repose.

ARTICLE 16 – SUSPENSION OF WORK AND TERMINATION

16.01 *Owner May Suspend Work*

- A. At any time and without cause, Owner may suspend the Work or any portion thereof for a period of not more than 90 consecutive days by written notice to Contractor and Engineer. Such notice will fix the date on which Work will be resumed. Contractor shall resume the Work on the date so fixed. Contractor shall be entitled to an adjustment in the Contract Price or an extension of the Contract Times, or both, directly attributable to any such suspension. Any Change Proposal seeking such adjustments shall be submitted no later than 30 days after the date fixed for resumption of Work.

16.02 *Owner May Terminate for Cause*

- A. The occurrence of any one or more of the following events will constitute a default by Contractor and justify termination for cause:
 - 1. Contractor's persistent failure to perform the Work in accordance with the Contract Documents (including, but not limited to, failure to supply sufficient skilled workers or suitable materials or equipment or failure to adhere to the Progress Schedule);
 - 2. Failure of Contractor to perform or otherwise to comply with a material term of the Contract Documents;
 - 3. Contractor's disregard of Laws or Regulations of any public body having jurisdiction; or
 - 4. Contractor's repeated disregard of the authority of Owner or Engineer.
- B. If one or more of the events identified in Paragraph 16.02.A occurs, then after giving Contractor (and any surety) ten days written notice that Owner is considering a declaration that Contractor is in default and termination of the contract, Owner may proceed to:
 - 1. declare Contractor to be in default, and give Contractor (and any surety) notice that the Contract is terminated; and
 - 2. enforce the rights available to Owner under any applicable performance bond.
- C. Subject to the terms and operation of any applicable performance bond, if Owner has terminated the Contract for cause, Owner may exclude Contractor from the Site, take possession of the Work, incorporate in the Work all materials and equipment stored at the Site or for which Owner has paid Contractor but which are stored elsewhere, and complete the Work as Owner may deem expedient.
- D. Owner may not proceed with termination of the Contract under Paragraph 16.02.B if Contractor within seven days of receipt of notice of intent to terminate begins to correct its failure to perform and proceeds diligently to cure such failure.
- E. If Owner proceeds as provided in Paragraph 16.02.B, Contractor shall not be entitled to receive any further payment until the Work is completed. If the unpaid balance of the Contract Price exceeds the cost to complete the Work, including all related claims, costs, losses, and damages (including but not limited to all fees and charges of engineers, architects, attorneys, and other professionals)

sustained by Owner, such excess will be paid to Contractor. If the cost to complete the Work including such related claims, costs, losses, and damages exceeds such unpaid balance, Contractor shall pay the difference to Owner. Such claims, costs, losses, and damages incurred by Owner will be reviewed by Engineer as to their reasonableness and, when so approved by Engineer, incorporated in a Change Order. When exercising any rights or remedies under this paragraph, Owner shall not be required to obtain the lowest price for the Work performed.

- F. Where Contractor's services have been so terminated by Owner, the termination will not affect any rights or remedies of Owner against Contractor then existing or which may thereafter accrue, or any rights or remedies of Owner against Contractor or any surety under any payment bond or performance bond. Any retention or payment of money due Contractor by Owner will not release Contractor from liability.
- G. If and to the extent that Contractor has provided a performance bond under the provisions of Paragraph 6.01.A, the provisions of that bond shall govern over any inconsistent provisions of Paragraphs 16.02.B and 16.02.D.

16.03 *Owner May Terminate For Convenience*

- A. Upon seven days written notice to Contractor and Engineer, Owner may, without cause and without prejudice to any other right or remedy of Owner, terminate the Contract. In such case, Contractor shall be paid for (without duplication of any items):
 - 1. completed and acceptable Work executed in accordance with the Contract Documents prior to the effective date of termination, including fair and reasonable sums for overhead and profit on such Work;
 - 2. expenses sustained prior to the effective date of termination in performing services and furnishing labor, materials, or equipment as required by the Contract Documents in connection with uncompleted Work, plus fair and reasonable sums for overhead and profit on such expenses; and
 - 3. other reasonable expenses directly attributable to termination, including costs incurred to prepare a termination for convenience cost proposal.
- B. Contractor shall not be paid on account of loss of anticipated overhead, profits, or revenue, or other economic loss arising out of or resulting from such termination.

16.04 *Contractor May Stop Work or Terminate*

- A. If, through no act or fault of Contractor, (1) the Work is suspended for more than 90 consecutive days by Owner or under an order of court or other public authority, or (2) Engineer fails to act on any Application for Payment within 30 days after it is submitted, or (3) Owner fails for 30 days to pay Contractor any sum finally determined to be due, then Contractor may, upon seven days written notice to Owner and Engineer, and provided Owner or Engineer do not remedy such suspension or failure within that time, terminate the contract and recover from Owner payment on the same terms as provided in Paragraph 16.03.
- B. In lieu of terminating the Contract and without prejudice to any other right or remedy, if Engineer has failed to act on an Application for Payment within 30 days after it is submitted, or Owner has failed for 30 days to pay Contractor any sum finally determined to be due, Contractor may, seven days after written notice to Owner and Engineer, stop the Work until payment is made of all such amounts due Contractor, including interest thereon. The provisions of this paragraph are not intended to preclude Contractor from submitting a Change Proposal for an adjustment in Contract Price or Contract Times or otherwise for expenses or damage directly attributable to Contractor's stopping the Work as permitted by this paragraph.

ARTICLE 17 – FINAL RESOLUTION OF DISPUTES

17.01 *Methods and Procedures*

- A. *Disputes Subject to Final Resolution:* The following disputed matters are subject to final resolution under the provisions of this Article:
 - 1. A timely appeal of an approval in part and denial in part of a Claim, or of a denial in full; and
 - 2. Disputes between Owner and Contractor concerning the Work or obligations under the Contract Documents, and arising after final payment has been made.
- B. *Final Resolution of Disputes:* For any dispute subject to resolution under this Article, Owner or Contractor may:
 - 1. elect in writing to invoke the dispute resolution process provided for in the Supplementary Conditions; or
 - 2. agree with the other party to submit the dispute to another dispute resolution process; or
 - 3. if no dispute resolution process is provided for in the Supplementary Conditions or mutually agreed to, give written notice to the other party of the intent to submit the dispute to a court of competent jurisdiction.

ARTICLE 18 – MISCELLANEOUS

18.01 *Giving Notice*

- A. Whenever any provision of the Contract Documents requires the giving of written notice, it will be deemed to have been validly given if:
 - 1. delivered in person, by a commercial courier service or otherwise, to the individual or to a member of the firm or to an officer of the corporation for which it is intended; or
 - 2. delivered at or sent by registered or certified mail, postage prepaid, to the last business address known to the sender of the notice.

18.02 *Computation of Times*

- A. When any period of time is referred to in the Contract by days, it will be computed to exclude the first and include the last day of such period. If the last day of any such period falls on a Saturday or Sunday or on a day made a legal holiday by the law of the applicable jurisdiction, such day will be omitted from the computation.

18.03 *Cumulative Remedies*

- A. The duties and obligations imposed by these General Conditions and the rights and remedies available hereunder to the parties hereto are in addition to, and are not to be construed in any way as a limitation of, any rights and remedies available to any or all of them which are otherwise imposed or available by Laws or Regulations, by special warranty or guarantee, or by other provisions of the Contract. The provisions of this paragraph will be as effective as if repeated specifically in the Contract Documents in connection with each particular duty, obligation, right, and remedy to which they apply.

18.04 *Limitation of Damages*

- A. With respect to any and all Change Proposals, Claims, disputes subject to final resolution, and other matters at issue, neither Owner nor Engineer, nor any of their officers, directors, members, partners, employees, agents, consultants, or subcontractors, shall be liable to Contractor for any

claims, costs, losses, or damages sustained by Contractor on or in connection with any other project or anticipated project.

18.05 *No Waiver*

- A. A party's non-enforcement of any provision shall not constitute a waiver of that provision, nor shall it affect the enforceability of that provision or of the remainder of this Contract.

18.06 *Survival of Obligations*

- A. All representations, indemnifications, warranties, and guarantees made in, required by, or given in accordance with the Contract, as well as all continuing obligations indicated in the Contract, will survive final payment, completion, and acceptance of the Work or termination or completion of the Contract or termination of the services of Contractor.

18.07 *Controlling Law*

- A. This Contract is to be governed by the law of the state in which the Project is located.

18.08 *Headings*

- A. Article and paragraph headings are inserted for convenience only and do not constitute parts of these General Conditions.

Supplementary Conditions

A. These Supplementary Conditions amend or supplement the Standard General Conditions of the Construction Contract, EJCDC® C-700 (2013 Edition). All provisions that are not so amended or supplemented remain in full force and effect.

B. The terms used in these Supplementary Conditions have the meanings stated in the General Conditions. Additional terms used in these Supplementary Conditions have the meanings stated below, which are applicable to both the singular and plural thereof.

C. The address system used in these Supplementary Conditions is the same as the address system used in the General Conditions, with the prefix "SC" added thereto.

D. Table of Contents

SC-1.01. Defined Terms	2
SC-2.01 Delivery of Bonds and Evidence of Insurance	3
SC-2.02 Copies of Documents.....	3
SC-2.03 Before Starting Construction	3
SC-2.05 Initial Acceptance of Schedules	3
SC-3.03 Reporting Discrepancies	3
SC-3.04 Requirements of the Contract Documents	4
SC-4.01 Commencement of Contract Times; Notice to Proceed.....	4
SC-4.03 Reference Points	4
SC-5.03 Subsurface and Physical Conditions	4
SC-5.05 Underground Facilities	4
SC-5.06 Hazardous Environmental Conditions	4
SC-6.01 Performance and Payment Bonds	5
SC-6.03 Contractor’s Insurance	5
SC-6.05 Property Insurance	7
SC-7.02.B Labor; Working Hours.....	8
SC-7.03.B Services, Materials and Equipment	8
SC-7.04 “Or Equals”	8
SC-7.05 Submittals	9
SC-7.06 Concerning Subcontractors, Suppliers, & Others	9
SC-7.08 Permits	9
SC-7.10 Laws and Regulations.....	9
SC-7.11 Record Documents	10
SC-7.13 Competent Person	10
SC-7.16 Shop Drawings	10
SC-7.17 Contractor's General Warranty and Guarantee	10
SC-7.18 Indemnification.....	10
SC-7.19 Delegation of Professional Design Services.....	11
SC-10.03 Project Representative.....	11
SC-10.10 American Iron & Steel	14
SC-11.01 Amending the Contract Documents; Changes in the Work	14
SC-11.02 Owner-Authorized Changes in the Work	14
SC-11.04 Change of Contract Price.....	14
SC-11.06 Change Proposals	15
SC-11.07 Execution of Change Orders.....	15
SC-11.08 Notification to Surety.....	15
SC-12.01.A Claims Process	15
SC-13.02 Allowances	16

SC-13.03 Unit Price Work.....	16
SC-14.02.A Tests and Inspections.....	16
SC-14.03 Defective Work	16
SC-15.01 Progress Payments	17
SC-15.02 Contractor's Warranty of Title.....	17
SC-15.04 Partial Utilization	17
SC-15.08.A Correction Period	18
SC-16.02 Owner May Terminate for Cause	18
SC-16.03 Owner May Terminate for Convenience.....	18
SC-18 Miscellaneous	18
SC-19 Federal Requirements (New)	19

SC-1.01 Defined Terms

SC 1.01.A.3 Add the following language at the end of last sentence of Paragraph 1.01.A.3:

The Application for Payment form to be used on this project is RD Form 1927-7.

SC 1.01.A.8 Insert a comma and the word “Engineer” immediately after the word “Contractor” in this definition.

SC 1.01.A.8 Add the following language at the end of last sentence of Paragraph 1.01.A.8:

The Change Order form to be used on this Project is EJCDC C-941. Agency approval is required before Change Orders are effective.

SC 1.01.A.48 Add the following language at the end of the last sentence of Paragraph 1.01.A.48:

A Work Change Directive cannot change Contract Price or Contract Times without a subsequent Change Order.

SC 1.01.A.49 Add the following new Paragraph after Paragraph 1.01.A.48:

Abnormal Weather Conditions – Conditions of extreme or unusual weather for a given region, elevation, or season as determined by Engineer. Extreme or unusual weather that is typical for a given region, elevation, or season should not be considered Abnormal Weather Conditions.

SC 1.01.A.50 Add the following new Paragraph after Paragraph 1.01.A.49:

Agency - The Project is financed in whole or in part by USDA Rural Utilities Service pursuant to the Consolidated Farm and Rural Development Act (7 USC Section 1921 et seq.). The Rural Utilities Service programs are administered through the USDA Rural Development offices; therefore, the Agency for these documents is USDA Rural Development.

SC 1.01.A.51 Add the following new Paragraph after Paragraph 1.01.A.50:

Manufacturer’s Certification letter is documentation provided by the manufacturer, supplier, distributor, vendor, fabricator, etc. to various entities stating that the American Iron and Steel products to be used in the project are produced in the United States in accordance with American Iron and Steel requirements. Refer to Manufacturer’s Certification Letter provided in these Contract Documents.

SC 1.01.A.52 Add the following new Paragraph after Paragraph 1.01.A.51:

AIS - refers to requirements mandated by Section 746 of Title VII of the Consolidated Appropriations Act of 2017 (Division A - Agriculture, Rural Development, Food and Drug Administration, and Related Agencies Appropriations Act, 2017) and subsequent statutes mandating domestic preference. The term “iron and steel products” means the following products made primarily of iron or steel: lined or unlined pipes and fittings, manhole covers and

other municipal castings, hydrants, tanks, flanges, pipe clamps and restraints, valves, structural steel, reinforced precast concrete, and construction materials.

SC-2.01 Delivery of Bonds and Evidence of Insurance

Delete Paragraphs 2.01 B. and C. in their entirety and insert the following in their place:

B. Evidence of Contractor's Insurance: When Contractor delivers the executed counterparts of the Agreement to Owner, Contractor shall also deliver to Owner copies of the policies of insurance (including all endorsements, and identification of applicable self-insured retentions and deductibles) required to be provided by Contractor in Article 6. Contractor may block out (redact) any confidential premium or pricing information contained in any policy or endorsement furnished under this provision.

SC-2.02 Copies of Documents

Amend the first sentence of Paragraph 2.02.A. to read as follows:

Owner shall furnish the Contractor up to five copies of the Contract Documents (including one fully executed counterpart of the Agreement), and one copy in electronic portable document format (PDF).

SC-2.03 Before Starting Construction

Add the following subparagraph to Paragraph 2.03:

4. a proposed listing of subcontractors and major material and equipment suppliers. The list shall include any proposed substitutions in accordance with Paragraph 7.05.

SC-2.05 Initial Acceptance of Schedules

Add the following language to the end of Paragraph 2.05.A.2:

The schedule for shop drawings shall show all submittals complete before 25% of completion of the Work and the schedule for maintenance manuals shall show all submittals complete before 50% of completion of the Work.

Add the following language to the end of Paragraph 2.05.A.3:

The Bid will be considered the Schedule of Values of the Work required by the General Conditions.

SC-3.03 Reporting Discrepancies

Add the following language at the end of Paragraph 3.03.A:

4. Contractor shall report apparent discrepancies to Engineer using a Request for Information form on a form supplied by Engineer. The Request for Information form shall:

- a. be submitted by Contractor only;
- b. be legible and complete;
- c. not be used for the purposes of only confirming or verifying issues; and,
- d. be prioritized by Contractor in the event that multiple Requests for Information are outstanding.

Requests for Information that are not in conformance with the requirements above shall be returned to Contractor without response.

5. Contractor shall not be relieved of its responsibility to coordinate the Work to prevent adverse impacts to Contractor's Project Schedule while submitting Requests for Information.

6. If Contractor believes the Scope of Work included in the Request for Information has a cost and/or time impact, Contractor should submit a claim in accordance with Article 12 of these General Conditions.

7. If Contractor proceeds with work when Contractor had actual knowledge or should have known that a conflict, error, ambiguity, or discrepancy existed as indicated above, correction of work constructed without such notification to Engineer shall be at Contractor's expense, (except in an emergency as authorized by Paragraph 7.15.A).

SC-3.04 Requirements of the Contract Documents

Delete Paragraph 3.04.C in its entirety.

SC-4.01 Commencement of Contract Times; Notice to Proceed

SC 4.01.A Amend the last sentence of Paragraph 4.01.A by striking out the following words: In no event will the Contract Times commence to run later than the ninetieth day after the day of Bid opening or the thirtieth day after the Effective Date of the Contract, whichever date is earlier.

SC-4.03 Reference Points

Add the following new paragraph immediately after Paragraph 4.03.A:

B. CONTRACTOR is referred to the General Requirements for additional requirements for laying out the work.

SC-5.03 Subsurface and Physical Conditions

Delete Paragraphs 5.03.A and 5.03.B in their entirety and insert the following:

A. No reports of explorations or tests of subsurface conditions at or adjacent to the Site, or drawings of physical conditions relating to existing surface or subsurface structures at the Site, are known to Owner.

SC-5.05 Underground Facilities

Add the following paragraph immediately after Paragraph 5.05.E:

F. Contractor is referred to the General Requirements for requirements for keeping records of Underground Facilities and allowing facility owners to inspect.

SC-5.06 Hazardous Environmental Conditions

Delete Paragraphs 5.06.A and 5.06.B in their entirety and insert the following:

A. No reports or drawings related to Hazardous Environmental Conditions at the Site are known to Owner.

B. Not Used.

SC-6.01 Performance and Payment Bonds

Add the following new paragraphs immediately after Paragraph 6.01.F:

G. The forms of the performance and payment Bonds attached hereto shall be used for the Contract. Note instructions thereon as to the form applicable. Each form contemplates one corporate surety only. In case co-sureties or individual sureties will be furnished, proper forms therefore shall be obtained. Besides the stipulations of Paragraphs 6.01 through 6.03, the surety on the Bonds shall provide a certificate indicating surety is licensed to underwrite contracts in the jurisdiction of the project location which shall be attached to the Bonds.

H. Every Bond must run to Owner.

I. If the principal is an individual, his/her full name and residence shall be inserted in the body thereof, and he/she shall sign the Bonds with his/her usual signature on the line opposite the scroll seal. If the principals are partners, their individual names shall appear in the body of the Bonds, with the recital that they are partners comprising a firm, naming it, and all the members of the firm shall execute the Bonds as individuals.

J. The signature of a witness shall appear in the appropriate places, attesting the signatures of each individual party to the Bonds.

K. If the principal is a corporation, the name of the state in which incorporated shall be inserted in the appropriate place in the body of the Bonds, and said instrument shall be executed and attested under the corporate seal as indicated on the form. If the corporation has no seal, the fact shall be stated, in which case a scroll or adhesive seal shall appear following the corporate name. This also applies to execution by surety.

L. The date of the Bonds must not be prior to the date of the Contract for which given.

M. The bond shall be signed by an individual authorized to sign on behalf of the surety and a power of attorney, authorizing the execution of the Bonds by an attorney-in-fact, or agent of the surety, shall be attached to one executed counterpart of the Bonds.

SC-6.03 Contractor's Insurance

Add the following to the end of Paragraph 6.03.C.7:

All additional insureds shall be endorsed on the policy as required in Paragraph 6.03.C.7. Endorsements shall not exclude supervisory or inspection services.

Delete Paragraph 6.03.C.8 in its entirety and add the following new paragraphs immediately after Paragraph 6.03.C.7:

8. Railroad Protective Liability Policy: Not applicable.

a. CONTRACTOR shall provide a Railroad Protective Liability Policy for bodily injury, property damage liability, and physical damage to property liability, per limits, duration, and conditions noted in the documents provided by the Railroad bound at the end of Division 1.

9. The types of insurance and the limits of liability indicated are the minimum required. Neither Owner nor Engineer warrant the adequacy of the types of insurance or the limits of liability required. Any policy exclusions shall be indicated on the insurance certificate. Contractor shall provide verification of all coverages with or on the insurance certificate.

10. Regardless whether or not an Owners' and Contractors' Protective (OCP) policy or Project Management Protective Liability (PMPL) policy is furnished, insurance certificates for commercial general, automobile, umbrella, and builders risk shall specifically indicate by name the additional insureds which are to include Owner and Engineer as well as other persons or entities so identified. Certificates shall be Acord 25-S or equivalent.

11. As an alternative to providing Form CG 20 10 10 01 or CG 20 10 07 04, Contractor may furnish to Owner an OCP policy or a PMPL policy with Owner as the named insured and Engineer as either an additional insured or a named insured. OCP policy or PMPL policy shall provide for bodily injury and property damage coverage equal to the sum of: the general aggregate limit for commercial general liability plus the amount specified for the umbrella coverage. OCP policy or PMPL policy shall provide coverage arising out of:

- a. operations performed by Contractor at the project location.
- b. acts or omissions in connection with the general supervision, inspection and/or coordination of such operations.

If an OCP or PMPL policy is provided, Contractor shall provide originals of the Final OCP or PMPL to all insured and additional insured parties.

12. Endorsements, OCP policy, PMPL policy, or General Liability policy shall not exclude supervisory or inspection services.

13. Contractor shall also provide an Additional Insured Endorsement for the automobile policy. Endorsement form shall be CA 20 48, or equal.

Change in Paragraph 6.03.I.3 the phrase "materially changed" to read "materially changed with respect to coverage on the project."

Delete Paragraph 6.03.J in its entirety and insert the following new paragraph in its place:

J. The stated limits of Paragraphs 6.03.K.1, 6.03.K.2, and 6.03.K.3 can be obtained through individual policies or in conjunction with an umbrella policy (pay on behalf form) to arrive at the total limits requested.

Add the following new paragraph immediately after Paragraph 6.03.J:

K. The limits of liability for the insurance required by Paragraph 6.03 of the General Conditions shall provide coverage for not less than the following amounts or greater where required by Laws and Regulations:

- 1. Workers' Compensation, and related coverages under Paragraphs 6.03.A.1 and A.2 of the General Conditions:

State: Statutory

Federal, if applicable (e.g., Longshoreman's): Statutory

Foreign voluntary worker compensation Statutory

- 2. Contractor's Commercial General Liability under Paragraphs 6.03.B and 6.03.C of the General Conditions:

General Aggregate \$ 2,000,000

Products - Completed Operations Aggregate	\$ <u>2,000,000</u>
Personal and Advertising Injury	\$ <u>1,000,000</u>
Each Occurrence (Bodily Injury and Property Damage)	\$ <u>1,000,000</u>

General Aggregate Limits specified above shall apply separately to this project by attachment of:

“Amendment of Limits of Insurance–Designated Location(s) General Aggregate Limit Endorsement (ISO Form No. CG 25040509) or “Designated Construction Project(s) General Aggregate Limit” Endorsement (ISO Form CG 25030509) or equivalent endorsement coverage.

3. Automobile Liability under Paragraph 6.03.D. of the General Conditions:

Combined Single Limit of	\$ <u>1,000,000</u>
--------------------------	---------------------

4. Excess or Umbrella Liability:

Per Occurrence	\$ <u>1,000,000</u>
General Aggregate	\$ <u>1,000,000</u>

5. Contractor’s Pollution Liability:

Each Occurrence	\$ _____
General Aggregate	\$ _____

If box is checked, Contractor is not required to provide Contractor’s Pollution Liability insurance under this Contract

6. Additional Insureds: In addition to Owner and Engineer, include as additional insureds the following: none.

SC-6.05 Property Insurance

Delete from the first sentence of Paragraph 6.05.A.2, the phrase “All-risk” policy form and insert the following in its place:

“Cause of Loss-Special Form”

Delete from the first sentence of Paragraph 6.05.A.2, the phrase “(other than caused by flood)” and insert the following in its place:

“(including that caused by flood and hydrostatic pressure)”

Delete Paragraph 6.05.A.10 and insert the following in its place:

10. Not used.

Delete Paragraph 6.05.A.12 and insert the following in its place:

12. Not used.

Add the following to the list of items in Paragraph 6.05.A, as numbered items:

14. include for the benefit of Owner loss of profits and soft cost coverage including, without limitation, fixed expenses and debt service for a minimum of 12 months with a maximum deductible of 30 days, plus attorneys fees and engineering or other consultants' fees, if not otherwise covered;

SC-7.02.B Labor; Working Hours

Amend the first and second sentences of Paragraph 7.02.B to state "...all Work at the Site shall be performed during regular daylight working hours, 7:00 am through 5:00 pm. Contractor will not perform Work on a Saturday, Sunday or any legal holiday unless approved by the Engineer."

SC-7.03 Services, Materials and Equipment

Add the following to the end of Paragraph 7.03.B:

Suppliers shall be deemed to impliedly warrant that their products and all component materials incorporated into them are suitable and fit for the intended use of such products and shall be free from defect in material, workmanship or design, such warranty to run to the benefit of Owner and Engineer. The foregoing applies whether the products or their component materials are specified in the Contract Documents or are of Supplier's design.

Add the following new Paragraph 7.03.D:

All iron and steel products must meet American Iron and Steel requirements.

SC-7.04 "Or Equals"

SC 7.04.A Amend the third sentence of Paragraph 7.04.A by striking out the following words:

Unless the specification or description contains or is followed by words reading that no like, equivalent, or 'or-equal' item is permitted.

SC 7.04.A.1 Amend the last sentence of Paragraph a.3 by striking out "and;" and adding a period at the end of Paragraph a.3.

SC 7.04.A.1 Delete paragraph 7.04.A.1.a.4 in its entirety and insert "Deleted" in its place.

SC 7.04.B.1 Add paragraph 7.04.B.1.in its entirety:

Contractor shall include a Manufacturer's Certification letter for compliance with American Iron and Steel requirements in support data, if applicable. In addition, Contractor shall maintain an updated AIS Materials List to ensure that for de minimis waiver, cost is less than 5% of total materials cost for project and for minor components waiver, the cost of the non-domestically produced component is less than 5% of the total materials cost of the project. An excel version that will compute all totals can be obtained from the RD state office that can be used as working copy.

SC-7.05 Substitutes

SC 7.05.A.3.a.4 Add paragraph 7.05.A.3.a.4 in its entirety:

- 4) comply with American Iron and Steel by providing Manufacturer's Certification letter of American Iron and Steel compliance, if applicable. Refer to Manufacturer's Certification Letter provided in these Contract Documents.

SC-7.06 Concerning Subcontractors, Suppliers, and Others

SC 7.06.A Amend Paragraph 7.06.A by adding the following text to the end of the Paragraph:

The Contractor shall not award work valued at more than fifty percent of the Contract Price to Subcontractor(s), without prior written approval of the Owner.

SC 7.06.B Delete paragraph 7.06.B in its entirety and insert "Deleted" in its place.

SC 7.06.E Amend the second sentence of Paragraph 7.06.E by striking out "Owner may also require Contractor to retain specific replacements; provided, however, that".

SC-7.08 Permits

Delete last sentence of Paragraph 7.08.A and add the following in its place:

See General Requirements and technical specification sections for utility charge provisions.

Add Paragraph 7.08.B as follows:

- B. See General Requirements for additional permit information.

SC-7.10 Laws and Regulations

Add Paragraph 7.10.D as follows:

- D. Contractor shall comply with the following Kentucky Bidding & Wage Requirements:

Kickback Statutes—Contractor shall comply with the requirements of KRS 45A.455 with respect to gratuities and kickbacks among other matters.

Campaign Finance Disclosure—Contractor shall comply with requirements of KRS 45A.395 with respect to campaign finance laws.

Labor Law Disclosures—Contractor shall comply with requirements of KRS 45A.343 with respect to labor law disclosure.

Payment Bond for Wages Due—Contractor, whether a corporation, partnership, or individual, who have not been doing business in the State of Kentucky for five consecutive years, shall comply with KRS 337.200 which requires a Performance Bond to assure payment of wages.

SC-7.11 Record Documents

Replace Paragraph 7.11.A with the following:

Contractor shall maintain in a safe place at the Site one printed record copy of all Drawings, Specifications, Addenda, Change Orders, Work Change Directives, Field Orders, written interpretations and clarifications, and approved Shop Drawings. Manufacturers' Certification letter is documentation provided by the manufacturer, supplier, distributor, vendor, fabricator, etc. to various entities stating that the iron and steel products to be used in the project are produced in the United States in accordance with American Iron and Steel Requirements. Refer to Manufacturer's Certification Letter provided in these Contract Documents. Contractor shall keep such record documents in good order and annotate them to show changes made during construction. These record documents, together with all approved Samples, will be available to Engineer for reference. Upon completion of the Work, Contractor shall deliver these record documents to Engineer. Upon completion of the Work, these record documents, samples, and shop drawings shall be delivered by Contractor to Owner.

SC-7.13 Competent Person

Add the following new paragraph immediately after Paragraph 7.13.A:

B. Contractor shall keep at the Site at all times during the progress of the Work a competent person to comply with OSHA trenching and excavation requirements. The competent person shall be one who is capable of identifying existing and predictable hazards in the surroundings, or working conditions that are unsanitary, hazardous or dangerous to employees, and who has authorization to take prompt corrective measures to eliminate them.

SC-7.16 Shop Drawings

Add Paragraph 7.16.A.1.e:

- e. obtain the Manufacturer's Certification letter for any item in the submittal subject to American Iron and Steel requirements and include the Certificate in the submittal. Refer to Manufacturer's Certification Letter provided in these Contract Documents.

Add Paragraph 7.16.D.9

- 9. Engineer's review and approval of Shop Drawing or Sample shall include review of compliance with American Iron and Steel requirements, as applicable.

Add the following new paragraphs immediately after Paragraph 7.16.E:

F. Contractor shall furnish required submittals with sufficient information and accuracy in order to obtain required approval of an item with no more than three submittals. Engineer will record Engineer's time for reviewing subsequent submittals of Shop Drawings, samples or other items requiring approval and Contractor shall reimburse Owner for Engineer's charges for such time.

G. In the event that Contractor requests a substitution for a previously approved item, Contractor shall reimburse Owner for Engineer's charges for its review time unless the need for such change is beyond the control of Contractor.

SC-7.17 Contractor's General Warranty and Guarantee

Add Paragraph 7.17.E:

E. Contractor shall certify upon Substantial Completion that all Work and Materials has complied with American Iron and Steel requirements as mandated and subsequent statutes mandating

domestic preference. Contractor shall provide Contractor's Certification Letter to Owner. Refer to General Contractor's Certification Letter provided in these Contract Documents.

SC-7.18 Indemnification

Add the following to the end of Paragraph 7.18.A:

In addition, Contractor shall indemnify, hold harmless, and pay for the defense of Owner and Engineer from and against claims, losses, or damages in regard to any act or failure to act by Owner or Engineer in connection with general supervision, inspection and/or coordination of Contractor's operations.

Contractor shall, at its own expense, appear, defend, and pay all fees of attorneys and all costs and other expenses arising therefrom or incurred in connection therewith; and, if any judgments shall be rendered against any individual or entity indemnified hereunder in any such action, Contractor shall, at its own expense, satisfy and discharge same. Contractor expressly understands and agrees that any Letter of Credit or insurance protection required by the Contract, or otherwise provided by Contractor, shall in no way limit the responsibility to indemnify, keep and, save harmless, and defend any individual or entity indemnified hereunder as herein provided.

Delete Paragraph 7.18.C.1 and 7.18.C.2. Insert new Paragraphs 7.18.C.1 and D:

1. the preparation of Drawings, Specifications, or Property Surveys.

D. For any matter for which Owner and Engineer are indemnified under Paragraph 7.18.A, Contractor shall pay for Owner's and Engineer's reasonable defense, including, but not limited to, all fees and charges of engineers, architects, attorneys, and other professionals and all court or arbitration or other dispute resolution costs or awards until Owner or Engineer are found negligent. If Owner or Engineer are found negligent, Owner or Engineer shall reimburse Contractor for the prorata extent of Owner's or Engineer's negligence for the cost of Owner's or Engineer's reasonable defense.

SC-7.19 Delegation of Professional Design Services

Add the following new paragraphs immediately after Paragraph 7.19.E:

F. The design professional providing the design calculations and design drawings shall be licensed in the State of the Project.

G. The design calculation and design drawings are not shop drawings, but shall be submitted to ENGINEER separately along with the required shop drawings for the system, material, or equipment specified. These calculations will be forwarded to OWNER for their records.

SC-10.03 Project Representative

Add the following new paragraphs immediately after Paragraph 10.03.A:

B. The Resident Project Representative (RPR) will be Engineer's representative at the Site, will act as directed by and under the supervision of Engineer, and will confer with Engineer regarding RPR's actions.

1. General: RPR's dealings in matters pertaining to the Work in general shall be with Engineer and Contractor. RPR's dealings with Subcontractors shall only be through or with the full knowledge and approval of Contractor. RPR shall generally communicate with Owner only with the knowledge of and under the direction of Engineer.

2. Schedules: Review the progress schedule, schedule of Shop Drawing and Sample submittals, and Schedule of Values prepared by Contractor and consult with Engineer concerning acceptability.

3. Conferences and Meetings: Attend meetings with Contractor, such as preconstruction conferences, progress meetings, job conferences, and other Project-related meetings, and prepare and circulate copies of minutes thereof.

4. Liaison:

a. Serve as Engineer's liaison with Contractor. Working principally through Contractor's authorized representative or designee, assist in providing information regarding the provisions and intent of the Contract Documents.

b. Assist Engineer in serving as Owner's liaison with Contractor when Contractor's operations affect Owner's on-Site operations.

c. Assist in obtaining from Owner additional details or information, when required for proper execution of the Work.

5. Interpretation of Contract Documents: Report to Engineer when clarifications and interpretations of the Contract Documents are needed and transmit to Contractor clarifications and interpretations as issued by Engineer.

6. Shop Drawings and Samples:

a. Record date of receipt of Samples and Contractor-approved Shop Drawings.

b. Receive Samples which are furnished at the Site by Contractor, and notify Engineer of availability of Samples for examination.

c. Advise Engineer and Contractor of the commencement of any portion of the Work requiring a Shop Drawing or Sample submittal for which RPR believes that the submittal has not been approved by Engineer.

7. Modifications: Consider and evaluate Contractor's suggestions for modifications in Drawings or Specifications and report such suggestions, together with RPR's recommendations, if any, to Engineer. Transmit to Contractor in writing decisions as issued by Engineer.

8. Review of Work and Rejection of Defective Work:

a. Conduct on-Site observations of Contractor's work in progress to assist Engineer in determining if the Work is in general proceeding in accordance with the Contract Documents.

b. Report to Engineer whenever RPR believes that any part of Contractor's work in progress is defective, will not produce a completed Project that conforms generally to the Contract Documents, or will imperil the integrity of the design concept of the completed Project as a functioning whole as indicated in the Contract Documents, or has been damaged, or does not meet the requirements of any inspection, test or approval required to be made; and advise Engineer of that part of work in progress that RPR believes should be corrected or rejected or should be uncovered for observation, or requires special testing, inspection or approval.

9. Inspections, Tests, and System Start-ups:

a. Verify that tests, equipment, and systems start-ups and operating and maintenance training are conducted in the presence of appropriate Owner's personnel, and that Contractor maintains adequate records thereof.

b. Observe, record, and report to Engineer appropriate details relative to the test procedures and systems start-ups.

10. Records:

a. Prepare a daily report or keep a diary or log book, recording Contractor's hours on the Site, Subcontractors present at the Site, weather conditions, data relative to questions of Change Orders, Field Orders, Work Change Directives, or changed conditions, Site visitors, deliveries of equipment or materials, daily activities, decisions, observations in general, and specific observations in more detail as in the case of observing test procedures; and send copies to Engineer.

b. Record names, addresses, fax numbers, e-mail addresses, web site locations, and telephone numbers of all Contractors, Subcontractors, and major Suppliers of materials and equipment.

c. Maintain records for use in preparing Project documentation.

11. Reports:

a. Furnish to Engineer periodic reports as required of progress of the Work and of Contractor's compliance with the Progress Schedule and schedule of Shop Drawing and Sample submittals.

b. Draft and recommend to Engineer proposed Change Orders, Work Change Directives, and Field Orders. Obtain backup material from Contractor.

c. Immediately notify Engineer of the occurrence of any Site accidents, emergencies, acts of God endangering the Work, force majeure or delay events, damage to property by fire or other causes, or the discovery of any Constituent of Concern or Hazardous Environmental Condition.

12. Payment Requests: Review applications for payment with Contractor for compliance with the established procedure for their submission and forward with recommendations to Engineer, noting particularly the relationship of the payment requested to the Schedule of Values, Work completed, and materials and equipment delivered at the Site but not incorporated in the Work.

13. Certificates, Operation and Maintenance Manuals: During the course of the Work, verify that materials and equipment certificates, operation and maintenance manuals and other data required by the Contract Documents to be assembled and furnished by Contractor are applicable to the items actually installed and in accordance with the Contract Documents, and have these documents delivered to Engineer for review and forwarding to Owner prior to payment for that part of the Work.

14. Completion:

a. Participate in Engineer's visits to the Site to determine Substantial Completion, assist in the determination of Substantial Completion and the preparation of a punch list of items to be completed or corrected.

b. Participate in Engineer's final visit to the Site to determine completion of the Work, in the company of Owner and Contractor, and prepare a final punch list of items to be completed and deficiencies to be remedied.

c. Observe whether all items on the final list have been completed or corrected and make recommendations to Engineer concerning acceptance and issuance of the notice of acceptability of the work.

C. The RPR shall not:

1. Authorize any deviation from the Contract Documents or substitution of materials or equipment (including “or-equal” items).
2. Exceed limitations of Engineer’s authority as set forth in the Contract Documents.
3. Undertake any of the responsibilities of Contractor, Subcontractors, or Suppliers.
4. Advise on, issue directions relative to, or assume control over any aspect of the means, methods, techniques, sequences or procedures of Contractor’s work.
5. Advise on, issue directions regarding, or assume control over security or safety practices, precautions, and programs in connection with the activities or operations of Owner or Contractor.
6. Participate in specialized field or laboratory tests or inspections conducted off-site by others except as specifically authorized by Engineer.
7. Accept Shop Drawing or Sample submittals from anyone other than Contractor.
8. Authorize Owner to occupy the Project in whole or in part.

SC-10.10. American Iron & Steel

Add Paragraph 10.10.A

A. Services required to determine and certify that to the best of the Engineer’s knowledge and belief all iron and steel products referenced in engineering analysis, the Plans, Specifications, Bidding Documents, and associated Bid Addenda requiring design revisions are either produced in the United States or are the subject of an approved waiver and services required to determine to the best of the engineer’s knowledge and belief that approved substitutes, equals, and all iron and steel products proposed in the shop drawings, Change Orders and Partial Payment Estimates are either produced in the United States or are the subject of an approved waiver under the Consolidated Appropriations Act of 2017.

SC-11.01 Amending the Contract Documents; Changes in the Work

Delete Paragraph 11.01.A.1.b in its entirety.

SC-11.02 Owner-Authorized Changes in the Work

Amend the second sentence in Paragraph 11.02.A to read as follows: Such changes shall be supported by ENGINEER’s recommendation.

SC-11.04 Change of Contract Price

Add the following sentence at the end of paragraph 11.04.B.2:

Any overhead and profit allowance for lump sum work shall be in accordance with paragraph 11.04.C.2. unless OWNER and CONTRACTOR agree that these allowances are not appropriate for the Work involved.

SC-11.06. Change Proposals

Modify Paragraph 11.06.A.1

Inserting the following sentence after “within 15 days after the submittal of the Change Proposal.”: “Include supporting data (name of manufacturer, city and state where the product was manufactured, description of product, signature of authorized manufacturer’s representative) in the Manufacturer’s Certification Letter, as applicable.”

Delete Paragraph 11.06.B in its entirety.

SC-11.07 Execution of Change Orders

Delete Paragraphs 11.07.A and 11.07.B in their entirety and insert the following in their place:

A. OWNER and CONTRACTOR shall execute appropriate Change Orders recommended by ENGINEER covering:

1. Changes in the Work which are: (a) ordered by OWNER pursuant to Paragraph 11.02, (b) required because of acceptance of defective Work under Paragraph 14.04 or OWNER’s correction of defective Work under Paragraph 14.07, or (c) agreed to by the parties;
2. Changes in the Contract Price or Contract Times which are agreed to by the parties, including any undisputed sum or amount of time for Work actually performed in accordance with a Work Change Directive; and
3. Changes in the Contract Price or Contract Times which embody the substance of any written decision rendered by ENGINEER pursuant to Paragraph 12.01; provided that, in lieu of executing any such Change Order, an appeal may be taken from any such decision in accordance with the provisions of the Contract Documents and applicable Laws and Regulations, but during any such appeal, CONTRACTOR shall carry on the Work and adhere to the Progress Schedule as provided in Paragraph 4.04.B.
4. All Contract Change Orders must be concurred by Agency before they are effective or can be eligible for reimbursement.

SC-11.08 Notification to Surety

Add the following new paragraphs immediately after Paragraph 11.08.A:

B. Contractor shall be responsible for notifying the surety of any assignment, modification, or change of the Contract, change in the Work covered thereby, or extension of time for the completion of the project.

C. Failure to provide notice to the surety of any such change shall not exonerate the surety from its obligations under the bond.

SC-12.01.A Claims Process

Insert the following immediately after “Claims Process” in Paragraph 12.01.A:

All Claims, except those waived pursuant to Paragraph 15.07, shall be referred to ENGINEER for decision. A decision by ENGINEER shall be required as a condition precedent to any exercise by OWNER or CONTRACTOR of any rights or remedies either may otherwise have under the Contract Documents or by Laws and Regulations in respect of such Claims.

Delete Paragraph 12.01.A.3 in its entirety.

SC-13.02 Allowances

Delete Paragraph 13.02.C in its entirety and insert "Deleted" in its place.

SC-13.03 Unit Price Work

Delete Paragraph 13.03.E in its entirety and insert the following in its place:

E. The unit price of an item of Unit Price Work shall be subject to reevaluation and adjustment under the following conditions:

1. If the Bid price of a particular item of Unit Price Work amounts to 15% or more of the Contract Price and the variation in the quantity of that particular item of Unit Price Work performed by Contractor differs by more than 25% from the estimated quantity of such item indicated in the Agreement; and
2. If there is no corresponding adjustment with respect to any other item of Work; &
3. If Contractor believes that it has incurred additional expense as a result thereof; or
4. If Owner believes that the quantity variation entitles it to an adjustment in the unit price,

either Owner or Contractor may make a Claim for an adjustment in the Contract Price in accordance with Article 10 if the parties are unable to agree as to the effect of any such variations in the quantity of Unit Price Work performed.

SC-14.02.A Tests and Inspections

Add the following to the beginning of Paragraph 14.02.A:

All Work is subject to testing to indicate compliance with Contract Document requirements. Duplicate copies of test results of all tests required shall be submitted to Engineer. Tests and inspection of work may be conducted by Owner or an independent laboratory employed by Owner. Tests may also be performed in the field by Engineer as a basis for acceptance of the Work.

Add the following to the end of Paragraph 14.02.A:

Samples required for testing shall be furnished by Contractor at no cost to Owner. In the event that completed Work does not conform to specification requirements during the initial test, the Work shall be corrected and retested for conformance. The entire cost of retesting completed Work shall be borne by Contractor. This shall include the extra cost for inspection to Owner which will be deducted from the final amount due Contractor.

SC-14.03 Defective Work

Add Paragraph 14.03.G:

G. Installation of Materials that are non-compliant with American Iron and Steel requirements shall be considered defective work.

SC-15.01 Progress Payment

SC 15.01.B Amend the second sentence of Paragraph 15.01.B.1 by striking out the following text: “a bill of sale, invoice, or other.”

SC 15.01.B.3 Add the following language at the end of paragraph 15.01.B.3:

No payments will be made that would deplete the retainage, place in escrow any funds that are required for retainage, or invest the retainage for the benefit of the Contractor.

SC 15.01.B.4 Add the following new Paragraph after Paragraph 15.01.B.3:

The Application for Payment form to be used on this Project is RD Form 1924-18. The Agency must approve all Applications for Payment before payment is made.

SC 15.01.B.5 Add the following new Paragraph after Paragraph 15.01.B.4:

By submitting Materials for payment, Contractor is certifying that the submitted Materials are compliant with American Iron and Steel requirements. Manufacturer’s Certification letter for Materials satisfy this certification. Refer to Manufacturer’s Certification Letter provided in these Contract Documents.

SC 15.01.C.2.d Add the following new Paragraph after Paragraph 15.01.C.2.c:

d. the Materials presented for payment comply with American Iron and Steel.

SC 15.01.D.1 Delete Paragraph 15.01.D.1 in its entirety and insert the following in its place:

The Application for Payment with Engineer’s recommendations will be presented to the Owner and Agency for consideration. If both the Owner and Agency find the Application for Payment acceptable, the recommended amount less any reduction under the provisions of Paragraph 15.01.E will become due twenty (20) days after the Application for Payment is presented to the Owner, and the Owner will make payment to the Contractor.

SC-15.02 Contractor’s Warranty of Title

SC 15.02.A Amend Paragraph 15.02.A by striking out the following text: “no later than seven days after the time of payment by Owner” and insert “no later than the time of payment by Owner.”

SC-15.03 Substantial Completion

Modify 15.03.A by adding the following after the last sentence: “Services required to determine and certify that to the best of the Contractor’s knowledge and belief all substitutes, equals, and all iron and steel products proposed in the shop drawings, Change Orders and Partial Payment Estimates are either produced in the United States or are the subject of an approved waiver. Services required to certify that, to the best of the Contractor’s knowledge, all those products installed for the project are either produced in the United States or are the subject of an approved waiver.”

SC-15.04 Partial Utilization

Add the following new paragraph immediately after Paragraph 15.04.A.3:

4. Owner may at any time request Contractor in writing to permit Owner to take over operation of any part of the Work although it is not substantially complete. A copy of such request will be sent to Engineer, and within a reasonable time thereafter, Owner, Contractor,

and Engineer shall make an inspection of that part of the Work to determine its status of completion and will prepare a list of the items remaining to be completed or corrected thereon before final payment. If Contractor does not object in writing to Owner and Engineer that such part of the Work is not ready for separate operation by Owner, Engineer will finalize the list of items to be completed or corrected and will deliver such lists to Owner and Contractor together with a written recommendation as to the division of responsibilities pending final payment between Owner and Contractor with respect to security, operation, safety, maintenance, utilities, insurance, warranties, and guarantees for that part of the Work which will become binding upon Owner and Contractor at the time when Owner takes over such operation (unless they shall have otherwise agreed in writing and so informed Engineer). During such operation and prior to Substantial Completion of such part of the Work, Owner shall allow Contractor reasonable access to complete or correct items on said list and to complete other related Work.

Paragraph 15.04.A.4 shall be renumbered to 15.04.A.5.

SC-15.08.A Correction Period

Delete in Paragraph 15.08.A the phrase “If within one year after the date of Substantial Completion” and insert in its place the following:

“If thereof began operating or was used in a continuous, satisfactory manner for its intended purpose within one year of the date of final payment or from the date established by Engineer that the Work or portion, whichever is earlier,”

SC-16.02 Owner May Terminate for Cause

Add the following new paragraphs immediately after Paragraph 16.02.B.2:

3. complete the Work as Owner may deem expedient at the expense of Contractor and surety;
 4. apply the amounts retained from partial payments to the completion of the Work;
- and
5. authorize the surety to complete the steps in Paragraphs 16.02.B.1 through 4.

SC-16.03 Owner May Terminate for Convenience

Add the following paragraph after Paragraph 16.03.B:

C. Contractor shall require similar provisions contained in Paragraph 15.03 in each of its subcontracts to protect Contractor from claims by Subcontractors arising from the Owner's termination for convenience, or to minimize claims by such subcontractors. The remedy provided to Contractor under this Paragraph 16.03 shall be Contractor's sole remedy in the event of termination for convenience by Owner.

SC-18 Miscellaneous

SC 18.09 Add the following new paragraph after Paragraph 18.08:

Tribal Sovereignty. No provision of this Agreement will be construed by any of the signatories as abridging or debilitating any sovereign powers of the {insert name of Tribe} Tribe; affecting the trust-beneficiary relationship between the Secretary of the Interior, Tribe, and Indian landowner(s); or interfering with the government-to-government relationship between the United States and the Tribe.

SC 19 Add Article 19 titled "FEDERAL REQUIREMENTS"

SC 19.01 Add the following language as Paragraph 19.01 with the title "Agency Not a Party":

A. This Contract is expected to be funded in part with funds provided by Agency. Neither Agency, nor any of its departments, entities, or employees is a party to this Contract.

SC 19.02 Add the following sections after Article 19.01 with the title "Contract Approval":

A. Owner and Contractor will furnish Owner's attorney such evidence as required so that Owner's attorney can complete and execute the "Certificate of Owner's Attorney" before Owner submits the executed Contract Documents to Agency for approval.

B. Concurrence by Agency in the award of the Contract is required before the Contract is effective.

SC 19.03 Add the following language after Article 19.02.B with the title "Conflict of Interest":

A. Contractor may not knowingly contract with a supplier or manufacturer if the individual or entity who prepared the plans and specifications has a corporate or financial affiliation with the supplier or manufacturer. Owner's officers, employees, or agents shall not engage in the award or administration of this Contract if a conflict of interest, real or apparent, would be involved. Such a conflict would arise when: (i) the employee, officer or agent; (ii) any member of their immediate family; (iii) their partner or (iv) an organization that employs, or is about to employ, any of the above, has a financial interest in Contractor. Owner's officers, employees, or agents shall neither solicit nor accept gratuities, favors or anything of monetary value from Contractor or subcontractors.

SC 19.04 Add the following language after Article 19.03.A with the title "Gratuities":

A. If Owner finds after a notice and hearing that Contractor, or any of Contractor's agents or representatives, offered or gave gratuities (in the form of entertainment, gifts, or otherwise) to any official, employee, or agent of Owner or Agency in an attempt to secure this Contract or favorable treatment in awarding, amending, or making any determinations related to the performance of this Contract, Owner may, by written notice to Contractor, terminate this Contract. Owner may also pursue other rights and remedies that the law or this Contract provides. However, the existence of the facts on which Owner bases such findings shall be an issue and may be reviewed in proceedings under the dispute resolution provisions of this Contract.

B. In the event this Contract is terminated as provided in paragraph 19.04.A, Owner may pursue the same remedies against Contractor as it could pursue in the event of a breach of this Contract by Contractor. As a penalty, in addition to any other damages to which it may be entitled by law, Owner may pursue exemplary damages in an amount (as determined by Owner) which shall not be less than three nor more than ten times the costs Contractor incurs in providing any such gratuities to any such officer or employee.

SC 19.05 Add the following language after Article 19.04.B with the title "Audit and Access to Records":

A. Owner, Agency, the Comptroller General of the United States, or any of their duly authorized representatives, shall have access to any books, documents, papers, and records of the Contractor which are pertinent to the Agreement, for the purpose of making audits, examinations, excerpts, and transcriptions. Engineer shall maintain all required records for three years after final payment is made and all other pending matters are closed.

SC 19.06 Add the following language after Article 19.05.A with the title “Small, Minority and Women’s Businesses”:

A. If Contractor intends to let any subcontracts for a portion of the work, Contractor shall take affirmative steps to assure that small, minority and women’s businesses are used when possible as sources of supplies, equipment, construction, and services. Affirmative steps shall consist of: (1) including qualified small, minority and women’s businesses on solicitation lists; (2) assuring that small, minority and women’s businesses are solicited whenever they are potential sources; (3) dividing total requirements when economically feasible, into small tasks or quantities to permit maximum participation of small, minority, and women’s businesses; (4) establishing delivery schedules, where the requirements of the work permit, which will encourage participation by small, minority and women’s businesses; (5) using the services and assistance of the Small Business Administration and the Minority Business Development Agency of the U.S. Department of Commerce; (6) requiring each party to a subcontract to take the affirmative steps of this section; and (7) Contractor is encouraged to procure goods and services from labor surplus area firms.

SC 19.07 Add the following after Article 19.06.A with the title “Anti-Kickback”:

A. Contractor shall comply with the Copeland Anti-Kickback Act (18 USC 874 and 40 USC 276c) as supplemented by Department of Labor regulations (29 CFR Part 3, “Contractors and Subcontractors on Public Buildings or Public Works Financed in Whole or in Part by Loans or Grants of the United States”). The Act provides that Contractor or subcontractor shall be prohibited from inducing, by any means, any person employed in the construction, completion, or repair of public facilities, to give up any part of the compensation to which they are otherwise entitled. Owner shall report all suspected or reported violations to Agency.

SC 19.08 Add the following after Article 19.07.A with the title “Clean Air and Pollution Control Acts”:

A. If this Contract exceeds \$100,000, compliance with all applicable standards, orders, or requirements issued under section 306 of the Clean Air Act (42 U.S.C. 1857(h) and 42 USC 7401et. seq.), section 508 of the Clean Water Act (33 U.S.C. 1368) and Federal Water Pollution Control Act (33 USC 1251 et seq.), Executive Order 11738, and Environmental Protection Agency regulations is required. Contractor will report violations to the Agency and the Regional Office of the EPA.

SC 19.09 Add the following after Article 19.08 with the title “State Energy Policy”:

A. Contractor shall comply with the Energy Policy and Conservation Act (P.L. 94-163). Mandatory standards and policies relating to energy efficiency, contained in any applicable State Energy Conservation Plan, shall be utilized.

SC 19.10 Add the following after Article 19.09 with the title “Equal Opportunity Requirements”:

A. If this Contract exceeds \$10,000, Contractor shall comply with Executive Order 11246, “Equal Employment Opportunity,” as amended by Executive Order 11375, “Amending Executive Order 11246 Relating to Equal Employment Opportunity,” and as supplemented by regulations at 41 CFR part 60, “Office of Federal Contract Compliance Programs, Equal Employment Opportunity, Department of Labor.”

B. Contractor’s compliance with Executive Order 11246 shall be based on its implementation of the Equal Opportunity Clause, specific affirmative active obligations required by the Standard Federal Equal Employment Opportunity Construction Contract Specifications, as set forth in 41

CFR Part 60-4 and its efforts to meet the goals established for the geographical area where the Contract is to be performed. The hours of minority and female employment and training must be substantially uniform throughout the length of the Contract, and in each trade, and Contractor shall make a good faith effort to employ minorities and women evenly on each of its projects. The transfer of minority or female employees or trainees from Contractor to Contractor or from project to project for the sole purpose of meeting Contractor's goals shall be a violation of the Contract, the Executive Order, and the regulations in 41 CFR part 60-4. Compliance with the goals will be measured against the total work hours performed.

C. Contractor shall provide written notification to the Director of the Office of Federal Contract Compliance Programs within 10 working days of award of any construction subcontract in excess of \$10,000 at any tier for construction work under the Contract resulting from this solicitation. The notification shall list the name, address, and telephone number of the subcontractor; employer identification number; estimated dollar amount of subcontract; estimated starting and completion dates of the subcontract; and the geographical area in which the Contract is to be performed.

SC 19.11 Add the following after Article 19.10.C with the title "Restrictions on Lobbying":

A. Contractor and each subcontractor shall comply with Restrictions on Lobbying (Public Law 101-121, Section 319) as supplemented by applicable Agency regulations. This Law applies to the recipients of contracts and subcontracts that exceed \$100,000 at any tier under a Federal loan that exceeds \$150,000 or a Federal grant that exceeds \$100,000. If applicable, Contractor must complete a certification form on lobbying activities related to a specific Federal loan or grant that is a funding source for this Contract. Each tier certifies to the tier above that it will not and has not used Federal appropriated funds to pay any person or organization for influencing or attempting to influence an officer or employee of any agency, a member of Congress, or an employee of a member of Congress in connection with obtaining any Federal contract, grant, or any other award covered by 31 U.S.C. 1352. Each tier shall disclose any lobbying with non-Federal funds that takes place in connection with obtaining any Federal award. Certifications and disclosures are forwarded from tier to tier up to the Owner. Necessary certification and disclosure forms shall be provided by Owner.

SC 19.12 Add the following after Article 19.11.A with the title "Environmental Requirements":

When constructing a Project involving trenching and/or other related earth excavations, Contractor shall comply with the following environmental conditions:

A. Wetlands –When disposing of excess, spoil, or other construction materials on public or private property, Contractor shall not fill in or otherwise convert wetlands.

B. Floodplains –When disposing of excess, spoil, or other construction materials on public or private property, Contractor shall not fill in or otherwise convert 100-year floodplain areas (Standard Flood Hazard Area) delineated on the latest Federal Emergency Management Agency Floodplain Maps, or other appropriate maps, e.g., alluvial soils on NRCS Soil Survey Maps.

C. Historic Preservation – Any excavation by Contractor that uncovers an historical or archaeological artifact or human remains shall be immediately reported to Owner and a representative of Agency. Construction shall be temporarily halted pending the notification process and further directions issued by Agency after consultation with the State Historic Preservation Officer (SHPO).

D. Endangered Species – Contractor shall comply with the Endangered Species Act, which provides for the protection of endangered and/or threatened species and critical habitat. Should any evidence of the presence of endangered and/or threatened species or their critical habitat be brought to the attention of Contractor, Contractor will immediately report this evidence to Owner and a representative of Agency. Construction shall be temporarily halted pending the notification process and further directions issued by Agency after consultation with the U.S. Fish and Wildlife Service.

E. Mitigation Measures – Environmental mitigation measures for the Project are noted on the Plan Sheets.

SC 19.13 Add the following after Article 19.12.E:

Add “Section 746 of Title VII of the Consolidated Appropriations Act of 2017 (Division A - Agriculture, Rural Development, Food and Drug Administration, and Related Agencies Appropriations Act, 2017) and subsequent statutes mandating domestic preference applies an American Iron and Steel requirement to this project. All iron and steel products used in this project must be produced in the United States. The term “iron and steel products” means the following products made primarily of iron or steel: lined or unlined pipes and fittings, manhole covers and other municipal castings, hydrants, tanks, flanges, pipe clamps and restraints, valves, structural steel, reinforced precast concrete, and construction materials. The de minimis and minor components waiver apply to this contract as defined in the Contract Documents..”

SC 19.14 “Definitions” - Add the following after Article 19.13:

“Assistance recipient” is the entity that receives funding assistance from programs required to comply with AIS requirements in the Consolidated Appropriations Act of 2017 and any subsequent statutes mandating domestic preference. This term includes owner and/or applicant.

“Certifications” means the following:

- *Manufacturers’* certification is documentation provided by the manufacturer or fabricator to various entities stating that the iron and steel products to be used in the project are produced in the United States in accordance with American Iron and Steel (AIS) Requirements. If items are purchased via a supplier, distributor, vendor, etc. vs. from the manufacturer or fabricator directly, then the supplier, distributor, vendor, etc. will be responsible for obtaining and providing these certification letters to the parties purchasing the products.
- *Engineers’* certification is documentation that plans, specifications, and bidding documents comply with AIS.
- *Contractors’* certification is documentation submitted upon substantial completion of the project that all iron and steel products installed were produced in the United States.

“Coating” means a covering that is applied to the surface of an object. If a coating is applied to the external surface of a domestic iron or steel component, and the application takes place outside of the United States, said product would be considered a compliant product under the AIS requirements. Any coating processes that are applied to the external surface of iron and steel components that would otherwise be AIS compliant would not disqualify the product from meeting the AIS requirements regardless of where the coating processes occur, provided that final assembly of the product occurs in the United States. This exemption only applies to coatings on the *external surface* of iron and steel components, such as the lining of lined pipes. All manufacturing processes for lined pipes, including the application of pipe lining, must occur in the United States for the product to be compliant with AIS requirements.

“Contractor” is the individual or entity with which the applicant has contractor (or is expected to) to perform construction services (or for water and waste projects funded by the programs which are

subject to AIS requirements). This includes bidders and/or contractors that have received an award from the applicant and any party having a direct contractual relationship with the owner/applicant. A general contractor is often referred to as the prime contractor.

“Construction materials” are those articles, materials, or supplies made primarily of iron and steel, that are permanently incorporated into the project, not including mechanical and/or electrical components, equipment and systems. Some of these products may overlap with what is also considered “structural steel”.

“Engineer” is an individual or entity with which the owner has contracted to perform engineering/architectural services for water and waste projects funded by the programs subject to AIS requirements).

“De minimis incidental components” are various miscellaneous low-cost components that are essential for, but incidental to, the construction and are incorporated into the physical structure of the project. Examples of incidental components could include small washers, screws, fasteners (such as “off the shelf” nuts and bolts, miscellaneous wire, corner bead, ancillary tube, signage, trash bins, door hardware etc.) Costs for de minimis incidental components cumulatively may comprise no more than a total of five percent of the total cost of the materials used in and incorporated into a project; the cost of an individual item may not exceed one percent of the total cost of the materials used in and incorporated into a project.

“General contractor” is the individual or entity with which the applicant has contracted (*or is expected to*) to perform construction services (or for water and waste projects funded by the programs subject to AIS requirements). This includes bidders, contractors that have received an award from the applicant and any party having a direct contractual relationship with the owner/applicant. A general contractor is often referred to as the prime contractor.

“Iron and steel products” are defined as the following products made primarily of iron or steel: lined or unlined pipes and fittings, manhole covers and other municipal castings, hydrants, tanks, flanges, pipe clamps and restraints, valves, structural steel, reinforced precast concrete, and construction materials. Only items on the above list made primarily of iron or steel, permanently incorporated into the project must be produced in the United States. For example trench boxes, scaffolding or equipment, which are removed from the project site upon completion of the project, are not required to be made of U.S. Iron or Steel.

“Manufacturers” meaning a supplier, fabricator, distributor, materialman, or vendor is an entity with which the applicant, general contractor or with any subcontractor has contracted to furnish materials or equipment to be incorporated in the project by the applicant, contractor or a subcontractor.

“Manufacturing processes” are processes such as melting, refining, forming, rolling, drawing, finishing, and fabricating. Further, if a domestic iron and steel product is taken out of the United States for any part of the manufacturing process, it becomes foreign source material. However, raw materials such as iron ore, limestone and iron and steel scrap are not covered by the AIS requirement, and the material(s), if any, being applied as a coating are similarly not covered. Non-iron or steel components of an iron and steel product may come from non-US sources. For example, for products such as valves and hydrants, the individual non-iron and steel components do not have to be of domestic origin. Raw materials, such as iron ore, limestone, scrap iron, and scrap steel, can come from non-U.S. sources.

“Mechanical equipment” is typically that which has motorized parts and/or is powered by a motor. “Electrical equipment” is typically any machine powered by electricity and includes components that are part of the electrical distribution system. AIS does apply to mechanical equipment.

“Minor components” are components *within* an iron and/or steel product otherwise compliant with the American Iron and Steel requirements. This is different from the de minimis definition where de minimis pertains to the entire project and the minor component definition pertains to a single product. This waiver, would allow non-domestically produced miscellaneous minor components comprising up to five percent of the total material cost of an otherwise domestically produced iron and steel product to be used. However, unless a separate waiver for a product has been approved, all other iron and steel components in said product must still meet the AIS requirements. This waiver does not exempt the whole product from the AIS requirements only minor components within said product and the iron or steel components of the product must be produced domestically. Valves and hydrants are also subject to the cost ceiling requirements described here. Examples of minor components could include items such pins and springs in valves/hydrants, bands/straps in couplings, and other low cost items such as small fasteners etc.

“Municipal castings” are cast iron or steel infrastructure products that are melted and cast. They typically provide access, protection, or housing for components incorporated into utility owned drinking water, storm water, wastewater, and solid waste infrastructure.

“National Office” refers to the office responsible for the oversight and administration of the program nationally. The National Office sets policy, develops program regulations, and provides training and technical assistance to help the state offices administer the program. The National Office is located in Washington, D.C.

“Owner” is the individual or entity with which the general contractor has contracted regarding the work, and which has agreed to pay the general contractor for the performance of the work, pursuant to the terms of the contract for water and waste projects funded by the programs subject to AIS requirements. For the purpose of this Bulletin, this term is synonymous with the term “applicant” as defined in 7 CFR 1780.7 (a) (1), (2) and (3) and is an entity receiving financial assistance from the programs subject to the AIS requirements.

“Pass through Entities” is an entity that provides a subaward to a loan and/or grant recipient to carry out part of a Federal program. Examples are grantees utilizing the Revolving Loan Program and Household Water Well Program and Alaska Native Tribal Health Consortium (ANTHC) or the State of Alaska from the RAVG Program.

“Primarily iron or steel” is defined as a product made of greater than 50 percent iron or steel, measured by cost. The cost should be based on the material costs. An exception to this definition is reinforced precast concrete (see Definitions). All technical specifications and applicable industry standards (e.g. NIST, NSF, AWWA) must be met. If a product is determined to be less than 50 percent iron and steel, the AIS requirements do not apply.

For example, the cost of a fire hydrant includes:

- (1) The cost of materials used for the iron portion of a fire hydrant (e.g. bonnet, body and shoe); and
- (2) The cost to pour and cast to create those components (e.g. labor and energy).

Not included in the cost are:

- (1) The additional material costs for the non-iron and steel internal workings of the hydrant (e.g. stem, coupling, valve, seals, etc.); and
- (2) The cost to assemble the internal workings into the hydrant body.

“Produced in the United States” means that the production in the United States of the iron or steel products used in the project requires that all manufacturing processes must take place in the United States, with the exception of metallurgical processes involving refinement of steel additives.

“Project” is the total undertaking to be accomplished for the applicant by consulting engineers, general contractors, and others, including the planning, study, design, construction, testing, commissioning, and start-up, and of which the work to be performed under the contract is a part. A project includes all activity that an applicant is undertaking to be financed in whole or part by programs subject to AIS requirements. The intentional splitting of projects into separate and smaller contracts or obligations to avoid AIS requirements is prohibited.

“Reinforced Precast Concrete” may not consist of at least 50 percent iron or steel, but the reinforcing bar and wire must be produced in the United States and meet the same standards as for any other iron or steel product. Additionally, the casting of the concrete product must take place in the United States. The cement and other raw materials used in concrete production are not required to be of domestic origin. If the reinforced concrete is cast at the construction site, the reinforcing bar and wire are considered to be a construction material and must be produced in the United States.

“Steel” means an alloy that includes at least 50 percent iron, between 0.02 and 2 percent carbon, and may include other elements. Metallic elements such as chromium, nickel, molybdenum, manganese, and silicon may be added during the melting of steel for the purpose of enhancing properties such as corrosion resistance, hardness, or strength. The definition of steel covers carbon steel, alloy steel, stainless steel, tool steel, and other specialty steels.

“Structural steel” is rolled flanged shapes, having at least one dimension of their cross-section three inches or greater, which are used in the construction of bridges, buildings, ships, railroad rolling stock, and for numerous other constructional purposes. Such shapes are designated as wide-flange shapes, standard I-beams, channels, angles, tees, and zees. Other shapes include but are not limited to, H-piles, sheet piling, tie plates, cross ties, and those for other special purposes.

“Ultimate recipient” is a loan or grant recipient receiving funds from a pass-through entity. Examples include: (1) a loan recipient from the Revolving Loan Fund; (2) a loan recipient from the Household Water Well Program; and (3) a grant recipient from ANTHC or the State of Alaska from the RAVG Program.

“United States” means each of the several states, the District of Columbia, and each Federally Recognized Indian Tribe.

Form RD 1924-7
(Rev. 2-97)

UNITED STATES DEPARTMENT OF AGRICULTURE
RURAL DEVELOPMENT AND
FARM SERVICE AGENCY

CONTRACT CHANGE ORDER

ORDER NO.
DATE
STATE
COUNTY

CONTRACT FOR _____

OWNER _____

To _____
(Contractor)

You are hereby requested to comply with the following changes from the contract plans and specifications:

Description of Changes (Supplemental Plans and Specifications Attached)	DECREASE in Contract Price	INCREASE in Contract Price
	\$ _____	\$ _____
TOTALS	\$ _____	_____
NET CHANGE IN CONTRACT PRICE	\$ _____	_____

JUSTIFICATION:

The amount of the Contract will be (Decreased) (Increased) By The Sum Of: _____
_____ Dollars (\$ _____).

The Contract Total Including this and previous Change Orders Will Be: _____
_____ Dollars (\$ _____).

The Contract Period Provided for Completion Will Be (Increased) (Decreased) (Unchanged): _____ Days.

This document will become a supplement to the contract and all provisions will apply hereto.

Requested _____ (Owner) _____ (Date)

Recommended _____ (Owner's Architect/Engineer) _____ (Date)

Accepted _____ (Contractor) _____ (Date)

Approved by Agency _____ (Name and Title) _____ (Date)

Public reporting burden for this collection of information is estimated to average 15 minutes per response, including the time for reviewing instructions, searching existing data sources, gathering and maintaining the data needed, and completing and reviewing the collection of information. Send comments regarding this burden estimate or any other aspect of this collection of information, including suggestions for reducing this burden, to U.S. Department of Agriculture, Clearance Officer, STOP 7602, 1400 Independence Avenue, S.W., Washington, D.C. 20250-7602. Please DO NOT RETURN this form to this address. Forward to the local USDA office only. You are not required to respond to this collection of information unless it displays a currently valid OMB control number.

PROJECT SPECIAL CONDITIONS

1. Project Special Conditions: These Special Conditions supplement the “Standard General Conditions” and the “Supplementary Conditions” within the Contract Documents. The Engineer's decision shall be final as to interpretation and/or conflict between any of the reference specifications and standards contained herein.
2. Additional Definitions: Wherever the following terms are used in these specifications, their meaning shall be construed in accordance with the definitions listed below.
 - a. Engineer: McGhee Engineering, Inc., P.O. Box 267, 202 Ewing Street, Guthrie, Kentucky 42234, telephone (270) 483-9985.
 - b. Inspector: Representative of the Engineer or Owner stationed at, or visiting the site of the work to secure conformity with the Plans and Specifications, to record the work performed by the Contractor and to serve in such other capacities as the Engineer may direct.
 - c. Plans: All drawings adopted by the Engineer and bound herein pertaining to the work under this contract.
 - d. ASTM Specifications: Adopted by the American Society for Testing and Materials, governing the methods and procedures for manufacturing and testing materials and bearing appropriate alphabetical and numerical designations pertinent to the various items involved.
 - e. OSHA: Occupational Health and Safety Administration requirements pertaining to the project.
3. The following abbreviations will be used in these Specifications, the Proposal and contract:

LF or L.F.	Linear Foot
SF or S.F.	Square Foot
LS or L.S.	Lump Sum
EA or Ea	Each
SQ. IN.	Square Inch
LBS.	Pounds
LIN. IN.	Linear Inch

4. Safety Standards and Accident Prevention: With respect to all work performed under this contract, the contractor shall:
 - 4.1 Comply with the safety standards provision of applicable laws, building and construction codes and the “Manual of Accident Prevention in Construction” published by the Associated General Contractors of America, the requirements of the Occupational Safety and Health Act of 1970 (Public Law 91-596), and the requirements of Title 29 of the Code of Federal Regulations, Section 1518 as published in the “federal Register”, Volume 36, No. 75, Saturday, April 17, 1971.
 - 4.2 Exercise every precaution at all times for the prevention of accidents and the protection of persons (including employees) and property.
 - 4.3 Maintain at his/her office or other well known place at the job site, all articles necessary for giving first aid to the injured, and shall make standing arrangements for the immediate removal to a hospital or a doctor's care of persons (including employees), who may be injured on the job site before the employer has made a standing arrangement for removal of injured persons to a hospital or a doctor's care.
5. Completion Time and Liquidated Damages: The project as indicated in the Plans and Specifications shall be completed within the number of consecutive working days stated in the Contract. Contractors shall

submit any request for time extensions at the time of submission of the pay request covering the period during which the time extension is requested, and such requests shall include justification in conformance with the Contract. Failure to make timely submittal of requests for time extension shall be grounds for their denial. The times set forth in the Proposal for completion of work are an essential element of the Contract. The Contractor and Owner understand and agree that a breach of this Contract as to completion on time will cause damage to the Owner. The parties agree that for each and every calendar day the work or any portion thereof shall remain uncompleted after the expiration of the contract time limit, **An amount specified and under the provisions of the Agreement** will be deducted from the money due or to become due the Contractor, not as a penalty, but as liquidated damages and added expense of engineering and overhead.

6. Contractor's Warranty: The Contractor shall guarantee that all work performed under this Contract is new and free of faulty materials in every particular, and free of faulty workmanship, and he does hereby agree to maintain, replace or re-execute without additional cost to the Owner such work found to be unsatisfactory and to make good all damage to his, or work by others affected by this Contract as a result of improper workmanship and materials or due to such required replacement or re-execution.

The Contractor shall warrant all such work for a period of one (1) year from the date of acceptance of all work performed under this Contract. A "Final Certificate" will be issued by the Engineer, as evidence. Neither the "Final Certificate," nor payment, nor any provisions in the Contract Documents shall relieve the Contractor of the guarantee or maintenance provisions, or his responsibility for neglect or the replacement of faulty materials, or workmanship, or any other items of defect during the warranty period.

7. Safety: The Contractor shall be responsible for the safety of himself, his employees and other persons, as well as for the protection of the safety of the improvements being erected and the property of himself or any other person, as a result of his operation. All work shall be done in accordance with the Occupational Safety and Health Administration regulations and all other current federal, state and local laws pertaining to occupational safety, health and welfare. All monitoring and testing required to assure compliance with such requirements shall be the responsibility of the Contractor. The safety of the public, protection of property, and convenience of traffic shall be of prime importance during construction. In all respects, public safety and protection of property and provisions therefor, made necessary by the work, shall be the direct responsibility of the Contractor and shall be performed at his expense.

8. Contractor's Responsibility for Materials and Equipment: The Contractor shall assume full responsibility for all supplies, materials and equipment furnished or installed by him for the work he contracts to do, whether furnished by him or by other parties, until the same shall have been installed and finally tested and accepted by the Engineer. The Contractor shall, therefore, insure such property against loss or damage while stored at the site of the work.

9. Permits, Licenses and Laws: The Contractor shall obtain, at his own expense, all necessary permits and licenses from the proper authorities and shall give all notice required by law or ordinance and shall pay all fees and charges incidental to the due and lawful prosecution of the work and shall comply with all laws, ordinances and regulations relating thereto. Contractor shall obtain necessary building permits; however, there shall be no fees charged to the Contractor by the Owner.

The Owner shall not be responsible to the Contractor for expenses incurred while performing the work under this contract due to the requirements and conditions imposed on the Contractor by any governmental agencies. The Contractor shall investigate with said government as to the requirements and conditions to be imposed.

Copies of said permits, licenses, authorizations or regulations shall be filed with the Owner through the Engineer or his representative. In the event that any work to be performed by the Contractor under the above mentioned permits is found to be unsatisfactory and is not approved by the aforementioned governmental authorities, the cost thereof shall be charged to the Contractor and shall be withheld by the Owner from any money due to the Contractor under the subject construction contract.

10. Labor Laws: The Contractor shall comply with, and shall cause all subcontractors to comply with, the requirements of all applicable labor laws (hours of work, minimum wage, prevailing wage, etc.).

11. Protection of Adjoining Property: Any damage to any property of the Owner or other caused by the Contractor's operations shall be corrected at the Contractor's expense.

Reasonable care shall be taken during construction to avoid damage to vegetation. Ornamental shrubbery and tree branches shall be temporarily tied back, where appropriate, to minimize damage. Trees that receive damage to branches shall be trimmed of those branches to improve the appearance of the tree. Tree trunks receiving damage from equipment shall be treated with a tree dressing.

Minimize siltation and soil erosion during construction.

12. Cleanup: Upon completion of the work and before acceptance and final payment by the Owner, the Contractor shall remove rubbish, unused materials and temporary structures from the limits of the project and restore, in a manner acceptable to the Engineer, all property both public and private that has been damaged during prosecution of the work, and shall level and grade all portions of the work where the surface of the ground or street surface has been disturbed during construction and shall leave the site of the work in a neat and presentable condition, free from ruts and holes. Areas where vegetation is disturbed by construction shall be graded and re-seeded to the satisfaction of the Owner.

Materials associated with the project shall not be deposited on adjacent property unless prior approval has been obtained from the property owner involved.

No extra payment will be made for these cleanup requirements, its cost being included in the various unit prices bid in this proposal.

13. Resident Construction Observation: The Owner may employ the services of a resident construction observer during construction of the project. The purpose of the resident construction observer is to provide additional assurances to the owner as to the quality of the work and the conformance of the work to the plans and specifications. The resident construction observer is not provided to act as a supervisor of the contractor's activities, nor to take responsibility for the quality or safety of the contractor's work. Such responsibilities remain exclusively with the contractor.
14. Basis of Payment: The basis of payment for all items involved with the project will be made according to the units described in the Proposal breakdown. If there are any conflicts between the basis of payment described in the Specification and the units described in the Proposal breakdown, then the Proposal breakdown will prevail.
15. Inclement Weather: The basis of contract time is calendar days. If during the course of the project, weather conditions prevail that preclude performance of productive work for a number of days in excess of that which would normally be expected for the period, the Contractor may request a compensating time extension.
16. Change Orders: Change Orders to the construction contract must comply with DOW Procurement Guidance for Construction and Equipment Contracts. For Change Orders exceeding \$100,000, DOW Procurement Guidance for Construction and Equipment Contracts require cost, pricing and certification.
17. Schedules: The contractor shall provide project construction and payment schedules to the Engineer for approval.
18. Overtime Pay: If state labor laws apply to the project, the Contractor shall compensate for overtime pay for work in excess of an 8-hour day.

END OF SECTION

SUMMARY OF WORK

1.0 GENERAL

1.1 Work Included

The work to be performed involves the purchase and installation of all equipment, hardware & software for use in implementing an automated water meter reading system throughout the Guthrie water system (Todd County), as described by the Contract Drawings and Specifications.

1.2 Patented or Proprietary Materials

This Solicitation specifies requested items. It is not the intention of this Solicitation to eliminate Manufacturers or Contractors of similar or equal equipment of the types specified. It should be noted, however, that these requested items are written around specific requirements and needs of the Owner.

The Contractor acknowledges to and for the benefit of the City of Guthrie (“Purchaser”) and the Commonwealth of Kentucky (the “State”) that it understands the goods and services under this Agreement may be funded with monies made available by the Cleaner Water Program grant funds that could have statutory requirements commonly known as “American Iron and Steel;” that requires all of the iron and steel products used in the project to be produced in the United States (“American Iron and Steel Requirement”) including iron and steel products provided by the Contractor pursuant to this Agreement. The Contractor hereby represents and warrants to and for the benefit of the Purchaser and the State that (a) the Contractor has reviewed and understands the American Iron and Steel Requirement, (b) all of the iron and steel products used in the project will be and/or have been produced in the United States in a manner that complies with the American Iron and Steel Requirement, unless a waiver of the requirement is approved, and (c) the Contractor will provide any further verified information, certification or assurance of compliance with this paragraph, or information necessary to support a waiver of the American Iron and Steel Requirement, as may be requested by the Purchaser or the State. Notwithstanding any other provision of this Agreement, any failure to comply with this paragraph by the Contractor shall permit the Purchaser or State to recover as damages against the Contractor any loss, expense, or cost (including without limitation attorney’s fees) incurred by the Purchaser or State resulting from any such failure (including without limitation any impairment or loss of funding, whether in whole or in part, from the State or any damages owed to the State by the Purchaser). While the Contractor has no direct contractual privity with the State, as a lender to the Purchaser for the funding of its project, the Purchaser and the Contractor agree that the State is a third-party beneficiary and neither this paragraph (nor any other provision of this Agreement necessary to give this paragraph force or effect) shall be amended or waived without the prior written consent of the State.

The Bidder/Contractor shall submit Manufacturers’ Certification letter of compliance with American Iron & Steel Requirement.

If discrepancies or ambiguities are found in the plans, specifications, contract documents or in any communication to the contractor regarding specified materials not compliant with the American Iron and Steel requirement, the contractor shall immediately notify the Engineer in writing.

2.0 CONTRACTOR'S DUTIES

2.1 Construction and Related Activities

The Contractor shall provide and pay for all labor, materials, equipment, machinery, tools, superintendence, insurance, bonds, shipping, sampling and testing, utilities, and other costs required for a complete and functioning water line installation.

2.2 Taxes

The Contractor shall pay all required sales taxes, payroll taxes, consumer and use taxes, and other taxes relating to the work of the project.

2.3 Permits

The contractor shall secure and pay for all legally required permits, licenses and fees associated with the construction. In particular, the Contractor shall:

- A. Comply with Kentucky Transportation Cabinet work requirements when encroaching upon state rights-of-way.
- B. Comply with Todd County Road and/or Guthrie Street Department work requirements when encroaching upon local rights-of-way.

2.4 Notices

The Contractor shall provide all required notices, including notices to utility owners of intent to excavate in the vicinity of their utilities, notices to property owners of intent to enter their property for construction purposes, notices regarding the interruption of any utility service, as well as other notices required by the plans and contract documents.

2.5 Laws

Contractor shall fully comply with all applicable laws, ordinances, rules, regulations, orders and other legal requirements, and shall bear the cost of such compliance.

2.6 Character of Workmen

Contractor shall employ workman and foremen with sufficient knowledge of and experience in the type of work proposed to assure satisfactory performance. Workman shall maintain a professional demeanor and appearance at all times on the project. Any workman on the project who performs work in an incompetent manner, or acts in a disorderly or intemperate manner shall be removed from the project, and may not be employed on any portion of the project unless approved by the Owner.

2.7 Notice of Discrepancies

If discrepancies or ambiguities are found in the plans, specifications, contract documents or in any communication to the contractor, the contractor shall immediately notify the Engineer in writing. Do not proceed with the affected work until clarification is received.

2.8 Inspection

Provide at all times, access to the work for inspection by representatives of the Owner, the Engineer, and regulatory authorities having jurisdiction over the project.

3.0 CONTRACTOR'S USE OF PREMISES

Todd County is the site of all work on this Project.

- a. **RIGHTS-OF-WAY AND EASEMENTS:** The owner has legal authority to construct these facilities on property owned by the Owner, within easements on private property, and on existing public rights-of-way and will provide any other required permanent and construction easements for the pipeline. Access to the site of the work is the responsibility of the Contractor. Contractor shall confine his operations to right-of-ways, easements and property obtained by the Owner for construction of the project, or to areas secured by the Contractor for his use. Contractor shall take precautions to minimize disruption to existing properties.

- b. LOCATION OF TEMPORARY FACILITIES: Contractor's Field offices, Sub-Contractors' Field Offices, Material Storage Buildings, Material and Equipment Storage Yards, and parking areas for all project workers shall be provided by the Contractor, and located in areas approved by the Engineer. Stored materials, regardless of their location shall be protected by the Contractor from damage, theft or degradation at all times.
- c. DAMAGE TO EXISTING PROPERTY: The Contractor will be held responsible for any damage to existing structures, work, materials, or equipment because of his operations and shall repair or replace any damaged structures, work, materials, or equipment to the satisfaction of, and at no additional cost to, the Owner. Stored materials, regardless of their location shall be protected by the Contractor from damage, theft or degradation at all times.

The Contractor shall protect all existing structures and property from damage and shall provide bracing, shoring, or other work necessary for such protection.

4.0 EXISTING FACILITIES

4.1 Existing Utilities

The existing water distribution system will be in continuous operation during the construction of the Project. Contractor shall avoid disturbing existing water facilities, and any other utilities or structures encountered in the work, except as necessary for construction operations. Contractor shall give at least 48 hours prior notice to the Owner, or to any utility or other entity, of any necessary disruptions to service, or work affecting active lines. The Contractor shall be responsible for any necessary damage repair resulting from his installation work

Contractor shall cooperate with Owners personnel in continuing operation of existing facilities.

4.2 Existing Connecting Streets, Roads and Highways

Any damage to a public facility and/or any access road into the project site by construction traffic generated by this project shall be the responsibility of the Contractor. All streets and roads shall be kept open to normal traffic and in a reasonable state of repair. The Contractor shall arrange with the appropriate authority to perform repairs himself or to have the said authority perform them. Any damages to public roads shall be considered a matter of the Contractor's or his suppliers public liability, and needed repairs shall be made as required by the public entity having authority over the road.

Contractor shall provide adequate barricades, warning signs, flagmen, lights, etc., for construction operations hazardous to traffic and public safety.

5.0 PARTIAL OWNER OCCUPANCY

The Owner may, at his discretion, place into service any or all portions of the completed work prior to final completion of all work on the project. Placing a portion of the work in service before final completion does not relieve the contractor of his obligation to complete all work associated with that portion of the line (i.e. clean-up, surface restoration, etc.), to perform maintenance for the required period, or to provide warranty for that portion of the work. If a portion of the work that is placed in service prior to final project completion and acceptance is, in the opinion of the Engineer, complete and ready for acceptance, the Contractor may request that the warranty period for that portion of the work begin at the time it is placed in service, providing that such request is made in writing within seven days of the date of being placed in service. If the request is not made within the required time, the warranty period for that portion of the work will begin upon final acceptance of the Project.

6.0 TEMPORARY FACILITIES

- a. CONTRACTOR'S OFFICE AT SITE OF WORK: Contractor will not be required to provide temporary office facilities, but may do so if desired.

- b. **PARKING:** The Contractor shall provide and maintain suitable parking areas for the use of all construction workers and others performing work or furnishing services in connection with this Contract, as required to avoid any need for such personnel to park personal vehicles in locations where they may interfere with public traffic, Owner's operations, or construction activities. Securing the use of property for parking areas as necessary for the Contractor's operations shall be the full responsibility of the Contractor.
- c. **SANITARY FACILITIES:** The Contractor shall provide and maintain sanitary facilities for the use of his employees or any other persons on the job site, as may be required to comply with the regulations of state and local departments of health.

7.0 TEMPORARY UTILITIES & SERVICES

- a. **WATER:** Water for any purpose will be paid for by the Contractor.
- b. **POWER:** Power for lighting, temporary office facilities, operation of the Contractor's plant or equipment, or for any other use by the Contractor shall be provided by the Contractor at his sole cost and expense. The contractor will be responsible for all necessary arrangements with the utility company.
- c. **HEAT:** All heat necessary for the protection or completion of the work, operation of the Contractor's plant or equipment, or for any other use by the Contractor shall be provided by the Contractor at his sole cost and expense.
- d. **TELEPHONE SERVICE:** The Contractor shall make all necessary arrangements with the telephone utility, and pay all charges therefore, for telephones in his offices at the site, if desired.
- e. **SANITARY SEWER:** The Contractor may make use of portable toilet facilities at his sole cost and expense.

8.0 WORKING HOURS

The Contractor may work on this project during the daylight hours, Monday through Friday, except legal holidays, when weather conditions permit. If the Contractor wishes to work at other times, he may do so if approved by the Engineer and if the request to do so is made at least 48 hours in advance.

END OF SECTION 01-100

SUBMITTALS

1.0 SHOP DRAWINGS, PRODUCT DATA AND SAMPLES

1.1 General

Submit four copies of all required shop drawings to the Utility's Engineer for approval. Do not proceed with work involving any material, supply or method subject to review until approved submittals are received. Allow two weeks for the Utility Engineer's review.

1.2 Submittal Requirements

Submittals shall fully describe the item, material, or construction method proposed, and shall be free of extraneous materials. Submittals shall be adequate to fully document compliance with all requirements of the specifications. Any proposed deviation from the specifications, and the reason therefor shall be noted on the submittal.

By submitting a particular item, material or method, the Contractor states his intention to use that item, material or method exclusively in the work. Once approved, the Contractor may not change items, materials or methods without resubmitting shop drawings. The Engineer reserves the right to reject a re-submittal solely on the basis of maintaining continuity in the work.

Engineer's review of the submittal does not relieve the Contractor of his responsibility to fully comply with all requirements of the Contract Documents.

Shop drawings returned for correction or rejected shall be revised and resubmitted until final approval is granted. No claim will be allowed for damages or time extension because of delays in the work resulting from rejection of submittals not conforming to the specifications.

1.3 Items Requiring Review

Shop drawing submittal and review are required for, but not limited to, the following items (except where such items are supplied by the owner):

- a. PVC/Ductile iron pipe, fittings, meters and hydrants; if applicable.
- b. Pipe Certifications and Test Results; if applicable.
- c. All valves (gate, air release, check, etc.); if applicable.
- d. Aggregates used as bedding or backfill (source and gradation).
- e. Precast concrete items; if applicable.
- f. Access hatch and covers; if applicable.
- g. Tracer wire & tracer wire splice kit material.
- h. Pipeline markers; if applicable.
- i. Meter Service components (i.e. saddles, service tubing, couplings, setters, meter box, meter lids, nipples, etc.)
- j. Automated Water Meter, including hardware, software, communication endpoints, etc.

2.0 CLOSEOUT

Before final payment on the project, deliver to the Engineer the following items.

1. Notarized release of liens from all subcontractors, equipment and material suppliers.
2. Written warranties and guarantees.
3. Written manufacturers' certifications regarding compliance to American Iron & Steel Provisions.
4. **Record of installations. Provide a complete list of actual meters installed including customer name, account number, address of installation, & meter/register number.**

END OF SECTION 01-200

WATER MAIN GENERAL REQUIREMENTS

1.0 GENERAL

1.1 Scope of Work

The water mains and appurtenances required on this contract shall be furnished in full compliance with the contract specifications and contract drawings.

Work to be performed under the unit price items, described subsequently herein, shall include for each item all excavation (including rock excavation, if any) the removal of existing pavements, curb and gutter, sidewalks, driveways, brush and timber, structures and piping to be relocated or abandoned; also sheeting, diking, well pointing, bailing, dewatering; the furnishing, placing and removal of bulkheads, the restoration of any utilities, parkways, trees, shrubbery, culverts, fences and other items disturbed by construction operations; backfilling and removal of excess excavated materials; and testing.

The cost of all such work and the cost of other work necessary for the complete water line installation shall be included in the unit price pay items provided.

1.2 Standards

Where materials and methods are indicated in the Specifications as being in conformance with a standard specification (i.e. AWWA, ASTM, etc.) it shall refer in all cases to the latest edition of the specification or standard, and shall include all interim revisions. Listing of a standard specification without further reference shall indicate that the particular material or method shall conform to the referenced specification.

2.0 WORK INCIDENTAL TO CONSTRUCTION

Work to be performed under this heading includes all the work designated as "incidental to construction" and other work required by the plans, specifications or contract documents in order to fully complete the work on the project, but not provided with a specific pay item in the bid form. The contractor shall perform such work, and the contractor shall include all charges for the work in the bid items provided. No claim for additional compensation based upon required work not being described in a bid item will be considered.

2.1 Public and Private Utilities

Where **any** utilities (including those of the Owner), such as water, sewer, telephone, power, oil or gas transmission, or any other, either public or private are encountered, the contractor shall provide adequate protection for them and will be held responsible for any damage to such utility from his operations. When it is apparent that construction operations may damage the integrity of any utility conduit or pole, or the support of any structure, the contractor shall notify the utility owner of this possibility and shall take such steps as may be required to provide temporary bracing or support of the affected conduit, pole or structure.

The cost of any bracing or support of conduits, poles or structures encountered in the work shall be included in the bid item for water main construction.

When, in order to carry out the work, a pole, conduit or structure is required to be removed or relocated, the contractor shall be responsible for making all arrangements with the utility owner for such removal or relocation. All costs for such relocation or removal shall be born by the contractor unless it could not be reasonably foreseen that such work would be required.

All damage to utilities resulting from the contractors operations shall be repaired at the contractor's expense. Where it is the policy of the utility to perform their own repairs to damaged utilities, the contractor shall cooperate fully with the utility and bear the costs of such repairs.

2.2 Existing Water, Sewer and Drain Facilities

In some instances, existing water, sewer or drains may be encountered along the line of work. In all such cases, the contractor shall perform his operations in such manner that the service will not be interrupted, and shall, at his expense, make temporary provisions to maintain such services.

Where it is necessary to cut, remove and/or replace existing storm sewers and drain tiles, the Contractor shall make specific arrangements to maintain the flow of water and shall not place permanent bulkheads in any conduit. Temporary earth dams may be used to confine and/or channel the flow and shall be removed upon completion of the crossing.

The Contractor shall receive no extra compensation for replacement of drains encountered or for relaying same at a new grade or line. Where existing water mains are encountered in the work they shall be maintained in operation to the extent that water service is not interrupted.

2.3 Existing Gas, Electric and Other Facilities

Where existing gas mains are encountered, the Contractor shall arrange with the Gas Utility for any necessary location and relaying.

The Contractor will give adequate notice to the Gas Utility to allow their location of gas lines ahead of the proposed construction with paint or stakes. The Contractor will be required to expose the gas mains prior to dynamiting and excavation, where crossing pipeline installations. Track drill operations will be ceased short of the gas main and will resume on the other side of the main. The material under the gas line will be removed with hand drills and/or jack hammers. The Contractor shall contact the Gas Utility for restrictions on blasting in the vicinity of the gas line, comply therewith.

Before backfilling a trench in which a gas main has been exposed, the Contractor shall notify the Gas Utility to inspect the exposed main and perform any protective measures deemed necessary.

The forgoing provisions pertaining to gas lines shall apply to all natural gas, petroleum and other pipelines.

Where existing underground electric or telephone facilities are encountered, the Contractor shall take the necessary measures to work around the facilities or arrange with the Electric Company or Telephone Company for any necessary relaying. Repairs made necessary by damage to any facilities by the Contractor shall be charged to the Contractor.

2.4 Dewatering

The Contractor shall perform all pumping, well pointing, ditching and any other necessary procedure to keep the excavation clear of groundwater, storm water, or sewage during the progress of the work and until the completed work is safe from injury.

The Contractor shall maintain dewatering operations such that no groundwater, storm water, or sewage will be allowed to build up over any concrete and/or masonry at manholes or structures for a period of 6 hours. This time period will be adjusted by the Engineer should temperature and curing conditions warrant.

All water pumped or drained from the work shall be disposed of in a manner satisfactory to the Engineer without damage to adjacent property or to other work under construction. The contractor shall not dispose of storm or surface water through sanitary sewerage facilities.

It shall be the Contractor's responsibility to take all necessary precautions to protect all construction against flooding and/or flotation from hydrostatic uplift.

All dewatering procedures and maintenance thereof shall be considered an incidental part of pipe laying and construction operations and no separate payment will be allowed therefor.

Dewatering operations for structure construction shall be such that the groundwater or surface water is not being pulled over, around, or through the freshly placed concrete or masonry. The use of multiple pumps in the trench may be required. When required to protect the freshly placed concrete and/or masonry, timber or plywood forms will be positioned around in the concrete or masonry so that the dewatering operations will not cause a separation of cement and aggregate. The cost of these dewatering and/or protection procedures shall be merged into the appropriate bid items.

2.5 Barricades And Warning Signs

The Contractor shall furnish, erect, and maintain such barricades, fences, lights, and danger signals and take other precaution measures that will insure the protection of persons, property and the work.

2.6 Maintenance and Access of Traffic

Portions of the work are located in developed areas requiring the access for fire and other departments to be provided for at least one free lane be available for all traffic. Contractors are to arrange operations in these areas to meet these requirements and secure approval of operating procedures from the Logan County Road Department or the Kentucky Department of Highways as appropriate.

Where water mains are constructed under paved roadway surfaces, within public right-of-ways, the Contractor will restore the asphalt or crushed stone pavement and/or shoulders between shoulder lines. It shall be the responsibility of the Contractor, upon completion of the installation, to regrade the street to the template that existed prior to construction. This regrading shall be satisfactory to Logan County or the Kentucky Department of Highways.

The Contractor shall further be responsible for the maintenance of disturbed streets until re-paving operations have been completed.

The Contractor shall restore all curbs, gutters, sidewalks, ramps and private driveways or parking lots. This work shall be considered as incidental to the construction of the proposed water main and, therefore, no additional compensation will be allowed for the restoration of these items.

The Contractor shall also be required to restore, at his own expense, all pavements disturbed by his operations where the water main was not constructed under the pavements. He shall further be required to replace at his own expense all pavements disturbed in the correction of water main deficiency discovered after restorations have been completed.

3.0 MATERIAL AND EQUIPMENT

Materials, products and equipment shall be properly containerized, packaged, boxed and protected to prevent damage during transportation and handling. Provide suitable temporary weather tight storage facilities as may be required for materials or equipment which will be damaged by storage in the open. Protect from damage all materials delivered at the site. Do not use damaged material on the work.

Manufactured articles, materials and equipment shall be applied, installed, connected, erected, used, cleaned and conditioned as directed by the respective manufacturers unless directed otherwise by the provisions of these Specifications.

4.0 SPECIAL CONDITIONS

The Contractor's attention is called to the special conditions (i.e. stream crossings, road crossings, construction in road right-of-way, etc.) indicated on the Plans. The Plans and Specifications reflect the type of construction that is anticipated in the various locations requiring special attention, but it shall be the responsibility of the Contractor to contact the various agencies including the State Highway Department, the Gas Company, Telephone Company, Corps of Engineers, and other utilities and/or entities involved when working in areas where they will be concerned, and for coordinating construction with their requirements in such a way to avoid conflicts, damage or interruptions in service.

- (a) The Contractor shall perform his work in such a manner that normal service on existing water lines and service to customers is maintained to the maximum extent possible. Such service shall be disrupted only at times and in such a manner as approved by the Engineer.
- (b) The Contractor shall submit a work schedule to the Engineer for approval prior to beginning work. The schedule shall establish the planned sequence of line installation, service switch-over if required and property restoration for the project.
- (c) The Contractor shall maintain access to businesses and residences to the maximum extent possible.
- (d) Easement Restrictions - The Contractor shall exercise due care in staying within the easements obtained for the proposed construction, and will be held strictly accountable for violations thereof. Any additional access to or use of private property must be arranged by the Contractor, at his expense, by negotiation with the property owner involved.

The Contractor's attention is also called to the special conditions associated with the proximity of the Owner's existing water distribution system in relation to improvements indicated on the Plans. The proposed improvements will be constructed adjacent to and/or may encounter existing water lines which must remain in service until the successful testing and completion of the proposed improvements. The Contractor is reminded of paragraph 2.1 of Section 02-100, and the Contractor is urged to use the most appropriate construction measures to produce a suitable finished product while maintaining the integrity of the existing infrastructure.

5.0 TESTING

The Specifications for materials designate the testing applicable for materials incorporated in the work. Testing shall be done by the manufacturer in accordance with the applicable ASTM specification. Manufacturer shall furnish the Engineer with three (3) certified copies for the test results.

The Owner may, at his option, elect to have an independent testing laboratory test materials to be furnished for incorporation in the work. Such testing, when done, shall be in accordance with provisions of the Specifications for Materials.

Acceptance testing for installed water line will be limited to visual testing, disinfection testing and pressure testing unless directed otherwise by the Engineer.

6.0 SUBMITTALS

Submittals for this work include, but are not limited to, those items listed in Section 01-200. Provide at least four copies of each submittal, and allow two weeks for Engineer's review. Such submittals are to be approved by Engineer prior to incorporation of any materials into the work.

7.0 WARRANTY

The labor and installation work to be performed under this Contract shall be guaranteed against defects in materials or workmanship for a period of one year following the date of formal acceptance of the project (Note: Product warranty for the Automated Meter Read equipment shall be in accordance with the respective products detailed in Section 02-201.)

In the event defects in materials or workmanship should appear, the Contractor shall promptly make the necessary correction. When the defects are not of an emergency nature, The Contractor will be notified and will be given a period of two weeks in which to make the necessary corrections. Should the defect be of an emergency nature, which in the opinion of the Owner or the Engineer requires immediate correction, the Contractor will be notified and requested to make the necessary repair immediately. Should this be impractical, or if the Contractor should fail to respond to the request for corrective action within the specified period, the Owner may proceed to have the defects corrected and shall bill the Contractor for all charges in connection therewith including labor, materials, and equipment rental. Such charges may be deducted from amounts due the Contractor if any of the Contractor's money has been withheld. In the

event the Contractor fails, refused, or neglects to pay the Owner, the Surety shall be liable for such charges.

8.0 MAINTENANCE OBLIGATION

The Contractor shall be fully responsible for maintenance of any and all portions of the work, which he performs under this Contract for a period of 30 days. This maintenance obligation shall begin upon formal acceptance of the project and is intended to place a limit upon the Contractor's responsibility for normal maintenance required for the routine operation of the system. This 30-day obligation shall not be construed as relieving the Contractor of the responsibility for maintenance or repair work resulting from defective materials or workmanship during the warranty period.

9.0 PROJECT CLOSEOUT

The premises and the job site shall be maintained in a reasonably neat and orderly condition and kept free from an accumulation of waste materials and rubbish during the entire construction period. Remove crates, cartons and other flammable waste materials or trash from the work areas at the end of each working day.

When the Contractor requests a final inspection, Engineer and/or Owner will inspect the work for completeness in accordance with the Contract Documents. The contractor shall promptly correct any deficiencies.

Final acceptance cannot be made until the Contractor furnishes to the Owner a notarized certification in a form suitable to the Owner that all labor and material costs for the work have been paid by the Contractor and that there are no liens against the work.

Payment in full of the final Application for Payment shall constitute acceptance of the work by the Owner subject to conditions of the Contract Documents.

END OF SECTION 02-100

WATER MAIN MATERIALS

1.0 GENERAL

All materials to be incorporated in the project shall be first quality, new and undamaged material conforming to all applicable portions of these Specifications.

1.1 Patented or Proprietary Materials

This Solicitation specifies requested items. It is not the intention of this Solicitation to eliminate Manufacturers or Contractors of similar or equal equipment of the types specified. It should be noted, however, that these requested items are written around specific requirements and needs of the Owner.

The Contractor acknowledges to and for the benefit of the City of Guthrie ("Purchaser") and the Commonwealth of Kentucky (the "State") that it understands the goods and services under this Agreement may be funded with monies made available by the Cleaner Water Program grant funds that could have statutory requirements commonly known as "American Iron and Steel;" that requires all of the iron and steel products used in the project to be produced in the United States ("American Iron and Steel Requirement") including iron and steel products provided by the Contractor pursuant to this Agreement. The Contractor hereby represents and warrants to and for the benefit of the Purchaser and the State that (a) the Contractor has reviewed and understands the American Iron and Steel Requirement, (b) all of the iron and steel products used in the project will be and/or have been produced in the United States in a manner that complies with the American Iron and Steel Requirement, unless a waiver of the requirement is approved, and (c) the Contractor will provide any further verified information, certification or assurance of compliance with this paragraph, or information necessary to support a waiver of the American Iron and Steel Requirement, as may be requested by the Purchaser or the State. Notwithstanding any other provision of this Agreement, any failure to comply with this paragraph by the Contractor shall permit the Purchaser or State to recover as damages against the Contractor any loss, expense, or cost (including without limitation attorney's fees) incurred by the Purchaser or State resulting from any such failure (including without limitation any impairment or loss of funding, whether in whole or in part, from the State or any damages owed to the State by the Purchaser). While the Contractor has no direct contractual privity with the State, as a lender to the Purchaser for the funding of its project, the Purchaser and the Contractor agree that the State is a third-party beneficiary and neither this paragraph (nor any other provision of this Agreement necessary to give this paragraph force or effect) shall be amended or waived without the prior written consent of the State.

The Bidder/Contractor shall submit Manufacturers' Certification letter of compliance with American Iron & Steel Requirement.

If discrepancies or ambiguities are found in the plans, specifications, contract documents or in any communication to the contractor regarding specified materials not compliant with the American Iron and Steel requirement, the contractor shall immediately notify the Engineer in writing.

2.0 CONCRETE

2.1 Cement- Cement shall be Portland cement of a brand approved by the Utility's Engineer and shall conform to "Standard Specifications for Portland Cement", Type 1, ASTM Designation C150, latest revision. Cement shall be furnished in undamaged 94 pound, one cubic foot sacks, and shall show no evidence of lumping.

2.2 Concrete Fine Aggregate- Fine aggregate shall be clean, hard uncoated natural sand conforming to ASTM Designation C33, latest revision, "Standard Specifications for Concrete Aggregate".

- 2.3 Concrete Coarse Aggregate- Coarse aggregate shall consist of clean, hard, dense particles of stone or gravel conforming to ASTM Designation C33, latest revision, "Standard Specifications for Concrete Aggregate". Aggregate shall be well graded between 1-1/2" and #4 sieve sizes.
- 2.4 Water- Water used in mixing concrete shall be clean and free from organic matter, pollutants and other foreign materials.
- 2.5 Ready Mix Concrete- Ready-mix concrete shall be secured only from a source approved by the Utility's Engineer, and shall conform to ASTM Designation C94, latest revision, "Specifications for Ready-Mix Concrete". Before any concrete is delivered to the job site, the supplier must furnish a statement of the proportions of cement, fine aggregate and coarse aggregate to be used for each mix ordered, and must receive the Utility Engineer's approval of such proportions.
- 2.6 Class "A" Concrete- Class "A" concrete shall have a minimum compressive strength of 4000 pounds per square inch in 28 days and shall contain not less than 6 sacks of cement per cubic yard. Class A concrete shall be air-entrained.
- 2.7 Class "B" Concrete- Class "B" concrete shall have a minimum compressive strength of 2000 pounds per square inch in 28 days and shall contain no less than 4 sacks of cement per cubic yard.
- 2.8 Metal Reinforcing- Reinforcing bars shall be intermediate grade steel conforming to ASTM Designation A615, latest revision "Standard Specifications for Billet Steel Bars for Concrete Reinforcement". Bars shall be deformed with a cross sectional area at all points equal to that of plain bars of equal nominal size.

3.0 CRUSHED STONE

Crushed stone for pipe bedding and/or backfill shall meet the quality requirements of ASTM D692 and the grading requirements referenced on the plans.

4.0 WATER PIPE

4.1 PVC Water Pipe (if applicable)

PVC pipe for water shall be manufactured in accordance with ASTM D2241 and have NSF approval. The pipe shall be Class 200 polyvinyl chloride plastic (PVC 1120) SDR-21. The following tests shall be run for each machine on each size and type of pipe being produced, as specified below:

Flattening Test: Once per shift in accordance with ASTM D2412. Upon completion of the test, the specimen shall not be split, cracked or broken.

Acetone Test (Extrusion Quality Test): Once per shift in accordance with ASTM D2152. There shall be no flaking, peeling, cracking, or visible deterioration on the inside or outside surface after completion of the tests.

Quick Burst Test: Once per 24 hours in accordance with ASTM 5199.

<u>SDR</u>	<u>Pressure Rating</u>	<u>Minimum Bursting Pressure, PSI</u>
21	200	800

Impact Tests: 6" and smaller, once each 2 hours in accordance with ASTM D2444.

Wall Thickness and Outside Dimensions Test: Once per hour in accordance with ASTM D2122.

Bell Dimensions Test: Once per hour in accordance with ASTM D3139.

If any specimen fails to meet any of the above mentioned tests, all pipe of that sized and type manufactured between the test period must be scrapped and a full set of tests rerun.

Furnish a certificate from the pipe manufacturer stating that he is fully competent to manufacture PVC pipe of uniform texture and strength and in full compliance with these specifications and further stating that the company has manufactured such pipe for a continuous period of at least ten years. In addition the manufacturer's equipment and quality control facilities must be adequate to ensure that each extrusion of pipe is uniform in texture, dimensions, and strength. Also furnish a certificate from the manufacturer certifying that the pipe furnished for this project meets the requirements of these Specifications.

All pipe shall be manufactured in the United States of America. All pipe for any one project shall be made by the same manufacturer.

The pipe shall be furnished in laying lengths of 20'. The Contractor's methods of storing and handling the pipe shall be approved by the Utility's Engineer. Pipe shall be fully supported as recommended by the manufacturer. Stringing pipe along the proposed route in excess of one day's work will not be allowed.

Certain information shall be marked on each piece of pipe. At the least, this shall consist of:

Nominal Size
Type of material
SDR or class
Manufacturer
NSF Seal of Approval

Pipe that fails to comply with the requirements set forth in these Specifications shall be rejected.

4.2 AWWA C900 PVC Water Pipe (if applicable)

AWWA C900 PVC pipe shall be manufactured from compounds conforming to PVC cell classification of 12454 as defined in ASTM D-1784. The pipe shall meet the requirements of the AWWA C-900-07 standard specification for polyvinyl chloride water distribution pipe. The integral bell joint system shall meet the requirements of ASTM D-3139 and utilize an elastomeric seal conforming to ASTM F-477. AWWA C-900 Pressure Pipe shall carry the NSF Standard 61, the Underwriters Laboratories Inc Standard 1285, and the Factory Mutual Research Water Distribution Pipe for Underground Fire Protection Service marks of acceptance.

The pipe shall be polyvinyl chloride plastic (PVC) DR-18. The following tests shall be run for each machine on each size and type of pipe being produced, as specified below:

Hydrostatic Proof Testing: Each standard and random length of C900 shall be tested to four times the pressure class of the pipe for a minimum of five seconds. The integral bell shall be tested with the pipe.

Quick Burst Test: Once per 24 hours in accordance with ASTM 5199.

<u>DR</u>	<u>Pressure Rating</u>	<u>Minimum Bursting Pressure, PSI</u>
18	235	755

Falling Weight Impact Tests: C900 pipe shall withstand an impact energy of 100 ft-lbs, per the requirements of UL 1285.

If any specimen fails to meet any of the above mentioned tests, all pipe of that sized and type manufactured between the test period must be scrapped and a full set of tests rerun.

Furnish a certificate from the pipe manufacturer stating that he is fully competent to manufacture AWWA C900 PVC pipe of uniform texture and strength and in full compliance with these specifications and further stating that the company has manufactured such pipe for a continuous period of at least ten years. In addition the manufacturer's equipment and quality control facilities must be adequate to ensure that each extrusion of pipe is uniform in texture, dimensions, and strength. Also furnish a certificate from the manufacturer certifying that the pipe furnished for this project meets the requirements of these Specifications.

All pipe shall be manufactured in the United States of America. All pipe for any one project shall be made by the same manufacturer.

The pipe shall be furnished in laying lengths of 20'. The Contractor's methods of storing and handling the pipe shall be approved by the Engineer. Pipe shall be fully supported as recommended by the manufacturer. Stringing pipe along the proposed route in excess of one day's work will not be allowed.

Certain information shall be marked on each piece of pipe. At the least, this shall consist of:

Nominal Size
Type of material
DR or class
Manufacturer
NSF Seal of Approval

Pipe that fails to comply with the requirements set forth in these Specifications shall be rejected.

4.3 Ductile Iron Water Pipe (if applicable)

Ductile iron pipe shall meet the requirements of ANSI/AWWA C150/A21.50 and ANSI/AWWA C151/A21.51 and shall be NSF approved. All ductile iron pipe shall have a minimum pressure rating as specified on the Drawings. All ductile iron pipe shall be cement lined with an asphalt coating on the exterior of the line. In standard buried installation, ductile iron pipe shall be supplied with push-on type joints with SBR rubber, or other gasket material suitable for continuous service in a buried potable water pipeline. Pipe which will be exposed (e.g. above grade, or in vaults or buildings) shall have flanged joints. Pipe size, pressure class, NSF seal, and manufacturer's name shall be clearly marked on the exterior of each pipe joint.

All ductile iron pipe shall have Underwriter's Laboratories, Inc. approval and shall be approved by the National Sanitation Foundation for potable water use. All ductile iron pipe and fittings shall be manufactured in the United States. All pipe for any one project shall be made by the same manufacturer.

Restrained joint pipe and fittings shall meet all other requirements for ductile iron pipe and fittings set forth above, plus having a positive means of restraining the pipeline joint against separation due to internal pressure. All areas specifically designated for restrained ductile iron pipe (i.e. bends, steep slopes or bores) shall be done utilizing regular ductile iron pipe equipped with restraining gaskets. The gaskets shall be equivalent to the American Fast-Grip restrained joint gaskets product.

5.0 FITTINGS (if applicable)

All fittings shall be cast gray iron or ductile iron, cement lined, bituminous coated, manufactured in accordance with AWWA/ANSI Standards A21.10 and A21.11, latest revision, unless otherwise indicated or directed. Minimum pressure rating shall be 250 psi. Unless indicated otherwise on the Drawings, mechanical joint fittings shall be used.

6.0 RESILIENT SEAT GATE VALVES (if applicable)

Gate valves shall be iron body, resilient rubber seat type valves with non-rising stems. Three inch and smaller valves may be bronze body. Resilient seat gate valves shall have a bronze stem nut cast integrally with the cast iron valve disc. The valve shall be capable of being installed and operated in either direction and shall be furnished with mechanical joint ends. Valves shall be suitable for installation

in an approximately vertical position in buried pipe lines. Stem seal shall consist of O-ring seals. All valves shall open to the left (counter-clockwise), and shall be provided with 2" square operating nut. All underground gate valves which have nuts deeper than 30' below the valve box top shall have extended stems with nuts located within one foot of the valve box cap.

Valves shall be for working pressures up to 250 psi and shall be equal to latest specifications of AWWA C-509 in all respects. Valves shall be equal to M&H 4067 or Mueller A-2360. All components shall be manufactured in the United States of America.

7.0 PRESSURE REDUCING VALVES

Individual pressure reducing valves (where presently utilized at a respective location) shall be replaced with a brass body, direct operating valve with screwed connections, suitable for reducing a varying upstream pressure to an adjustable, constant downstream pressure. Pressure reducing valves shall be designed for potable water use, lead free, and shall be Watts ¾" N-250 PRV or approved equal.

8.0 TAPPING SLEEVES AND VALVES (if applicable)

Tapping sleeves shall consist of a mechanical joint, stainless steel tapping sleeve equal to Ford FAST. Tapping valves shall conform to all applicable specifications for resilient seat gate valves. All components shall be manufactured in the United States of America.

9.0 VALVE BOX FRAMES AND COVERS (if applicable)

Valves box frames and covers shall be made of heavy cast iron and shall meet the requirements of ASTM A-48, class 30, and shall be three-piece, 5 1/4" diameter barrel, screw type construction.

All casting shall be made accurately to the required dimensions and shall be sound, smooth, clear and free of blemished or other defects. Defective castings which have been plugged or otherwise treated to remedy defects shall be rejected. Contact surfaces of frames and covers are to be machined so that they rest securely in the frames with no rocking. The cover shall be in contact with the frame for the entire perimeter.

The valve box frames and covers shall be Tyler Union 6850 Series or approved equal. The Cover shall be marked "Water".

10.0 SERVICE CLAMPS AND CORPORATION STOPS

Some service taps in the distribution system **may** require replacement as part of this project.

New service clamps, where needed, shall be used for all new taps made to the water line, and the service clamps and accessories shall be lead free. Service clamps shall be all bronze construction with neoprene gasket, equal to Ford S70 Series. Corporation stops shall include a quick nut assembly, the corporation stop shall be Ford F1000-3G-NL Grip Joint or approved equal and the pack joint coupling shall be Ford C44-33-G-NL or approved equal. Swivels and Inserts or Stiffeners shall be equipped to the corporation stops for added protection of the water service tubing with the use of compression fittings. Swivels shall be Ford L 104-33S for CTS plastic.

11.0 STEEL CASING PIPE (if applicable)

Where noted on the Drawings or required by these Specifications, roadway crossings shall be made utilizing carrier pipe within a casing pipe. Sizes of carrier pipe and casing pipe shall be as noted on the Drawings.

Casing joints shall be of fully welded, leak proof construction. The steel casing pipe shall have a minimum yield strength of 35,000 psi and shall have the minimum wall thickness of 0.25 inches for 12" nominal diameter and smaller pipe. Casing pipe larger than 12" shall have a wall thickness corresponding to ASTM standards for Standard Weight steel pipe. **Steel casing pipe shall be coal tar**

protected according to AWWA Standard C203-91 and C209-20. Pipe shall be welded according to AWWA Standard C206-91 unless otherwise specified.

12.0 PIPELINE DETECTION WIRE

Pipeline detection wire shall be No. 12 solid copper insulated wire. The wire shall be attached to the top of the installed pipe with duct tape prior to backfilling, and the detection wire shall be spliced to seal out moisture. The splicing kit shall be or equal to 3M direct Bury Splice Kit (DBY). Completed sections of detection wire shall be periodically checked for continuity by the Contractor. The Contractor is responsible for the continuity of the wire sections, and shall take measures during construction to insure a working final product. If, upon completion of the continuity test, a section of wire fails, the Contractor shall make corrective measures and the test will be repeated until satisfactory results are obtained.

Precast concrete valve rings, with an embedded copper locator pin, will serve as a wire terminal point for testing and locating.

13.0 WATER SERVICE TUBING

Some sections of water service tubing in the distribution system may require replacement as part of this project.

Service line pipe shall be crosslinked polyethylene (PEXa) municipal water service pipe equal to Municipex, suitable for 200 psi working pressure and meeting AWWA Standard C904.. Detection wire as described above shall be attached to all far side service tubing connections. The wire shall begin at the meter box and terminate at the corporation stop with a water tight wire cap. The water service tubing shall be equipped with inserts or stiffeners do protect the tubing when utilizing compression fittings.

Service lines, where applicable, from the water meter to the customer reconnection point shall be ¾-inch Schedule 40 PVC pipe with solvent weld joints (glued), suitable for a minimum of 200 psi working pressure.

14.0 LARGE FIRE HYDRANT (if applicable)

Large Fire Hydrants, where specified, shall be 4" nominal diameter with 4 1/2" NST outlet. Hydrants shall be M&H Model 129 or approved equal. All components shall be manufactured in the United States of America.

15.0 WATER METERS AND SETTERS

All water meters for the project will be supplied in accordance with specifications detailed in Technical Specification 02-201 ("Automated Water Meter Reading System").

Some water meter sets in the distribution system may require replacement as part of this project.

A. 5/8"x3/4" Meter Installations/Reinstallations:

Replaced meter sets, where requested, shall be 5/8" x 3/4" for residential applications equal to the City of Guthrie's current standard practices. The meter setter shall include a dual check valve, ball valve, and grip nut. The setter shall be Ford VBHH-72-7W-41-33-NL or equal. In cases where a tandem setter is required the setter shall be Ford TVBHH-72-7W-41-33-NL or equal. All meter setters shall be "copper tube size", and all setters and other specified components shall be lead free. For tandem setter installations, the Owner requires that the Idler Bar, or at least the 'S' bar, be included with the typical tandem meter yoke.

B. 1-inch Meter Installations/Reinstallations:

Replaced meter sets, where requested, shall be 1-inch for residential applications equal to the City of Guthrie's current standard practices. The meter setter shall include a dual check valve, ball valve, and grip nut. The setter shall be Ford VBHH-72-7W-41-43-NL or equal. In cases where a tandem setter

is required the setter shall be Ford TVBHH-72-7W-41-43-NL or equal. All meter setters shall be "copper tube size", and all setters and other specified components shall be lead free. For tandem setter installations, the Owner requires that the Idler Bar, or at least the 'S' bar, be included with the typical tandem meter yoke.

C. 2-inch Meter Installations/Reinstallations:

Replaced larger meter sets, where requested, shall be flanged connections and equal to the City of Guthrie's current standard installation practices.

16.0 CASING END SEALS & SPACERS (if applicable)

Casing end seals shall be heavy-duty rubber seals (Model ESW) as manufactured by CCI Pipeline Systems or approved equal. Casing Spacers shall be of heavy-duty two-piece stainless steel as manufactured by CCI Pipeline Systems (Model CSS-center restrained) or approved equal.

17.0 METER BOXES

Some water meter boxes in the distribution system may require replacement as part of this project.

A. 5/8"x3/4" Meter Installations/Reinstallations:

Meter boxes for 5/8"x3/4" setters shall be 18" in diameter x 24" in depth with cast iron lids. Meter boxes shall be green, ribbed or approved equal. The round metal lids shall be 18" in diameter with outer ring and a flat center surface. The lids may (pending the type of radio-read meter provided) require a 2" hole predrilled to allow for the particular automated meter reading system to be installed, and the contractor shall provide and install a 'Thru Lid Install Kit' (matched to respective meter/radio manufacturer). Meter boxes shall be manufactured by Hancor or approved equal. The Lids shall be Vestal (model WM-18) or approved equal.

B. 1-inch Meter Installations/Reinstallations:

Meter boxes for 1-inch setters shall be rectangle, 33" (L) x 20" (W) x 18" (H) minimum with ductile iron covers. Meter boxes shall be black or approved equal. The rectangle heavy duty ductile iron covers shall be flat and marked for "Water Meter". The lids may (pending the type of radio-read meter provided) require a 2" hole predrilled to allow for the particular automated meter reading system to be installed, and the contractor shall provide and install a 'Thru Lid Install Kit' (matched to respective meter/radio manufacturer). Meter boxes shall be manufactured by Carson (Oldcastle; model 1730BCF) or approved equal. The Lids shall be Sigma (model LC 1730-D) or approved equal.

C. 2-inch Meter Installations/Reinstallations:

Meter boxes for 2-inch inline meters shall be 36"x36" Black & White poly box with a 36"x18" extension ring to accommodate an 18" diameter round metal lid. The top round metal lid shall be 18" in diameter with outer ring and a flat center surface. The lids may (pending the type of radio-read meter provided) require a 2" hole predrilled to allow for the particular automated meter reading system to be installed, and the contractor shall provide and install a 'Thru Lid Install Kit' (matched to respective meter/radio manufacturer). The Lids shall be Vestal (model WM-18) or approved equal.

D. 3-inch & Larger Meter Installations/Reinstallations:

Meter boxes for 3-inch & Larger inline meters shall be a 48"x48"x48" precast vault with a drop in hatch where the angle frame of the hatch slips down in the inside perimeter of the vault allowing for easy removal and access. Both the vault and hatch shall be traffic rated. The bottomless vault should straddle the water main with doghouse openings to accommodate the respective pipe size and easily slip over the existing water main without disassembly. The traffic-rated hatch should be 36"x36" at a minimum in size. The hatch may require a 2" hole predrilled to allow for the particular automated meter reading system installed, and the contractor shall provide and install a 'Thru Lid

Install Kit' (matched to respective meter/radio manufacturer). The vault shall be iCast 4'Wx4'Lx4'H Meter Vault or approved vault.

18.0 PRECAST VALVE BOXES & OTHER ITEMS

Precast concrete valve rings shall be 24-inches in diameter and 4-inches thick. Each ring shall be equipped with an embedded copper locator test pin, which will serve as a detection wire terminal point for locating nonmetallic pipelines.

Precast concrete items shall meet all requirements of ASTM C478. All concrete used in precast items shall have a compressive strength of at least 4,500 psi at 28 days

END OF SECTION 02-200

AUTOMATED WATER METER READING SYSTEM

1.0 GENERAL

Under this specification, all equipment, software, services and accessories to furnish an automated water meter reading system {drive-by, radio-based capable water meters **OR** fixed based read (cellular or radio) capable water meters} shall be supplied by a single vendor for installation by the Owner, the Vendor or his subcontractor. The system shall be designed to provide accurate meter reading data for customer billing purposes, and usage data to facilitate enhanced operation and management of the water distribution system.

The Bidder's proposal shall provide a detailed description of each component of the system offered, along with unit bid prices for each item. As a minimum, the Bidder shall:

- A. Provide a unit price Bid, using the quantities specified in the bid form for supplying the specified number of new meters and the automated system equipment, including all hardware, software and services.
- B. Provide supplemental bid prices as specified in the bid form.
- C. Provide a minimum of five (5) references with those references being similar municipalities or rural water utilities currently using the Bidder's proposed metering system. The reference information shall include contact names, addresses, and telephone numbers, along with a general description of the application.
- D. Provide the name and phone number of the service technician and meter supplier representative identified to provide service to the Utility for the Bidder's proposed metering system.
- E. Provide both a technical and layman's explanation of all the components and features proposed within the manufacturer's system including range of transmission, provisions for transmitting in flooded situations, reading collection devices, leak detection features, and error detection.

1.1 Scope of Work

The Equipment portion of the Work shall consist, but not limited to, the following items:

- A. Items to be included in **BASE BID EQUIPMENT** Pricing
 - a. Provide seven hundred sixty-five (765) new 5/8x3/4-Inch regular water meters (electromagnetic or ultrasonic; solid state), all with drive-by read capability.
 - b. Provide up to twenty (20) new 1-Inch regular water meters (electromagnetic or ultrasonic; solid state), all with drive-by read capability.
 - c. Provide up to eight (8) new 2-Inch regular water meters (electromagnetic or ultrasonic; solid state), all with drive-by read capability.
 - d. Provide one (1) new 4-Inch water meter (electromagnetic or ultrasonic; solid state), all with drive-by read capability.
 - e. Provide one (1) new 6-inch water meter (electromagnetic or ultrasonic; solid state), all with drive-by read capability.
 - f. Provide seven hundred ninety-five (795) new Individual Transceiver Units, if applicable, for all new meters to communicate and provide the drive-by read capability. Each Unit shall be accompanied with the manufacturer's 'thru-the-lid' kits for mounting under the meter lid.

- g. Provide all hardware, software, equipment and accessories for a fully functional radio-read meter system, all of which is compatible with the Utility's present billing and operational systems. Provide one (1) new notebook computer or tablet with vehicle mounting brackets which may be utilized to collect the meter reading information. Provide at least one (1) handheld units, including appropriate docking stations.
 - h. Provide all software integration, system start-up and training services as specified.
 - i. Provide all required warranties on meter transmitters as specified. Additionally, provide information on manufacturer's standard warranty related to the meter accuracy itself.
 - j. Provide an estimate for any reoccurring costs to be associated with the drive-by read system.
- B. Items to be included in Supplemental **BASE BID EQUIPMENT** Prices
- a. Provide new 1½-inch water meters (electromagnetic or ultrasonic; solid state) with drive-by read capability.
- C. Items to be included in **ALTERNATE BID EQUIPMENT** Price
- a. Provide seven hundred sixty-five (765) new 5/8x3/4-Inch regular water meters (electromagnetic or ultrasonic; solid state), all with fixed based read capability.
 - b. Provide up to twenty (20) new 1-Inch regular water meters (electromagnetic or ultrasonic; solid state), all with fixed based read capability.
 - c. Provide up to eight (8) new 2-Inch regular water meters (electromagnetic or ultrasonic; solid state), all with fixed based read capability.
 - d. Provide one (1) new 4-Inch water meter (electromagnetic or ultrasonic; solid state), with fixed based read capability.
 - e. Provide one (1) new 6-inch water meter (electromagnetic or ultrasonic; solid state), with fixed based read capability.
 - f. Provide seven hundred ninety-five (795) new Individual Transceiver Units, if applicable, for all new meters to communicate and provide the fixed based read capability, either by Radio Communication or Cellular Communication. Each Unit shall be accompanied with the manufacturer's 'thru-the-lid' kit for mounting under the meter lid.
 - g. Provide all hardware, software, equipment and accessories for a fully functional fixed based read meter system (utilizing cellular or radio communications), all of which is compatible with the Utility's present billing and operational systems. Provide one (1) new notebook computer or tablet with vehicle mounting brackets which may be utilized to collect the meter reading information. Provide at least one (1) handheld units, including appropriate docking stations.
 - h. Provide all software integration, system start-up and training services as specified.
 - i. Provide all required warranties on meter transmitters as specified. Additionally, provide information on manufacturer's standard warranty related to the meter accuracy itself.
 - j. Provide an estimate for any reoccurring costs to be associated with the fixed based system.
- D. Items to be included in Supplemental **ALTERNATE BID EQUIPMENT** Prices
- a. Provide new 1½-inch water meters (electromagnetic or ultrasonic; solid state) with fixed based read capability.

1.2 Description of the Water Distribution System

The Guthrie municipal water system serves approximately 795 customers within and adjacent to the corporate limits of Guthrie, Kentucky. The system currently uses manual and/or drive-by read water meters of differing brands and ages.

The approximate current inventory of meters is as follows:

5/8x3/4-Inch Meters	765
1-Inch Meters	15 to 20
2-Inch Meters	6 to 8
4-Inch Meters	1
6-Inch Meters	1

The Guthrie Water Works system anticipates continuing use of its current billing software after the installation of the automated read meter system. The new meter manufacturer shall contact the water system to insure the Bidder's compatibility all such software. The current software utilized with by the utility is as follows:

Billing Software: UB Max
Sale Rep = Doug Davis (dougd@softlinedata.com)
800.657.0880

1.3 Meter Performance Requirements:

The automated-read meter system will utilize an FCC non-licensed frequency to communicate meter-reading data, tamper conditions, and leak detection notification to a receiver. The system shall be comprised of a transmitter located at the meter that transmits readings, tamper and leak data to the receiver when the receiver is in the proximity range of the transmitted signal. As an option, the transmitter may also contain data profiling capabilities. The transmitter with data profiling capabilities will have sufficient memory to store multiple readings with tamper detection and potential leak information that can be downloaded and graphed in an analysis software program. The system shall be able to process and maintain the information gathered from each transmitter in a database for billing purposes.

In combination with transmitters located at the meter, the automated-read meter system must be able to read the utility's meters. Minimum performance requirements for the new Water Meters are as follows:

- A. Meter Reading: The transmitter shall transmit readings with an optimal number of intervals in accordance with the manufacturer's normal performance.
- B. High Resolution – To provide useful consumption data, the automated-read meter system shall record usage through the meter to the closest one (1) gallon {US Gallon} increment on residential size meters (5/8" through 2"). For larger meters, usage shall be recorded to the nearest ten (10) gallons.
- C. Leak Detection – To assist in the timely identification of potential leaks, the transmitter shall have an option to report information to the utility in regards to potential leaks.
- D. Tampering – The transmitter shall detect and report any suspected evidence of meter tampering.
- E. Data Logging/Profiling – The transmitter shall also contain data profiling capabilities. The transmitter with data profiling capabilities will have sufficient memory to store multiple readings with tamper detection and potential leak information that can be downloaded and graphed in an analysis software program. The system shall be able to process and maintain the information gathered from each transmitter in a database for billing purposes.
- F. Operating Pressure - Meters should have a minimum operating pressure of 250 psi.

- G. Flow Ranges & Accuracy - Meters should meet or exceed the most recent version of ANSI/AWWA Standard C-700, C-708 & C-715 for flow ranges, accuracy, and pressure loss requirements.

1.4 Hardware Requirements

- A. Water meters are to be:
 - a. Electromagnetic or ultrasonic type; solid state “no moving parts” technology is preferred
 - b. 5/8”x3/4” for typical residential applications, meeting the requirements of AWWA C-708, most recent edition.
 - c. Meters should contain NO Lead, not just NSF61 approved low lead.
 - d. Meters shall be provided with a metal case and bottom, and externally threaded metal connections. Plastic connections are not desired. **(Bidders shall list any exceptions otherwise)**.
 - e. Meters shall utilize an encoder register and mobile AMR register compatible with the reading system proposed. The radio system shall be contained internally within the meter box, and the manufacturer shall provide all accessories (i.e. lid mount, wires, antenna, etc) for each meter to transmit a signal be received further.
- B. Mobile Reading System for Radio-Read System: The radio-read system shall consist of a ruggedized tablet or laptop computer (with 14” display suitable for outdoor use in direct sunlight conditions, spill- resistant keypad, multiple USB ports, wi-fi & Bluetooth enabled, and Windows 10 Pro operating system) and a truck mounted meter signal receiver. The tablet &/or laptop computer shall be Panasonic Toughbook CF-33, Panasonic FZ-G2 Tablet, or approved equals. Capabilities include reading up to 5,000 meters per minute limited only by travel speed and meter installation density. The Reading System shall be portable and adaptable to any vehicle with a 12VDC power supply. The Reading System shall include backup memory for previously read meters. **Bidders shall list any exceptions within their bid detailing alternate options to their proposed reading device.**
- C. Mobile Reading System Upload/Download: Meter readings (routes) shall be transferred between the reading system and the utility’s computer by use of wi-fi connection (primary), and USB memory stick or by directly networking the system laptop into the utility’s networked system (secondary).
- D. Mobile Meter Reading: The meter transmitter sends data to the Reading System including: ID number, meter reading, and tamper/leak status.

1.5 Software Requirements

The reading software shall be a Geographic Information System (GIS) based meter reading system. The version shall have the capability of using a GIS system for displaying meter reading information on a MAP program, and the version shall have the capability of using Global Positioning System (GPS) to display the location of the vehicle reading the meters on the MAP program. The City will provide mailing address data on water meters for use by the equipment supplier in setting up the meter reading system.

Leak detection shall be available with the software. The transmitter sends an alarm condition to the meter reading software when the meter is read. The system shall report a leak condition based on parameters set-up by the Utility’s management during start-up.

Route management software shall be provided which allows transfer of route information from the reading system to the utility computer. Software shall provide splitting, re-sequence and combining of routes. Management reports shall include meter reading, exception and productivity information along with standard and customized reporting features. An interface program must be written, if warranted, to allow the billing software and the route management software to communicate with each other. Appropriate documentation regarding interface requirements must be supplied to the billing vendor (See Paragraph 1.2). The successful bidder must provide assistance to the utility in order to complete the interface program.

1.6 FCC Requirements & Communication Parameters

All transmitters and receivers shall operate as a non-licensed system and be certified by the manufacturer. The transmitter shall operate at a frequency requiring only FCC certification but no customer license.

1.7 Installation, Training, Tools & Product Support

The manufacturer's certified training personnel shall set up and test the Automated-Read Meter System and related software at the utility location. Upon successful completion of the set-up, the manufacturer's certified training personnel shall provide a minimum of two (2) days training at the utility site on the operation and maintenance of the system. Training shall include training of field technicians on the installation of field transmitters. Initial configuration and initial test are the complete responsibility of the successful bidder.

Phone support for the system shall be provided free of charge during the warranty period. Manufacturer shall provide continued support of the Automated-Read Meter System after completion of training. Technical support shall be available 24 hours a day, 365 day a year.

2.0 MATERIAL AND EQUIPMENT

The Contractor acknowledges to and for the benefit of the City of Guthrie ("Purchaser") and the Commonwealth of Kentucky (the "State") that it understands the goods and services under this Agreement may be funded with monies made available by the Cleaner Water Program grant funds that could have statutory requirements commonly known as "American Iron and Steel;" that requires all of the iron and steel products used in the project to be produced in the United States ("American Iron and Steel Requirement") including iron and steel products provided by the Contactor pursuant to this Agreement. The Contractor hereby represents and warrants to and for the benefit of the Purchaser and the State that (a) the Contractor has reviewed and understands the American Iron and Steel Requirement, (b) all of the iron and steel products used in the project will be and/or have been produced in the United States in a manner that complies with the American Iron and Steel Requirement, unless a waiver of the requirement is approved, and (c) the Contractor will provide any further verified information, certification or assurance of compliance with this paragraph, or information necessary to support a waiver of the American Iron and Steel Requirement, as may be requested by the Purchaser or the State. Notwithstanding any other provision of this Agreement, any failure to comply with this paragraph by the Contractor shall permit the Purchaser or State to recover as damages against the Contractor any loss, expense, or cost (including without limitation attorney's fees) incurred by the Purchaser or State resulting from any such failure (including without limitation any impairment or loss of funding, whether in whole or in part, from the State or any damages owed to the State by the Purchaser). While the Contractor has no direct contractual privity with the State, as a lender to the Purchaser for the funding of its project, the Purchaser and the Contractor agree that the State is a third-party beneficiary and neither this paragraph (nor any other provision of this Agreement necessary to give this paragraph force or effect) shall be amended or waived without the prior written consent of the State.

Materials, products and equipment shall be properly containerized, packaged, boxed and protected to prevent damage during transportation and handling. Provide suitable temporary weather tight storage facilities as may be required for materials or equipment which will be damaged by storage in the open. Protect from damage all materials delivered at the site.

Manufactured articles, materials and equipment shall be applied, installed, connected, erected, used, cleaned and conditioned as directed by the respective manufacturers unless directed otherwise by the provisions of these Specifications.

3.0 SUBMITTALS

Provide at least four copies of each submittal, and allow two weeks for Engineer's review. Such submittals are to be approved by Engineer prior to incorporation of any materials into the work.

4.0 WARRANTIES

Meters should have a 10 year full plus 10 year prorated warranty, including any batteries. It is preferred that meter warranties start upon delivery to the project site.

Meter transmitters should have a 10 year full plus 10 year prorated warranty, including any batteries. The warranty shall include repair or replacement without cost to the Owner of any component of the system failing as a result of manufacturer's defect during the warranty period.

All handheld and mobile reading equipment (i.e. Toughbook laptop or tablet) included with the Automated Reading System shall include an original manufacturer's warranty, along with a hardware service contract on all hardware components of the system from delivery through **June 30, 2025**. Software supplied with the system shall be updated and maintained by the manufacturer guaranteed for compatibility with all other components of the system through **June 30, 2025**.

The warranty shall include repair or replacement without cost to the Owner of any component of the system failing as a result of manufacturer's defect during the warranty period.

END OF SECTION 02-201

WATER MAIN CONSTRUCTION

1.0 PRELIMINARY WORK

1.1 Engineer

All references to "Engineer" in this specification refers to the Utility's Engineer.

1.2 Location of Lines

The Contractor shall install the proposed lines and/or appurtenances in the locations indicated on the plans, except where field conditions are encountered which warrant relocation. Any field relocation of the pipelines and/or appurtenances shall be approved by the Engineer's Representative at the time of construction. In no event shall any improvements be installed outside of properties, easements or right-of-way secured by the Owner for the Project.

1.3 Locations and Protection of Underground Utilities

Prior to trenching, excavating, or disturbing the ground surface in any manner, the Contractor shall determine, insofar as possible, the actual location of all underground utilities in the vicinity of the proposed construction and shall clearly mark their locations so that they may be avoided by equipment operators. Where such utility lines appear to lie in the path of construction, they shall be uncovered in advance to determine the exact location and depth, and to avoid damage due to Contractor's operations. Existing facilities shall be protected during construction, or removed and replaced in equal condition as necessary.

Should any existing utility line or service be damaged during, or as a result of the Contractor's operations, the Contractor shall take such emergency measures as may be necessary to minimize damage and shall immediately notify the utility involved. The Contractor shall then repair the damage to the satisfaction of the utility or shall pay the utility for making the repairs. In all cases, the restoration or repair shall be such that the repaired item will be in as good or better condition as before the damage occurred.

1.4 Removal of Obstructions

The Contractor shall be responsible for the removal, safeguarding and replacement of fences, walls, structures, culverts, street signs, billboards, shrubs, mailboxes, or other obstructions which must be moved to facilitate construction. Such obstructions must be restored to at least their original condition.

1.5 Clearing and Grubbing

The contractor shall be responsible for cutting, removing and disposing of all trees, brush, stumps, roots, and weeds within the construction area. Disposal shall be by means of chippers, landfills, or other approved methods not in conflict with State or local ordinances.

Avoid cutting or damage to trees not in the construction area. The Contractor will be responsible for the replacement of trees, shrubs, etc. unnecessarily damaged or removed.

1.6 Crops and Livestock

Any agricultural crop or product, or any livestock that is injured, damaged, lost or destroyed by the construction operations shall be the responsibility of the Contractor. The Contractor shall take precautions to avoid or minimize such damage, and shall compensate the owner of the crop or livestock for any loss that may result from construction operations.

2.0 EXCAVATION

2.1 General

The Contractor shall perform all required excavation and backfilling incidental to the installation of the water line, valves, services, and other appurtenances under this contract. Excavation shall be carried to the depths indicated on the Drawings or as necessary to permit the proper installation of pipe, bedding, structures or appurtenances. Care shall be taken to provide a firm, undisturbed, uniform surface in the bottoms of trenches and excavations. Where the excavation exceeds the required depth, the Contractor shall bring the excavation to proper grade through the use of an approved incompressible backfill material (generally crushed stone or fill concrete, depending upon the nature of the item to be placed thereon). In the event that unstable soil conditions are encountered at the bottom of the excavation, the Engineer may direct the Contractor to continue the excavation to firm soil, or to provide a suitable special foundation.

The Contractor shall take such precautions as may be necessary to avoid endangering personnel, pavement, adjacent utilities or structures, etc. through cave-ins, slides, settlement or other soil disturbance resulting from his operations.

The Contractor shall be responsible for storage of excavated materials, disposal of surplus excavated material, trench dewatering and other and other operations incidental to excavation and backfilling operations.

2.2 Trenching and Excavation Safety

The Contractor shall be responsible for safe trenching and excavating operations. The Contractor's responsibilities in this regard include complying with all OSHA requirements regarding trench and excavation safety, providing a person knowledgeable in excavation operations and safety (a Competent Person as defined by OSHA) to supervise all trenching and excavation activities, providing all required equipment and supplies to safely complete the work, continuously monitor soil conditions and make adjustments in the trenching and excavation methods (e.g. lay back trench sides, provide shoring, etc.) where necessary to provide for safe working conditions, guarding or barricading open trenches and excavations, and other considerations to insure safety. Providing for the safety of the workers and others in the vicinity of the construction operations takes precedence over all other considerations. Any damage to property, injury or loss of life resulting from trench or excavation failure shall be the sole responsibility of the Contractor.

2.3 Classification of Excavation

Excavation shall be unclassified and the cost of excavation shall be merged into the price per foot for the water main. No distinction will be made between rock and soil excavation, and no claim for additional payment will be considered if based upon the type or character of material encountered.

2.4 Pavement Removal

Where existing paved streets, roads, parking lots, drives or sidewalks must be disturbed during construction of the project, the Contractor shall take the necessary steps to minimize damage. Permanent type pavement shall be sawed in a straight line before removal, and care shall be taken during excavation to avoid damage to adjacent pavement. Where trucks or other heavy equipment must cross curbs or sidewalks, such areas shall be suitably protected.

2.5 Trench Excavation

Trenches shall be excavated in a neat and workmanlike manner, maintaining proper alignment except where necessary to make deviations to miss obstructions. Trenching for the installation of water distribution piping shall be such that the pipe will have a minimum cover of thirty (30) inches. The bottom of the trench must be shaped by hand and bell holes must be dug so that the full length of pipe is resting on sound trench bottom. Blocking shall not be used. In some cases, more than 30 inches of cover will be necessary to cross under existing utilities, obstructions, etc., or where the completed grade will be below

the grade at the time of construction. This additional depth, when required, shall be merged into the unit bid price for water main construction.

Trenches shall be opened far enough in advance of pipe laying to reveal obstructions, but in general shall not include more than 300 feet of continuous open trench at any time. The Contractor will be required to follow up trenching operations promptly with pipe laying, backfill and clean-up, and in the event of failure to do so, may be prohibited from opening additional trench until such work is completed.

The Contractor shall plan his operations so as to cause a minimum of inconvenience to property owners and to traffic. No road, street or alley may be closed unless absolutely necessary, and then only if the following conditions are met:

1. Permit is secured from appropriate State, County or Municipal authorities having jurisdiction.
2. Fire, police and other emergency services providers are notified before the road is closed.
3. Suitable detours are provided and clearly marked.

No driveway shall be cut or blocked without first notifying the occupants of the property. Every effort shall be made to schedule the blocking of drives to suit the occupant's convenience, and in no case shall a driveway be blocked overnight.

The Contractor shall furnish and maintain barricades, signs, flashing lights, and other warning devices as necessary for the protection of public safety. Flagmen shall be provided as required on heavily traveled streets to help avoid traffic jams or accidents.

Trench width shall be held to a minimum consistent with proper working space for the assembly of pipe. Maximum trench width up to a point one foot above the top of pipe shall be limited to the outside diameter of the pipe plus 16". Boulders, large stones, shale and rock shall be removed to provide clearance of 6" below and on each side of the pipe.

Trench walls shall be kept as nearly vertical as possible with due consideration to soil conditions encountered and when necessary, sheeting or bracing shall be provided to protect life and property.

Where unsuitable soil conditions are encountered at the trench bottom, the Contractor shall remove the additional material as may be directed by the Engineer and replace the excavated material with approved backfill.

The Contractor shall excavate by hand wherever necessary to protect existing structures or utilities from damage or to prevent overdepth excavation in the trench subgrade.

Excavated material shall be stored safely away from the edge of the trench and in such a way as to avoid encroachment of private property.

2.6 Excavation for Structures

Excavation for air release valve installations, metering pits or other appurtenances shall be only as large as may be required for the structure or appurtenance, and for working room around it. In soil, excavation shall generally extend to the outer limits of the structure plus working space at the bottom, and shall slope outward as such an angle as may be required to insure stability of the excavated face. In rock, excavation shall be carried to a point at least 12 inches outside the structure, or as required to achieve proper placement of the backfill. No rock shall be placed or left within 12 inches of the finished structure.

Care shall be taken as the excavation approaches the desired grade to avoid overdepth excavation and provide a firm and undisturbed soil surface on which footings, slabs or foundations are to be placed. Should the Contractor excavate below the desired grade level, the excavation shall be brought to grade by the use of fill concrete at the expense of the Contractor. The use of tamped earth refill beneath foundations, footings or slabs will not be acceptable.

Where structures rest partially or completely upon rock, the rock shall be excavated to a point 6 inches below the bottom elevation of the proposed structure, and crushed stone refill shall be used to bring the excavation back to grade.

Should the material found at the desired subgrade appear to be unstable or otherwise unsuitable for support of the structure, the condition shall be immediately called to the attention of the Engineer. The Engineer may direct that the unsuitable material be removed and replaced with concrete, or that the foundation design be modified to accommodate the conditions encountered. In any event, work in the area affected by the unstable subgrade shall not proceed until the matter is resolved by the Engineer.

2.7 Rock Excavation

Where rock excavation is encountered in trenches, the excavation shall be carried to a depth of at least 6 inches below the bottom of the proposed pipe. The rock shall also be removed to a width of at least 6 inches beyond the pipe on each side so that no rock is left within 6 inches of the outside wall of the pipe. Where rock is excavated in the bottom of the trench, the trench shall be brought back to grade by the use of crushed stone which shall be compacted to form a stable base for the pipe laying operation. If approved in advance by the Engineer, clean excavated soil that is free from rocks may be used in lieu of crushed stone as bedding.

The Contractor shall exercise all necessary precautions in blasting operations. Suitable blasting mats shall be provided and utilized as required. Blasting shall be done only by experienced personnel with all required training and certifications. Careless shooting, resulting in the ejection of stones or other debris during blasting shall be corrected immediately by the Contractor. The Contractor shall be responsible for any personal injury or property damage that results his from blasting.

No blasting shall be done unless the Contractor shall have taken out the necessary insurance to fully protect the Owner from all possible damages resulting from the blasting operations. The blasting shall be done in accordance with all recognized safety precautions and in accordance with regulations of authorities having jurisdiction. In addition, the Contractor shall exercise the necessary care to safeguard the stores of blasting materials on the jobsite.

Where rock is encountered in the immediate vicinity of gas mains, telephone cables, building footings, gasoline tanks, or other hazardous areas, the Contractor shall remove the rock in a manner that will insure protection of these structures. Care shall be taken in the blasting operations to see that the pipe or other structures previously installed are not damaged by blasting. In general, blasting shall not be done within 25 feet of an existing pipeline or structure.

2.8 Disposal of Surplus Excavated Material

Excavated material that is unsuitable or unnecessary for backfilling shall be disposed of by the Contractor. Disposal may be by landfill, or other legal means. Where material is disposed of on private property, the Contractor is responsible for obtaining permission in writing from the property owner and for restoration of the disposal site to the property owner's satisfaction.

2.9 Subsurface Obstructions

In excavating, backfilling and laying pipe, do not remove, disturb or damage other pipe, conduit or structures without the approval of the Engineer. If necessary, the Contractor shall sling, shore up and maintain such structures in operation, and within a reasonable time shall repair any damage done thereto. Repairs to these facilities shall be made to the satisfaction of the Engineer.

The Contractor shall give sufficient notice to the interested utility of his intention to remove or disturb any other pipe, conduit, etc., and shall abide by their regulations governing such work. In the event that subsurface items are damaged in the prosecution of the work, the Contractor shall immediately notify the proper authorities and shall be responsible for any loss to persons or property caused by the damage.

When pipes or conduits providing service to adjoining buildings are broken during the progress of the work overnight or for needlessly long periods during the day, will not be tolerated, and the Owner

reserves the right to make repairs at the Contractor's expense without prior notification. Should it become necessary to move the position of a pipe, conduit, or structure, it shall be done by the Contractor in strict accordance with instructions given by the Engineer or the utility involved.

The Owner or Engineer will not be liable for any claim made by the Contractor based on underground obstructions being different than that indicated on the Plans. Where ordered by the Engineer, the Contractor shall uncover subsurface obstructions in advance of construction so that the method of avoiding same may be determined before pipe laying reaches the obstructions.

The Contractor shall be governed by instructions of the Kentucky Transportation Cabinet and/or County Road Department regarding the laying of pipe along and/or within State/County Roadways.

2.10 Special Conditions

Special care must be exercised in excavation under or near State Highways, railroads, or other areas as designated on the Drawings in order to avoid or minimize delays or injuries resulting therefrom. Where it is necessary to cross beneath state highways, railroads, or other designated areas, the Contractor shall make such installations as shown on the Drawings and/or as directed by the Department of Highways or the Railroad.

The Contractor's attention is also called to the special conditions associated with the proximity of the Owner's existing water distribution system in relation to improvements indicated on the Plans. Some of the proposed improvements will be constructed adjacent to and/or may encounter existing water lines that must remain in service until the successful testing and completion of the proposed improvements. The Contractor is reminded of paragraph 2.1 of Section 02-100, and the Contractor is urged to use the most appropriate construction measures to produce a suitable finished product while maintaining the integrity of the existing infrastructure.

3.0 INSTALLATION OF WATER LINE AND APPURTENANCES

3.1 General

The Contractor shall use only experienced men in the final assembly of pipe in the trench,, and all pipe shall be laid in accordance with these Specifications and the recommended practice of the pipe manufacturer. Trench bottoms shall be carefully prepared and shall be free of water.

Care shall be exercised to insure that pipe of the proper strength or classification meeting the specifications in every respect is provided at the site of pipe laying operations. Recommended tools, equipment, lubricant and other accessories needed for proper assembly or installation of the pipe shall be provided at the site of work. Any damaged or defective pipe discovered during the pipe laying operations shall be discarded and removed from the site of the pipe laying operations.

The Contractor shall exercise care in the storage and handling of pipe, both on the storage yard and at the site of laying operations. Suitable clamps, slings, or other lifting devices shall be provided for handling large-diameter pipe and fittings.

Pipe may be assembled at grade and lowered into the trench provided that no more than 10 joints are lowered at one time, and the pipe is inspected after it is lowered into the trench to assure that no decoupling of joints occurs.

Bell holes for bell and spigot and mechanical joint pipe shall be dug in the trench to allow entire length of pipe barrel to be bedded and to allow proper jointing of pipe. Alignment of pipe shall be as true as possible in order to avoid air pockets. When work is suspended either for the night or for any other reason, open ends of the pipe shall be securely plugged to prevent the entrance of foreign materials. Dead ends of the pipe and unused branches of crosses, tees, valves, etc., shall be closed with plugs suitable to the type of pipe in use.

Cutting of pipe shall be done in a neat, workmanlike manner without damage to pipe, coatings and linings and so that a smooth end remains at right angles to the axis of the pipe.

3.2 Removal of Water

The Contractor shall be responsible for handling run-off, ground water, and sewage in such a way as to maintain trenches and excavations in a dry condition until the work is completed. Pumps, piping, well points, labor, fuel, and other facilities necessary to control, intercept, remove and/or dispose of water shall be provided by the Contractor at his own expense. Water removed from trenches or holes shall be discharged to natural drains in such a way as to avoid danger or damage to adjacent property owners or sewers. No Pipe shall be laid with water in the bells.

Where the Contractor fails, refuses, or neglects to control water in trenches or other excavations, and corrective work is deemed by the Engineer to be necessary as a consequence thereof, such work shall be at the Contractor's expense.

3.3 Polyvinyl Chloride Pipe (Class 200 PVC)

Installation of polyvinyl chloride pipe shall conform to ASTM 2321 and AWWA C900, latest revision. Pipe shall be bedded in clean, uniform soil or compacted granular material and compacted granular material to a point 8" over pipe. Blocking shall not be used to bring the pipe to grade. Whenever it is necessary to cut a joint of pipe in order to fit the trench conditions, the cutting may be made with either hand or mechanical saws or plastic pipe cutters. The cut shall be square and perpendicular to the pipe axis. The cut end shall be beveled as specified by the pipe manufacturer. Assemble all joints by fully seating spigot into bell.

3.4 Ductile Iron Pipe

Installation of ductile iron pipe shall conform to AWWA C150 & C151, latest revision. Pipe shall be bedded and backfilled in conformance with the details shown on the Plans. Blocking shall not be used to bring the pipe to grade. The trench shall be backfilled as indicated on the Drawings so as to achieve a Class III laying condition. Whenever it is necessary to cut a joint of pipe in order to fit the trench conditions, the cutting shall be made in a suitable pipe fabrication shop with mechanical saws. The cut shall be square and perpendicular to the pipe axis. The cut end shall be beveled as specified by the pipe manufacturer. Assemble all joints by fully seating spigot into bell, using an approved gasket lubricant.

Restrained joint ductile iron pipe shall be installed in full conformance with the pipe manufacturer's recommendations. Backfill to 12 inches above restrained joint pipe shall be with granular material (crushed limestone aggregate) to assure maximum friction between the pipe wall and backfill. Should soil conditions be encountered that would require restrained joint pipe to be encased in polyethylene for corrosion protection, an increased length of restrained joint pipe may be required. The Contractor shall ascertain the need for polyethylene encasement from the Engineer sufficiently in advance to allow for installation of the appropriate length of restrained joint pipe.

3.5 Installation of Fittings

Fittings in pipe lines shall be firmly secured to prevent the fitting from being blown off the line when under pressure. When connections are made between the new work and existing mains, the connections shall be made using specials and fittings to suit the actual conditions.

All tees, caps, plugs, bends or other fittings subjected to unbalanced forces tending to pull the joints apart shall be protected with concrete thrust blocks. Thrust blocks shall be provided in accordance with details shown on Drawings, and must bear against an undisturbed trench face. Thrust blocks must be used unless written permission is obtained from the engineer to use special locked-joint fittings, anchoring fittings, or pipe clamps with tie rods.

Fittings shall be placed in locations indicated on Drawings or designated by Engineer and shall be installed in accordance with provisions of these Specifications. Joints shall be as designated under Section 2, Materials.

Before being placed in trench, all fittings shall be subjected to inspection by Engineer; and any defective, unsound or damaged fittings shall be rejected and Contractor shall remove at once from work area.

3.6 Installation of Valves, Valve Boxes

Valves shall be placed in the locations indicated on the Plans or at locations designated by the Engineer. All Valves shall be set vertically. Before being placed in the trench, all valves shall be carefully examined by the Contractor and engineer to see that they are in good working order.

Over each valve shall be placed a valve box. All valves which, when properly set, have operating nuts deeper than 24" below the top of the valve box shall have extension stems with operating nuts located within one foot of the valve box cap.

The valve box shall not come in contact with valve at any point. Backfill around boxes shall be tamped to maintain centered and plumbed alignment of box. The finished valve box installation shall allow a standard valve wrench to be seated on the operating nut and removed easily without contacting the valve box.

Box shall be installed with top set flush with finished surface in paved areas and 1 inch above natural ground level in unpaved areas.

4.0 BACKFILL

4.1 General

Backfilling shall be carried out as expeditiously as possible, but shall not be undertaken until the Engineer's representative has been given the opportunity to observe the work. The Contractor must carry out all backfilling operations with due regard to: the protection of pipes, structures and appurtenances; the use of prescribed backfill materials; and procedures to obtain the desired degree of compaction. No equipment may be used which will result in damage to or misalignment of the pipe.

4.2 Acceptable Backfill Material

All backfill material shall be free from cinders, ashes, refuse, vegetable or organic material, boulders, rocks or stones, or other material that in the opinion of the Engineer is unsuitable. From eight inches above the top of the pipe to within six inches of finished grade in unpaved areas, backfill may contain stones up to six inches in their greatest dimension, unless otherwise specified. Backfill containing rock must contain enough soil to fill voids between rocks.

When backfill material is not specified on Project Plans or elsewhere in these Specifications, Contractor may backfill with the excavated material provided material consists of loam, clay, sand, gravel, or other materials than, in opinion of Engineer, are suitable for backfilling.

Backfilling shall not be done in freezing weather and it shall not be made with frozen material. No fill shall be made where material already in trench is frozen. Backfill shall not be made with material which, in Engineer's opinion, is too wet.

Where crushed stone backfill is required the crushed stone shall be No. 57 size as designated by Kentucky Department of Transportation Standards for crushed stone used in road surfacing.

4.3 Backfilling Under Pipe in Rock

Where trench is excavated in rock or shale, a 6" space below pipe shall be backfilled with approved bedding material (#9 or #11 pipe bedding, or uniform soil meeting the approval of the Engineer) to form a cushion for pipe and appurtenances.

4.5 Backfilling Over Pipe

Backfill over pipe may be placed by means of front end loaders, bulldozers or other suitable mechanical equipment provided that the pipe is not damaged or misaligned.

4.6 In Areas Subject to Vehicular Traffic

Where excavation is made through pavement, curbs, driveways, sidewalks, road shoulders, or other areas subject to vehicular traffic or supporting permanent structures, or where such areas, items or structures are undercut by excavation, entire backfill shall be crushed stone (No. 57). Crushed stone shall be carefully placed to achieve maximum density.

Where excavation is made through permanent pavements, backfill shall be placed as described above to subgrade elevation only. Remainder of backfill shall be crushed stone placed as directed to finished pavement grade to serve as temporary pavement.

The last 6 inches of backfill shall be compacted dense grade aggregate to stabilize trench cut.

From time that backfilling is complete until time permanent pavement surface is replaced or, in absence of pavement replacement, until job is accepted, Contractor shall, at direction of Engineer, water streets, roads, etc., to settle dust where excessive dust has, in opinion of Engineer, been caused by Contractor's operations. If Contractor refuses Owner shall, after 24 hours written notice through Engineer, be permitted to proceed with such work with cost to be billed to Contractor.

In Areas Not Subject to Vehicular Traffic- Where excavation is made in areas not subject to vehicular traffic or supporting permanent structures and where settlement is allowable, Contractor may backfill with approved excavated material using acceptable mechanical methods. Backfill material shall be brought up to the original ground level and shall then be mounded over to provide for additional settlement. Compaction of this backfill material will not be required, however, the Contractor shall exercise care to confine the mound to the area immediately over the trench and shall be responsible for bringing in such additional fill material as may be required from time to time during the one year warranty period to fill in areas where excessive settlement has occurred, and to re-seed these areas.

5.0 COMPLETING INSTALLATION OF LINES, STRUCTURES, ETC.

5.1 General

The Contractor shall not, without the permission of the Engineer, remove from the line of work any earth excavated therefrom which may be suitable for backfilling or surfacing until the excavation has been refilled and surfaced.

As soon as the backfilling of any excavation is completed and when in areas of existing development, the contractor must at once begin the removal of all surplus dirt except that actually necessary to provide for the settlement of the fill. He shall also remove all the pipe and other material placed or left on the street by him except material needed for the replacement of paving, and the street shall be opened up and made passable for traffic. Following the above work, the repairing and complete restoration of the street surfaces, bridged, crossings, and all places affected by the work shall be done as promptly as possible. All excavated material shall be cleared from adjacent street surfaces, gutters, sidewalks, parkways, railroads, grass plots, yards etc., and the whole work shall be left in tidy and acceptable condition. Contractor will be required to re-grass lawns or natural grounds where trenches are excavated in these locations or where Contractor has damaged lawns or natural grounds by his operations.

The engineer shall be sole authority in determining time in which rough and final clean-up shall be performed. Rough clean-up shall consist of removal of large rocks, grading of excess backfill material over pipe line or removal of said material, opening of any drainage device, restoration of any street or roadway to condition so that traffic may safely and conveniently use street or roadway, restoration of pedestrian ways to condition where pedestrians may safely and conveniently use same. Rough clean-up shall, in general, be prosecuted no later than 1 day after pipe laying and backfilling or no farther behind pipe laying operations than 1000 feet; whichever time limit is shortest shall govern. Final clean-up

consisting of pavement replacement, sidewalk replacement, removal of small rocks, hand raking with seeding, strawing, etc., of lawns and natural grounds, adjusting grade of ground over pipeline, property repair, and other items shall be prosecuted as soon as is practical after pipe has been laid and backfilled.

5.2 Final Grading and Seeding

Final Grading and Seeding shall be in compliance and equal to the Erosion Control requirements set forth in the Kentucky Transportation Cabinet's (KYTC) Standard Specifications, Section 212. Other final clean-up requirements and payment measurement for various land uses is defined in Technical Specification 02-500, Section 3.0.

The Contractor shall perform permanent seeding and final grading for areas where grass growth was damaged or destroyed by the Contractor's operation, and this work shall only be done during the period of September 1 thru April 30, unless specifically waived by the Owner. Between installation and final grading, the affected area must be stabilized by other practical methods to prevent erosion and protect the exposed areas. In areas of established lawns no rock shall be left in the top 6" of soil and the finished grade shall be equivalent to that which existed before construction began. In all cases, lawn and pasture areas shall be left neat and in a condition so that mowing is as easy and convenient as before construction began. The lawn areas and other areas disturbed by the Contractor's activities shall have ground cover restored to a condition satisfying the affected landowner and Owner.

Final Grading and Seeding requirements are as indicated below:

1. Placement of Topsoil: Where warranted and requested, topsoil shall be spread after grading and shaping of the area to receive the material is completed and seeding and protection operations are ready to begin. Spread and lightly compact the topsoil to uniform depth of approximately 6 inches over areas specified by the Owner or Engineer. Topsoil should not be placed on slopes steeper than 3:1.
2. Seed Mixture for Permanent Seeding: For permanent seeding on slopes 3:1 or less, a Type 1 seed mix shall be applied at a minimum rate of 100 pounds per acre. For steeper slopes, apply a Type 3 mix as specified in the KYTC Standard Specification 212.03.03.
Seed Mix Type 1:
 - 30% Kentucky 31 Tall Fescue
 - 20% Creeping Red Fescue
 - 35% Hard Fescue
 - 10% Ryegrass, Annual
 - 5% White Dutch Clover
3. Procedure for Permanent Seeding: Prepare a seedbed and incorporate a minimum of 100 pounds of nitrogen, 100 pounds of phosphate, 100 pounds of potash, and 3 tons of agricultural limestone per acre. Add additional fertilizer and agricultural limestone as needed. Do not apply dry agricultural Limestone when it may generate a traffic hazard. Remove all rock in the top 6" of the soil, and all dirt clods over 4 inches in diameter shall be removed from the surface of the seedbed. All seeding shall be mechanically tracked into the seedbed, utilizing a power seeder, Harley rake, cultipacker, or other approved device. For all slopes 3:1 or greater, ensure that tracking is performed up and down and not across. Seed and mulch to produce a uniform vegetation cover using the seeding rates as indicated to each application. Mulch with clean, weed free straw. Place straw to an approximate 2-inch loose depth (2 tons per acre) and anchor it into the soil by mechanically crimping it into the soil surface or applying tackifier to provide a protective cover. For the periods of March 1 through May 15 and from September 1 through November 1, the Owner will allow the option of using hydromulch at minimum rate of 1,500 pounds per acre in place of straw with tackifier. Regardless of materials used, ensure the protective cover holds until seeding is acceptably established.
4. Maintenance of Seeded Areas during Warranty Period: From the time seeding and protection work begins until the date the project is declared complete (i.e. Warranty Expiration), keep all seeded areas in good condition at all times. Promptly repair any damage to seeded areas or to mulch materials as directed.

5. Upon completion of final clean-up, the UTILITY may request that the CONTRACTOR obtain each property owner's written release, indicating the affected owner's satisfaction with final seeding, grading and/or crop damage restitution.

5.3 Pavement Replacement

In roadway or driveway areas as soon as the pipe has been installed, the trench shall be backfilled as specified and the surface replaced as indicated below:

1. Asphalt Highway or Roadways

This item of pavement restoration shall conform to the details included in the Contract Drawings. The leveling course, binder course and the surface course shall be furnished and placed in accordance with Kentucky Department of Transportation Standard Specifications.

2. Asphalt Driveway and Parking Lot Replacement.

Asphalt Driveways and Parking Lots shall be replaced equal to that existing prior to construction and shall consist of no less than 2 inches of surface course conforming to the Kentucky Department of Transportation Standard Specifications.

3. Crushed Stone Roadway Replacement or Driveway Replacement

Crushed Stone Roadways and Pavement shall be replaced to that existing prior to construction but in no case less than 6 inches in depth.

5.4 Dust Control

From time that backfilling is complete until time permanent pavement surface is replaced or, in absence of pavement replacement, until the job is accepted, Contractor shall, at direction of Engineer, water streets, roads, etc. to settle dust where excessive dust has, in opinion of Engineer, been caused by Contractor's operations. If Contractor refuses or delays unnecessarily to obey direction of Engineer, the Owner shall, after 24 hours written notice through engineer, be permitted to proceed with such work with cost to be billed to Contractor.

5.5 Sodding or Sprigging

Where shown on the Drawings or directed by engineer, contractor shall install grass sod or sprigs in lieu of seeding in order to establish ground cover. Normally this would be done in steep areas or areas otherwise subject to erosion.

Such sodding or sprigging when authorized by the engineer as a necessary part of the work and not elected to be used by the Contractor in lieu of seeding shall be a separate pay item if identified separately on the Bid Form.

Prior to sodding or sprigging, soil shall be properly prepared and fertilized. The top 3" of soil shall be pulverized to remove roots, sticks, etc. and smooth the surface. The area shall be fertilized at a minimum rate of 500 pounds per acre. Fertilizer shall be mixed into the top 3" of soil by raking, disking, or other acceptable method. Do not over fertilize areas in order to avoid damaging growth. Fertilizer shall be "Vertigreen", "Vigaro", or approved equal. It shall contain not less than 10% nitrogen, 10% phosphorus, and 10% potash. If the area soil requires adjustment of the pH for proper growth of ground cover, ground limestone shall be applied to bring the pH into the proper range.

Sod shall be at least 8" wide and 12" long with at least 3" of dirt on the roots. The variety of grass shall be suitable to the growing conditions of the area, and compatible with the adjacent grasses. It shall be placed on the prepared surfaces with edges in close contact and, as much as is practicable, in a position to break joints. Each section shall be pounded into place with wooden tamps or other approved implements. Sod shall be maintained moist from the time of its removal until reset and shall be reset as

soon as practicable after removal. Immediately after placing, it shall be rolled or hand tamped to the satisfaction of the Engineer. On steep slopes pinning or pegging will be required to hold the sod in place.

Sprigs shall be placed in a random manner at spacing suitable for optimum growth and cover as recommended by the supplier.

Immediately prior to sodding or sprigging, the area shall be sprinkled until saturated to at least 1" depth and kept moist until sodding or sprigging is completed. Sprigs or sod shall be watered as required after setting (normally through a 14-day period). Contractor shall not allow any equipment or material on any planted area and shall erect barricades and guards if necessary to prevent his equipment, labor or the public from traveling on any planted area until satisfactory growth is established.

6.0 SPECIAL CONSTRUCTION ITEMS

6.1 Roadway Crossings

Roads, streets or highways will be crossed at locations and in the manner as designated by the Drawings. State Highway crossings will be subject to the requirements of the crossing permit obtained from the Kentucky Transportation Cabinet.

When working in or near lines of traffic, the Contractor shall provide warning signals or flag men as required by Kentucky Transportation cabinet.

6.1 Sinkholes

When excavating within an area draining to a sinkhole, special precautions shall be required to avoid excessive silt runoff or debris entering the sinkhole. In such areas, the excavation shall be closed as quickly as possible and the surface restored and mulched to avoid erosion. In the immediate vicinity of sinkholes and when ordered by the Engineer, special erosion control measures as specified in Section 6.3 are to be used.

6.2 Slope Protection and Erosion Control

This section shall consist of temporary control measures as shown in the Drawings or directed by the Engineer or as required by the State of Kentucky - Water Pollution Control Division during the life of the contract to control erosion and water pollution through the use of silt fences, hay bales and other control devices.

- a. Baled hay or straw erosion checks are temporary measures to control erosion and prevent siltation. Bales shall be either hay or straw containing five (5) cubic feet or more of natural material.
- b. Baled hay or straw erosion checks - hay or straw erosion checks shall be embedded in the ground 4 to 6 inches to prevent water flowing under them. These bales shall be anchored securely to the ground by wooden stakes driven through the bales into the ground. Bales may remain in place after construction, or be removed after they have served their purpose, as determined by the Engineer. The Contractor shall keep the checks in good condition by replacing broken or damaged bales immediately after damage occurs. Normal debris and sediment clear-out will be considered routine maintenance to be performed by the contractor as needed.
- c. Temporary silt fences - Silt fences utilizing posts, filter cloth (burlap or plastic filter fabric, etc.) or other approved materials are temporary measures to erosion control. These fences shall be installed to retain suspended silt particles in the run-off-water where directed by the Engineer.
- d. The temporary erosion control features installed by the Contractor shall be acceptably maintained by the Contractor until no longer needed or permanent erosion control methods are installed. Any materials removed shall become the property of the Contractor.

- e. Erosion control outside project area - Temporary pollution control measures shall include construction work outside the project area where such work is necessary as a result of construction such as borrow pit operations, haul roads and equipment storage sited. Bid price in such cases shall include all necessary clearing and grubbing, construction incidentals, maintenance, and site restoration when no longer needed.
- f. No separate measurement and payment will be made for this work. It will be considered a subsidiary obligation of the Contractor under other bid items.

END OF SECTION 02-300

WATER MAIN MEASUREMENT AND PAYMENT LABOR BID ITEMS & SUPPLEMENTAL BID ITEMS ONLY

1.0 GENERAL

The Contractor shall furnish all labor, tools, equipment and materials to construct the proposed improvements complete as shown on the plans and described in these Specifications. The work shall be measured for payment in accordance with applicable provisions of these Specifications and payment shall be made on the basis of the unit prices or lump sum prices bid. The sum of the payments for eligible pay items contained in the proposal form shall be the compensation to be paid for the completed project; provided however, that changes in the work covered by written change orders, properly executed, may result in additions or deductions from the contract price.

The Contractor's attention is called to the fact that although the pay items shown shall be the basis for establishing the contract price, the description of the pay items does not necessarily reflect the full extent of work to be performed. The cost of the incidental work such as clearing and grubbing, trenching, backfilling, testing, etc., which is necessary but which is not specifically listed as one of the pay items, shall be included in the prices bid for the pay items to which the incidental work is most closely related.

2.0 CHANGE OUT OF EXISTING WATER METERS

- A. Measurement – Change Out of Existing Water Meters shall be measured by count of each size of meter exchanged in accordance with the contract drawings and specifications in the completed system.
- B. Payment - Payment shall be at the unit bid price for the measured quantity. Payment shall include locating the existing meter, temporarily suspending flow, removing the old meter, installing the new meter plus any accompanying communication transceiver unit, & supplying all materials and accessories required for a complete installation.

Payment shall also include delivery of all replaced meters and brass components/scrap to the Owner, and disposal of all other scrap materials by the Contractor.

3.0 MODIFICATION OF EXISTING METER BOX LID

- A. Measurement – Modification of Existing Meter Box Lids shall be measured by count of each lid modified in accordance with the contract drawings and specifications in the completed system.
- B. Payment - Payment shall be at the unit bid price for the measured quantity. Payment shall include locating the existing meter box, drilling a circular hole in the meter lid (diameter per meter manufacturer's guidelines to install a 'thru-the-lid' adapter kit), installation of the required 'thru-the-lid' adapter kit, and supplying all materials & accessories required for a complete modification.

4.0 REPLACEMENT & RECONNECTION OF EXISTING 'NEAR SIDE' METER & SERVICE

- A. Measurement – Replacement & Reconnection of existing meter & service (IF APPLICABLE) shall be measured by count **of each size** of near side service actually replaced and reconnected in accordance with the contract drawings and specifications in the completed system. Near side service means that the meter is on the same side of the road as the water main.
- B. Payment - Payment shall be at the unit bid price for the measured quantity. Payment shall include locating and disconnecting the existing service line from the water main, shutting off the existing service line, replacing the referenced meter as illustrated, replacing the PRV if presently utilized, re-using & reconnecting to the existing service saddle on the water main, up to 10 LF of

new service tubing from the tap to the meter setting, new setter, new meter box & lid, new 'thru lid install kit' for meter's radio, tracer wire main to meter, applicable fittings and piping for reconnection to the customer's existing service line, and supplying all materials and accessories required for a complete installation and reconnection of the replaced meter to the customer's service line.

Payment shall also include delivery of all replaced meters and brass components/scrap to the Owner, and disposal of all other scrap materials by the Contractor. Payment shall also include all associated ground surface restoration (performed in accordance with Specification 02-300, Section 5.2), cleanup, reseeding and straw required for a complete installation. Pavement repairs compensated separately.

5.0 REPLACEMENT & RECONNECTION OF EXISTING 'FAR SIDE' METER & SERVICE

- A. Measurement – Replacement & Reconnection of existing meter & service (IF APPLICABLE) shall be measured by count of each size of far side service actually replaced and reconnected in accordance with the contract drawings and specifications in the completed system. Far side service means that the meter is on the opposite side of the road as the water main, and that a service line road crossing is required within PVC encasement.
- B. Payment – Payment shall be at the unit bid price for the measured quantity. Payment shall include locating and disconnecting the existing service line from the water main, shutting off the existing service line, replacing the referenced meter as specified, replacing the PRV if presently utilized, re-using & reconnecting to the existing service saddle on the water main, up to 50 LF of new service tubing from the tap to the meter setting, new setter, new meter box & lid, new 'thru lid install kit' for meter's radio, tracer wire main to meter, applicable fittings and piping for reconnection to the customer's existing service line, and supplying all materials and accessories required for a complete installation and reconnection of the replaced meter to the customer's service line. For far side meters, new service tubing (matching existing size) shall be installed within a NEW PVC casing pipe beneath the affected roadway as detailed in the contract drawings.

Payment shall also include delivery of all replaced meters and brass components/scrap to the Owner, and disposal of all other scrap materials by the Contractor. Payment shall also include all associated ground surface restoration (performed in accordance with Specification 02-300, Section 5.2), cleanup, reseeding and straw required for a complete installation. Pavement repairs compensated separately.

6.0 CONCRETE PAVEMENT REPLACEMENT (IF APPLICABLE)

- A. Measurement - The replacement of concrete surfaces shall be measured for payment by surface area measurements to the nearest square foot. Measurements of disturbed surface areas (all depths) shall be verified by the Owner and/or Engineer.
- B. Payment - Payment shall be at the unit bid price for the measured quantity. Payment shall be total compensation for furnishing the concrete (matching existing depths) plus all labor, tools, steel reinforcement, equipment and materials and installing the pavement complete. Payment shall also include work such as location and protection of existing utilities, clearing, excavation (including rock), final grading, disposal of surplus excavated material. Payment shall be total compensation for saw cutting, granular backfill (as specified by surface use type), furnishing and placing all base and surfacing materials, including rolling and/or finishing, all in accordance with the plans and specifications.

7.0 ASPHALT PAVEMENT REPLACEMENT (IF APPLICABLE)

- A. Measurement - The replacement of asphalt surface shall be measured for payment by surface area measurements to the nearest square foot. Measurements of disturbed surface areas (all depths) shall be verified by the Owner and/or Engineer.

- B. Payment - Payment shall be at the unit bid price for the measured quantity. Payment shall be total compensation for the mobilization, equipment, saw cutting, granular backfill or flowable concrete fill (as specified), furnishing and placing all base and surfacing materials as specified in respective details (all depths), including rolling and finishing, for disposal of all surplus material, and for all labor, tools, equipment and incidentals necessary to complete the work, all in accordance with the plans and specifications plus in accordance with applicable standards of the Kentucky Transportation Cabinet.

8.0 CONNECTION TO EXISTING WATER MAIN WITH NEW SERVICE SADDLE (IF APPLICABLE)

- A. Measurement – Connections to existing water main with new service saddle shall be measured by count and **by size** of connections actually installed in accordance with the contract drawings and specifications in the completed system.
- A. Payment - Payment shall be at the unit bid price for the measured quantity. Payment shall include locating and excavating the existing line, shutting off the existing line if necessary, removing any old saddle, installing repair clamp and/or plug for old tap, and installing new brass service saddle with new corporation stop. Payment shall include providing fittings that may be required for the connection, backfilling, and other accessories and work necessary for a complete and working installation. Payment shall also include delivery of all replaced brass components/scrap to the Owner, and disposal of all other scrap materials by the Contractor.

9.0 ADDITIONAL ¾" HDPE SERVICE TUBING (IF APPLICABLE)

- A. Measurement - Where necessary and verified by the Engineer and/or Owner that its necessary to install additional ¾" service tubing in excess of the lengths specified in Near Side Service Reconnect Bid Item or Far Side Service Reconnects Bid Item (See paragraph 4 & 5 above), extra tubing shall be measured for payment by horizontal measurements to the nearest 1 foot.
- B. Payment - Payment shall be at the unit bid price for the measured extra quantity actually installed as required for a complete and working installation.

10.0 COMPLETE REPLACEMENT OF METER BOX & LID (IF APPLICABLE)

- A. Measurement – Where directed by the Engineer or Owner, complete replacement of a meter box & lid shall be measured by count actually installed in accordance with the contract drawings and specifications in the completed system.
- B. Payment - Payment shall be at the unit bid price for the measured quantity. Payment shall include locating the existing meter box, the new meter box & lid with pre-drilled hole (as needed per the meter manufacturer), removal of the existing meter box & lid, installation of the new meter box & lid and all accessories referenced by the plans and specifications, including excavation, installation and backfill as required for a complete and working installation.

Payment shall also include all associated ground surface restoration (performed in accordance with Specification 02-300, Section 5.2), cleanup, reseeding and straw required for a complete installation. Necessary pavement repairs compensated separately.

END OF SECTION 02-500



Presented to:
**Guthrie Water Works
 Water System**
 Guthrie, Todd County

By:
**Pennyriple Area
 Development District**

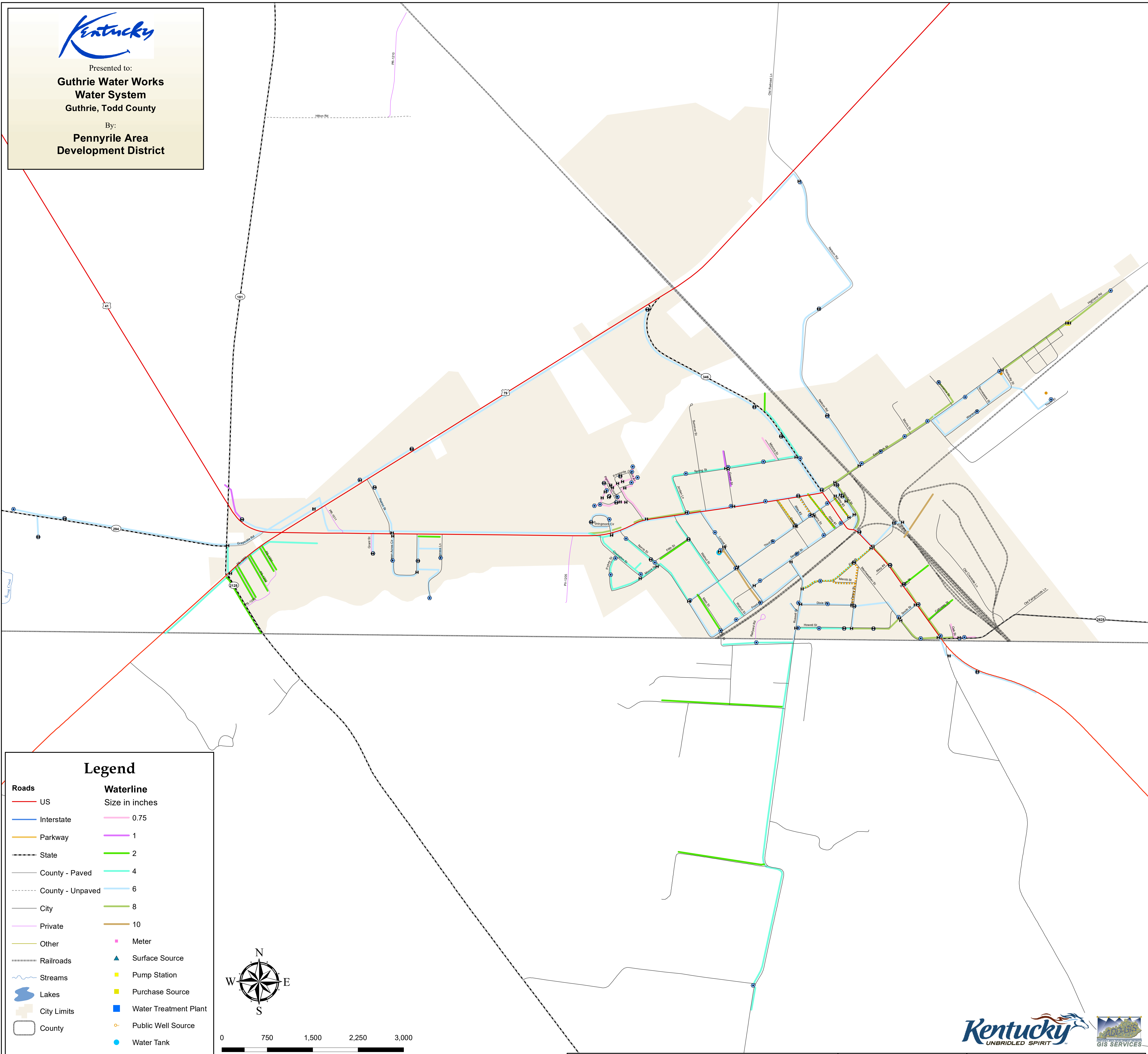

Legend

Roads	Waterline
— US	Size in inches
— Interstate	0.75
— Parkway	1
- - - State	2
— County - Paved	4
- - - County - Unpaved	6
— City	8
— Private	10
— Other	• Meter
- - - Railroads	▲ Surface Source
~ Streams	■ Pump Station
■ Lakes	■ Purchase Source
■ City Limits	■ Water Treatment Plant
□ County	○ Public Well Source
	● Water Tank
	● Water Pump
	⊕ Water Valve
	⊕ Hydrant
	● Water Project - Point
	----- Water Project - Line

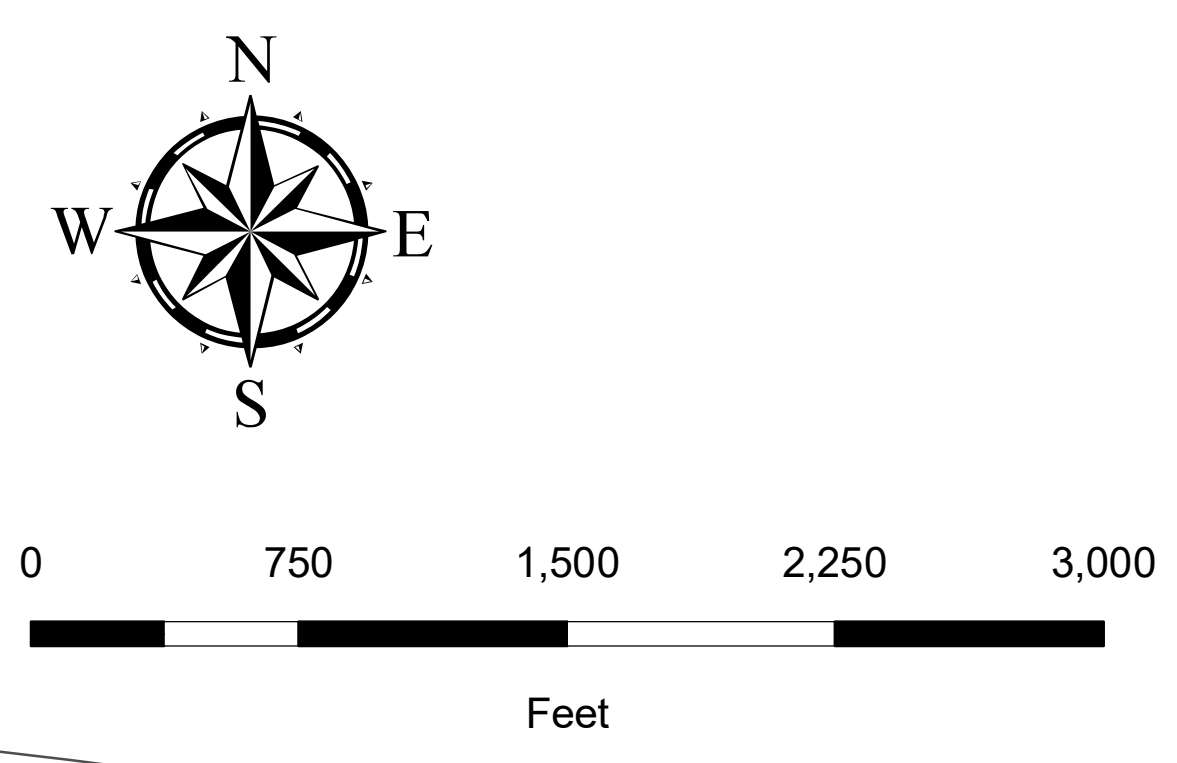

NADCON 1983 Datum based on Kentucky State Plane Coordinate System, Single Zone 1600.

Road Centerlines collected using GPS technology and KYTC (Kentucky Transportation Cabinet) standards.

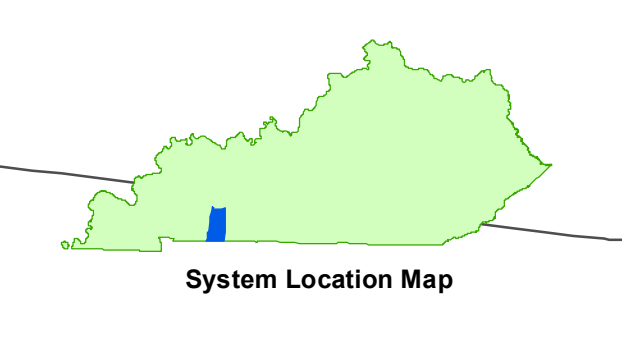

To the best of my knowledge, this planning map and associated reports are an accurate and current representation of the Guthrie Water Works water system.

Authorized Representative _____ Date _____

System Name: Guthrie Water Works

Limitation of Liability: The information contained on this map is to be used for planning purposes only. The Pennyriple Area Development District provides no warranties of any kind for the accuracy or use of this information outside the context of use for planning purposes.

Date: June 2021

Illustrated by: GIS Department

Sheet Number: 1

Project: Kentucky Infrastructure Authority (KIA)

PADD a regional planning and development agency

GIS Department
 300 Hammond Drive
 Hopkinsville, Kentucky 42240

Fax: 270-886-3211
 Phone: 270-886-9484
 www.peadd.org

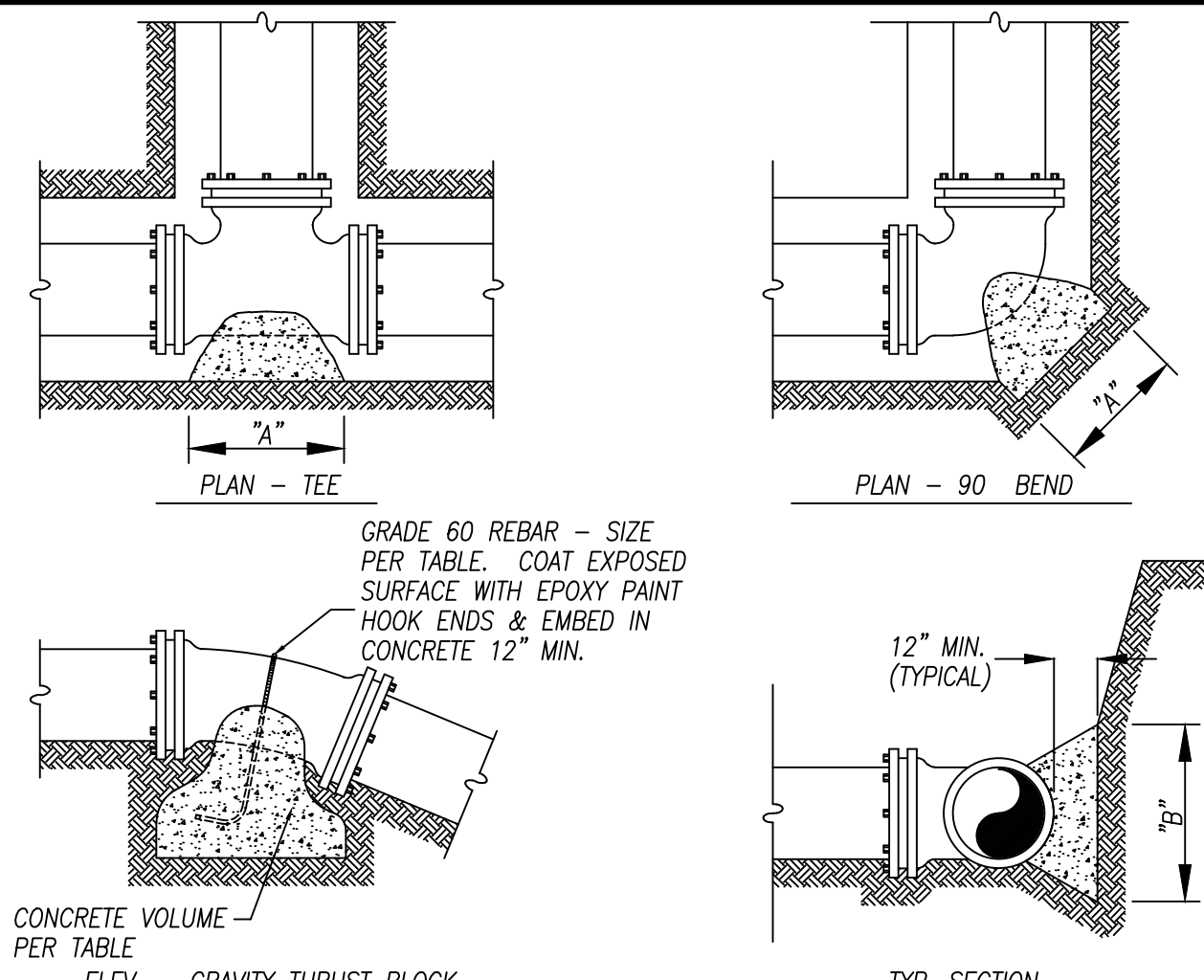

PIPE SIZE	MINIMUM BEARING AREA ("A"x"B") IN SQUARE FEET					MIN. CONC. VOLUME IN CUBIC FEET	REBAR SIZE
	TEE OR DEAD END	90° BEND	45° BEND	22 1/2° BEND	11 1/4° BEND		
2", 3" & 4"	1.0	1.5	1.0	1.0	1.0	2	1.5 #4
6"	2.5	3.0	2.0	1.0	1.0	5	3 #4
8"	4.0	5.5	3.0	1.5	1.0	8	5 #5
10"	6.0	8.5	4.5	2.5	1.5	13	9 #5
12"	8.5	12.0	6.5	3.0	2.0	18	12 2-#5
16"	15.0	21.5	11.5	6.0	3.0	32	21 2-#6

- NOTES:
- CONCRETE FOR THRUST BLOCKS SHALL HAVE A MINIMUM 28-DAY COMPRESSIVE STRENGTH OF 2,500 PSI.
 - KEEP CONCRETE CLEAR OF JOINTS, GLAND BOLTS, ETC.
 - CONCRETE THRUST BLOCKS SHALL BE CAST AGAINST SOUND, UNDISTURBED EARTH.
 - BEARING AREAS ARE BASED ON 4,000 PSF SOIL BEARING CAPACITY. WEAKER SOILS MAY REQUIRE LARGER THRUST BLOCKS.
 - THRUST BLOCK BEARING AREAS MAY BE REDUCED IN ROCK SUBJECT TO ENGINEER'S APPROVAL.
 - VALVES REQUIRE ONE REBAR STRAP AS SHOWN IN THE TABLE AT EACH END OF THE VALVE.
 - WHERE CONTRACTOR SUSPECTS THAT UNSUITABLE BEARING CONDITIONS EXIST, NOTIFY ENGINEER PRIOR TO CASTING THRUST BLOCK.
 - ALL FITTINGS SHALL BE EQUIPPED WITH GRIPRING PIPE RESTRAINER (ROMAC INDUSTRIES).

CONCRETE THRUST BLOCKS

NOT TO SCALE

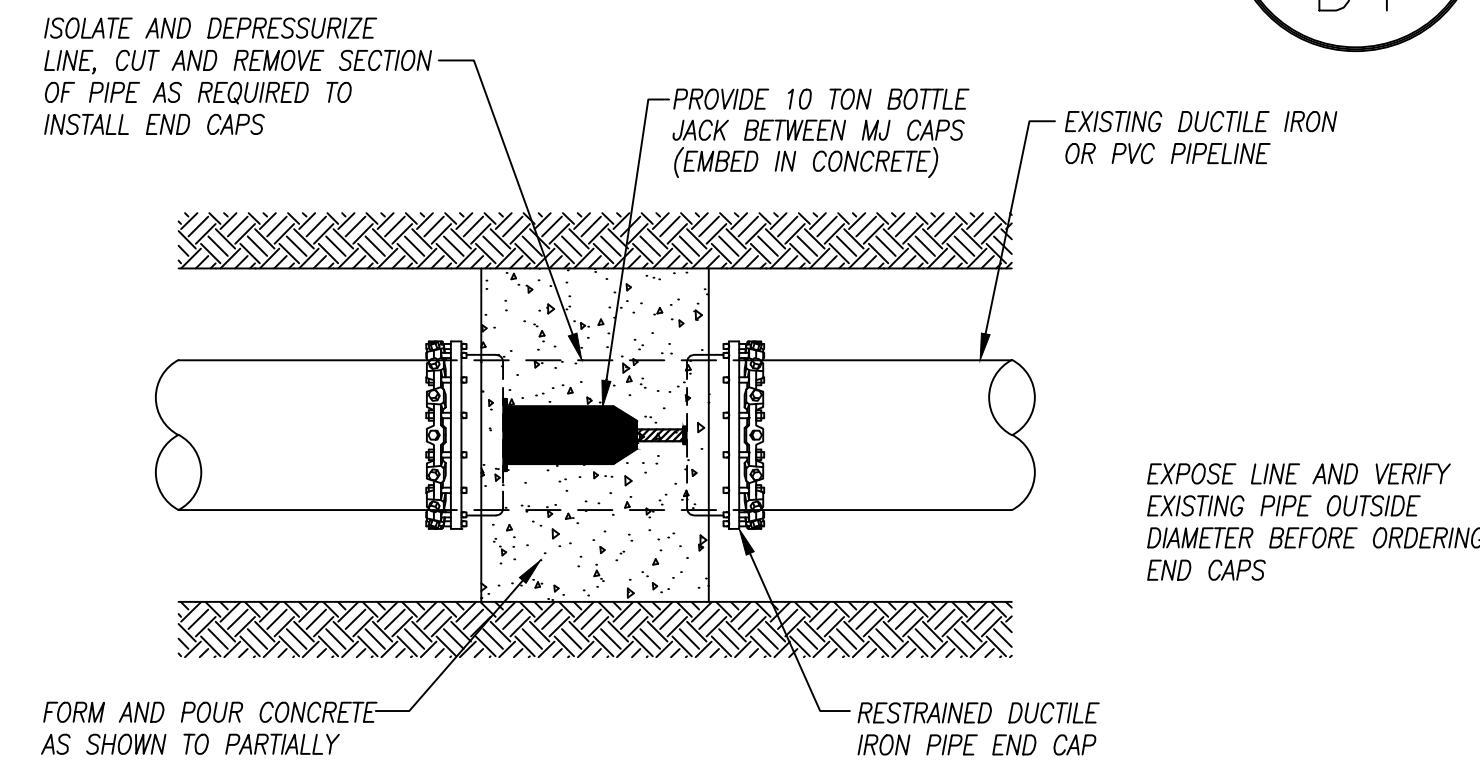

CUT & PLUG EXISTING LINE DETAIL

NOT TO SCALE

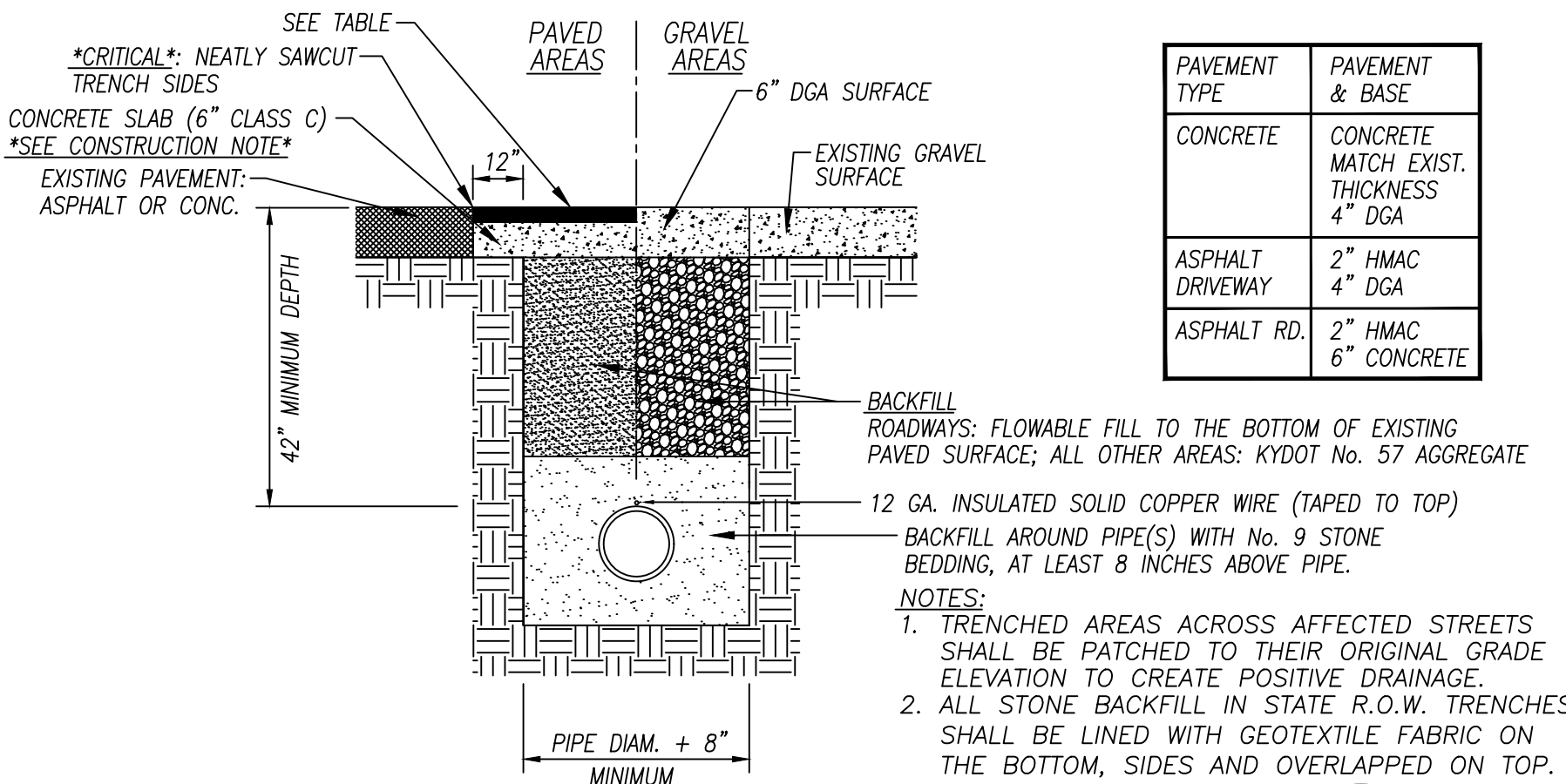

PAVEMENT BACKFILL & REPAIR

NOT TO SCALE

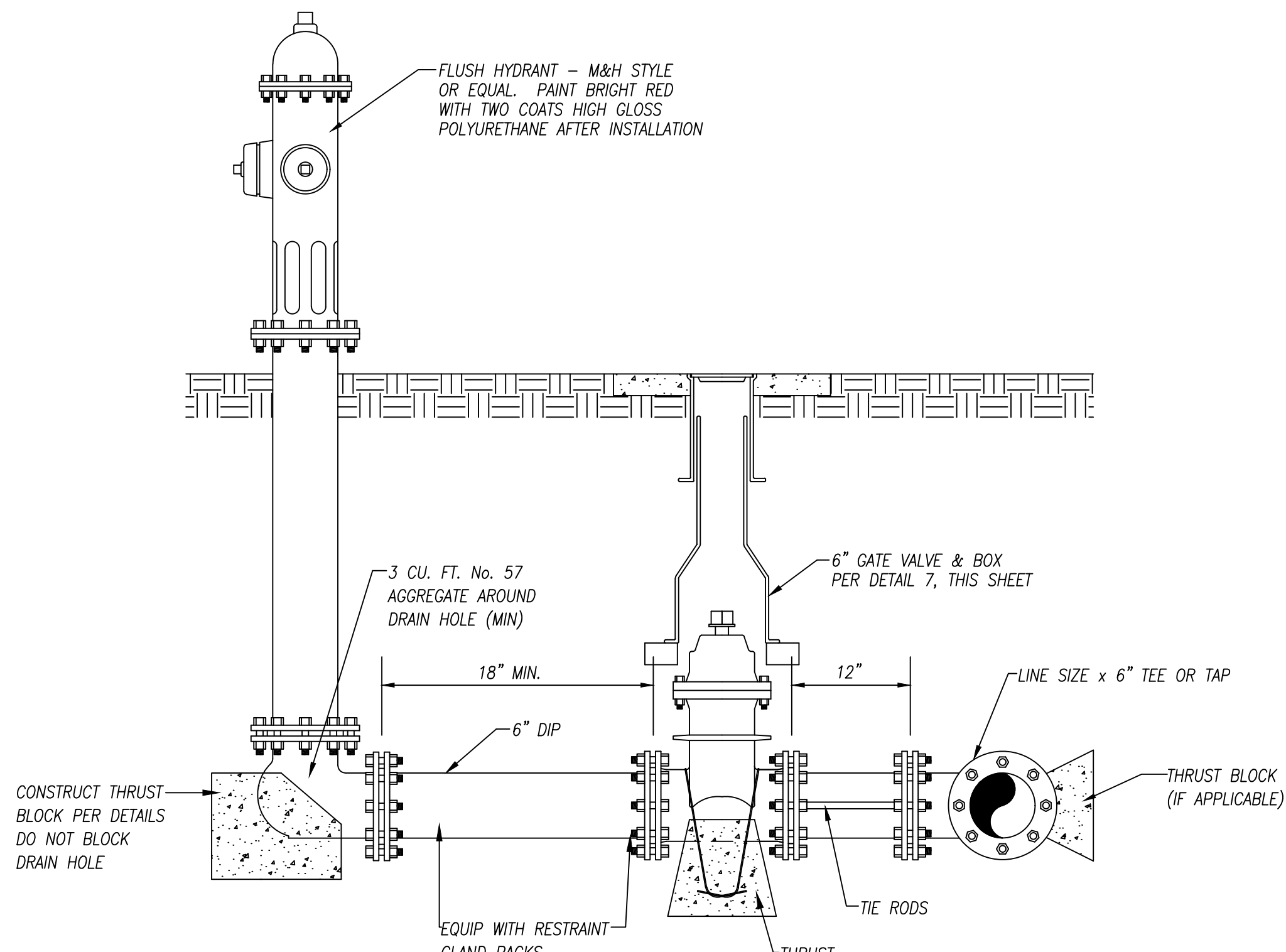

LARGE HYDRANT w/ VALVE

NOT TO SCALE

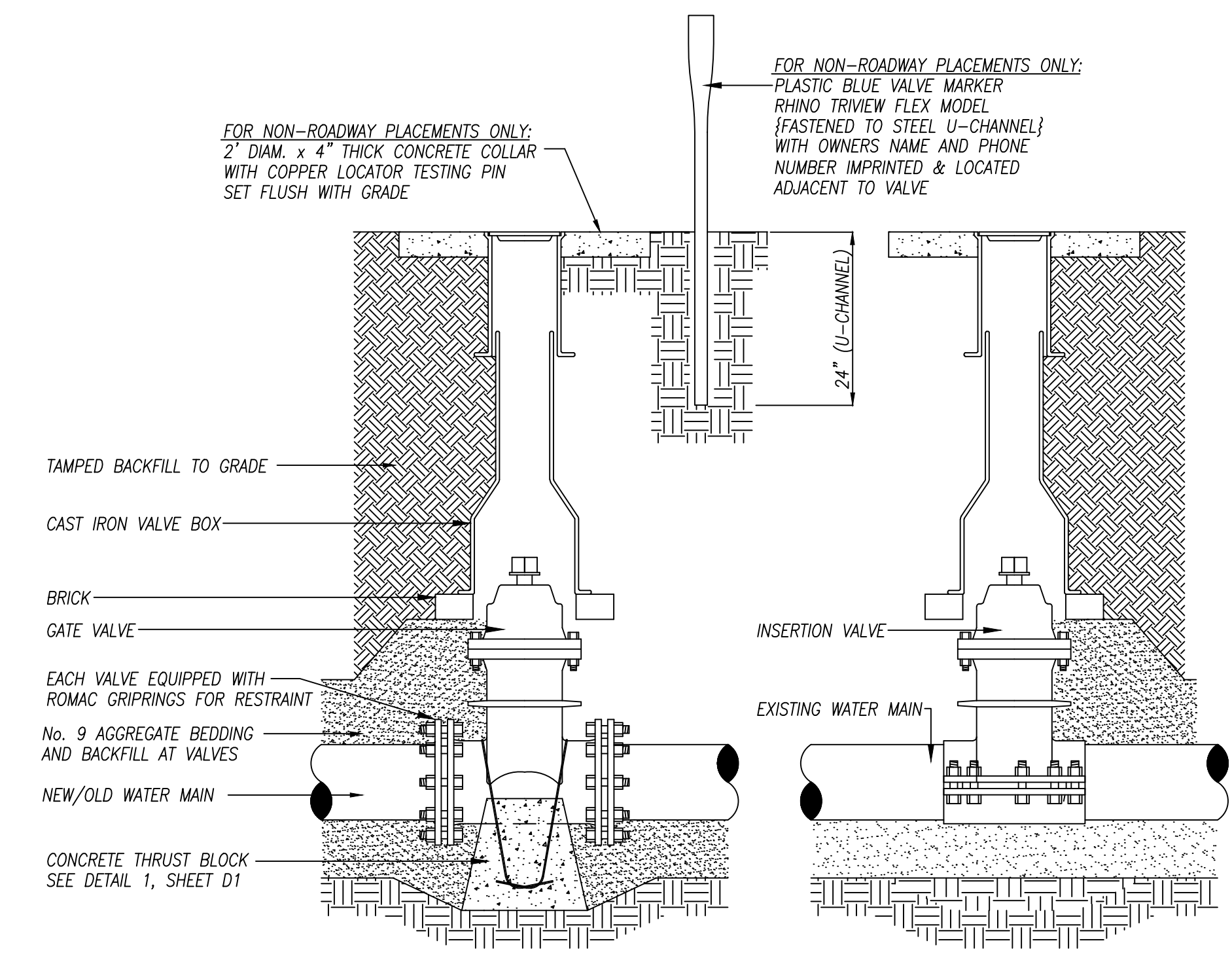

VALVE SETTING DETAIL

NOT TO SCALE

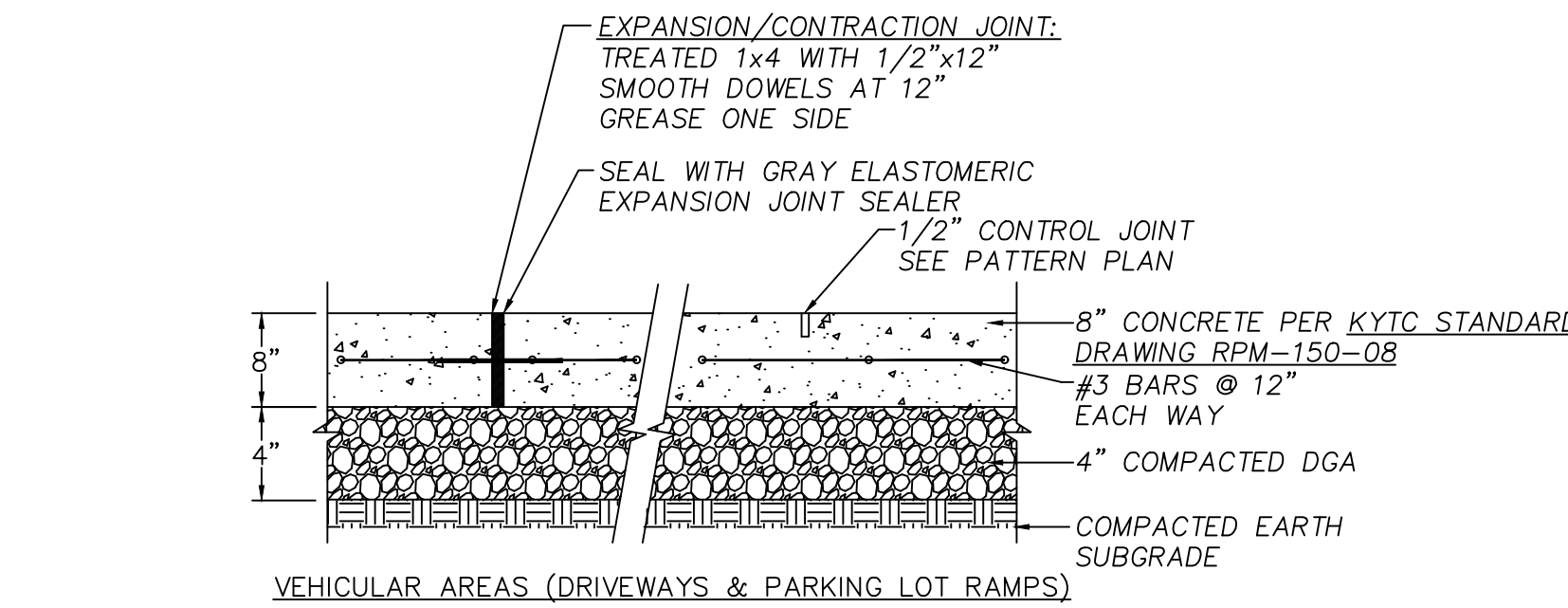

VEHICULAR AREAS (DRIVEWAYS & PARKING LOT RAMPS)

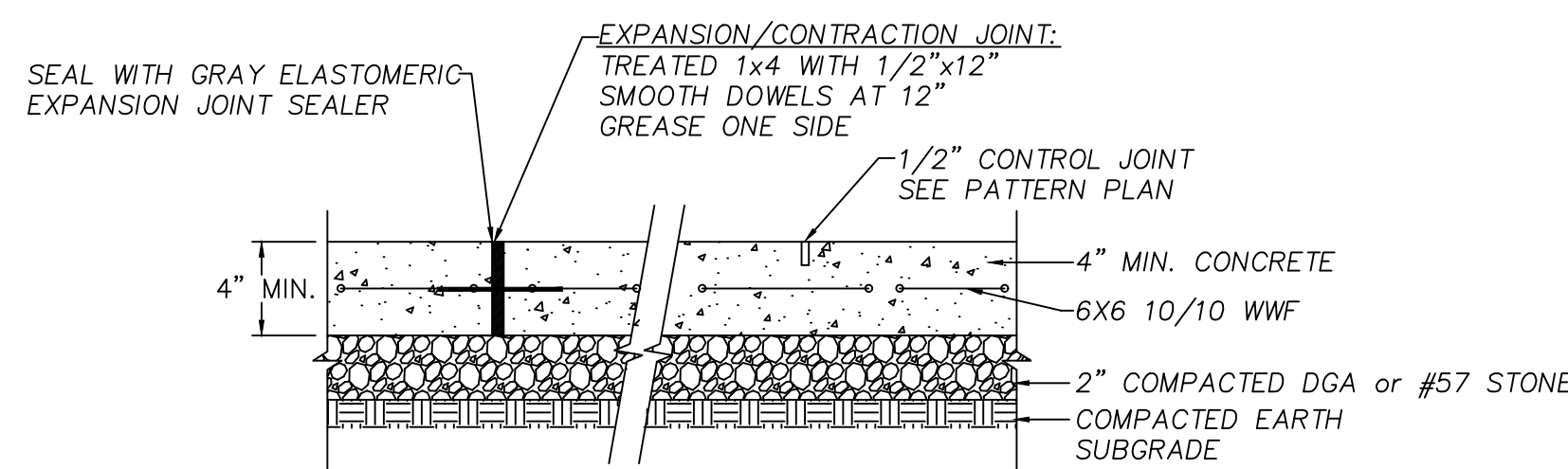

NON-VEHICULAR AREAS

Typical Sections CONCRETE SIDEWALK DETAIL

NOT TO SCALE

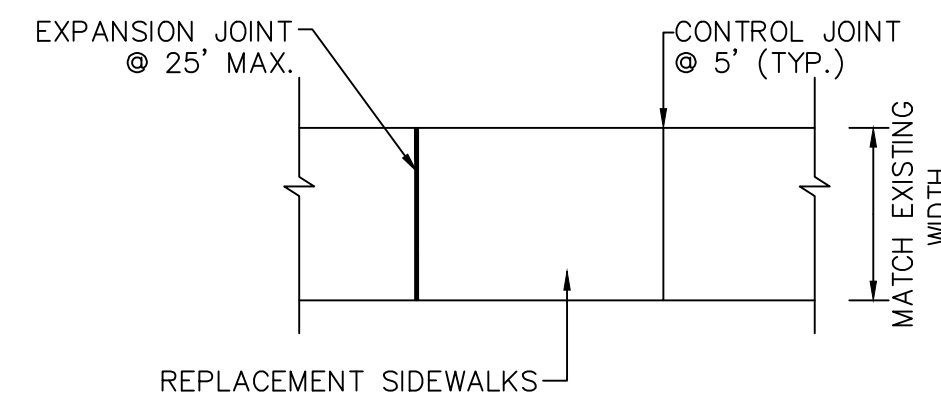

Typical Sidewalk Pattern CONCRETE PAVING PLAN

NOT TO SCALE

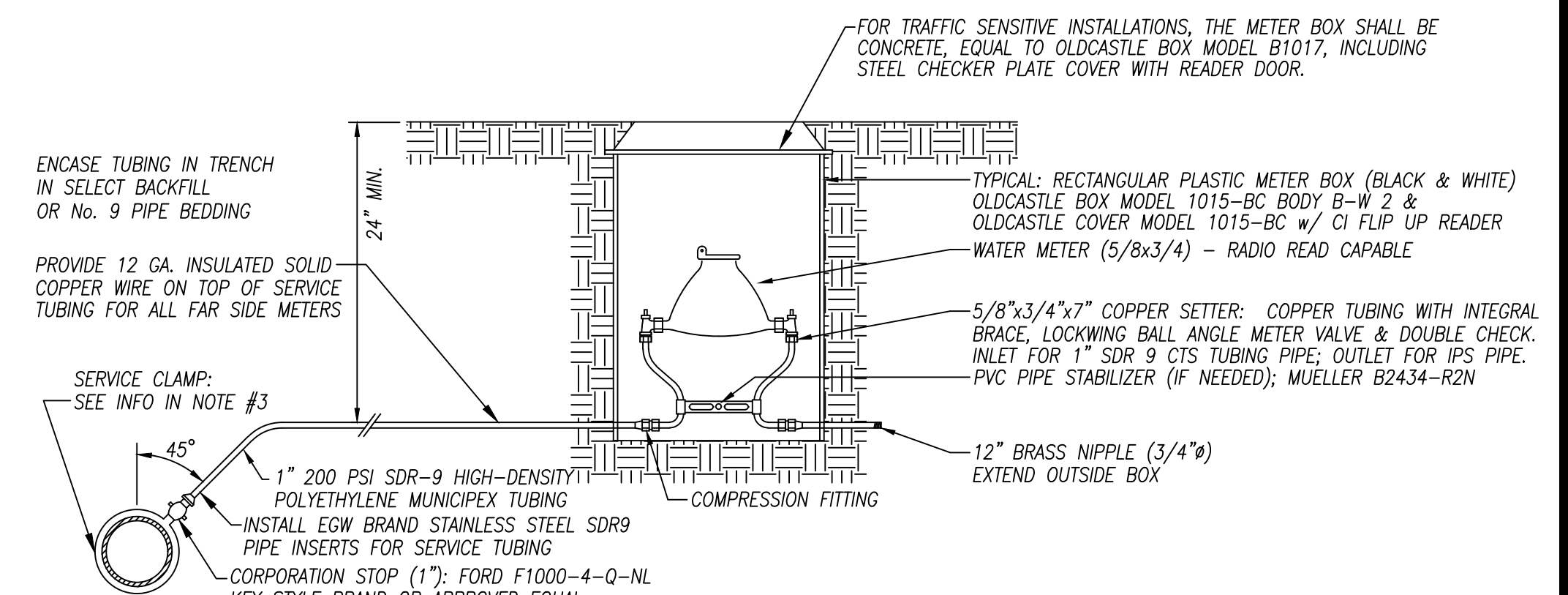

METER SERVICE SETTING REPLACEMENT

NOT TO SCALE

- CONSTRUCTION NOTES:
- ENCASE FAR SIDE METER SERVICE TUBING WITHIN 1-1/2" PVC CASING PIPE UNDER ROADS.
 - WHERE SERVICE TUBING CROSSES A ROAD OR DRIVE, BORE DITCHLINE TO DITCHLINE AND MAINTAIN 42" MIN. COVER BETWEEN THE LOWEST ROAD POINT & TOP OF CASING PIPE.
 - SERVICE CLAMP: C900 PVC WATER MAINS = FORD S90-804 1" HINGED BRASS SADDLE. CAST/DIP WATER MAINS = NYLON COATED DUCTILE WITH NITRIL O-RING GASKET w/ STAINLESS STRAPS.
 - NO BORE PIT SHALL BE EXCAVATED CLOSER THAN 10' FROM THE PAVEMENT EDGE. NO SPOIL MATERIAL SHALL BE STORED CLOSER THAN 10' FROM THE PAVEMENT EDGE.

NO.	REVISION	DATE	BY
1	FOR CONSTRUCTION	10-21-22	CWW

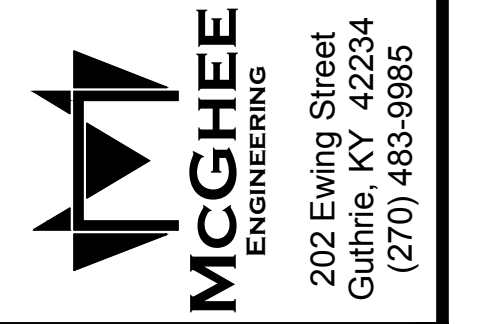
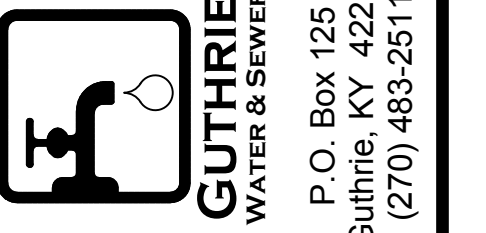

DESIGN BY: CWW
CHK BY: CWW
APP BY: AS SHOWN
SCALE: AS SHOWN
PROJECT DATE: 2022
PRINTED: ON ORIGINAL DRAWING
LENGTH OF BAR IS 1"

City of Guthrie, Kentucky
CITY-WIDE METER
CHANGE OUT PROJECT
Miscellaneous Water Details

